

European Committee for drawing up Standards in the field of Inland Navigation
(CESNI)

Edition 2025/1

**European Standard
laying down
Technical Requirements
for
Inland Navigation vessels
(ES-TRIN)**

TABLE OF CONTENTS

PART I GENERAL	1
CHAPTER 1 GENERAL	1
Article 1.01 Definitions	1
Article 1.02 Instructions for the application of this Standard	10
CHAPTER 2 PROCEDURE	11
PART II PROVISIONS REGARDING SHIPBUILDING, FITTING OUT AND EQUIPMENT	13
CHAPTER 3 SHIPBUILDING REQUIREMENTS	13
Article 3.01 Basic rules	13
Article 3.02 Strength and stability	13
Article 3.03 Hull	14
Article 3.04 Engine and boiler rooms, bunkers	16
CHAPTER 4 SAFETY CLEARANCE, FREEBOARD AND DRAUGHT SCALES	17
Article 4.01 Safety clearance	17
Article 4.02 Freeboard	17
Article 4.03 Draught marks	19
Article 4.04 Draught scales	21
Article 4.05 Specific requirements applicable to vessels navigating on zone 4 waterways	22
CHAPTER 5 MANOEUVRABILITY	23
Article 5.01 General	23
Article 5.02 Navigation tests	23
Article 5.03 Test area	23
Article 5.04 Degree of loading of vessels and convoys during navigation tests	23
Article 5.05 Use of on-board facilities for navigation test	24
Article 5.06 Prescribed (forward) speed	24
Article 5.07 Stopping capacity	24
Article 5.08 Capacity for going astern	24
Article 5.09 Capacity for taking evasive action	25
Article 5.10 Turning capacity	25
CHAPTER 6 STEERING SYSTEM	27
Article 6.01 General requirements	27
Article 6.02 Steering apparatus drive unit	27
Article 6.03 Hydraulic steering apparatus drive unit	28
Article 6.04 Power source	28
Article 6.05 Manual drive	28
Article 6.06 Rudder-propeller, water-jet, cycloidal-propeller and bow-thruster systems	29
Article 6.07 Indicators and monitoring devices	29
Article 6.08 Rate-of-turn regulators	29
Article 6.09 Testing	30
CHAPTER 7 WHEELHOUSE	31
Article 7.01 General	31
Article 7.02 Unobstructed view	31
Article 7.03 General requirements concerning control, indicating and monitoring equipment	32
Article 7.04 Specific requirements concerning control, indicating and monitoring equipment of main engines and steering systems	33
Article 7.05 Navigation lights, light signals and sound signals	35
Article 7.06 Navigation and information equipment	36
Article 7.07 Radio telephony systems for vessels with steering positions designed for radar navigation by one person	36
Article 7.08 Internal communication facilities on board	36
Article 7.09 Alarm system	37

<i>Article 7.10 Heating and ventilation</i>	37
<i>Article 7.11 Stern-anchor operating equipment</i>	37
<i>Article 7.12 Elevating wheelhouses</i>	37
<i>Article 7.13 Entry in the inland navigation vessel certificate for vessels with steering positions designed for radar navigation by one person</i>	38
<i>Article 7.14 Retractable wheelhouses</i>	39
CHAPTER 8 ENGINE DESIGN	41
<i>Article 8.01 General</i>	41
<i>Article 8.02 Safety equipment</i>	41
<i>Article 8.03 Propulsion systems</i>	42
<i>Article 8.04 Engine exhaust system</i>	42
<i>Article 8.05 Fuel tanks, pipes and accessories</i>	43
<i>Article 8.06 Storage of lubricating oil, pipes and accessories</i>	44
<i>Article 8.07 Storage of oils used in power transmission systems, control and activating systems and heating systems, pipes and accessories</i>	45
<i>Article 8.08 Bilge pumping and drainage systems</i>	46
<i>Article 8.09 Oily water and used oil stores</i>	47
<i>Article 8.10 Noise emitted by vessels</i>	48
CHAPTER 9 EMISSION OF GASEOUS AND PARTICULATE POLLUTANTS FROM INTERNAL COMBUSTION ENGINES.....	49
<i>Article 9.00 Definitions</i>	49
<i>Article 9.01 General provisions</i>	49
<i>Article 9.02 Entry in the inland navigation vessel certificate</i>	50
<i>Article 9.03 Provisions for the installation of internal combustion engines</i>	50
<i>Article 9.04 Engine manufacturer's instructions</i>	50
<i>Article 9.05 Tests of the internal combustion engines</i>	51
<i>Article 9.06 Installation tests</i>	51
<i>Article 9.07 Intermediate tests</i>	52
<i>Article 9.08 Special tests</i>	52
<i>Article 9.09 Specific requirements concerning exhaust gas after treatment systems</i>	52
<i>Article 9.10 Repair of engines in service</i>	53
CHAPTER 10 ELECTRICAL EQUIPMENT AND INSTALLATIONS	55
<i>Article 10.01 General</i>	55
<i>Article 10.02 Electricity supply systems</i>	55
<i>Article 10.03 Protection against access to hazardous parts, against solid foreign objects, against ingress of water</i>	56
<i>Article 10.04 Protection from explosion</i>	57
<i>Article 10.05 Earthing</i>	58
<i>Article 10.06 Maximum permissible voltages</i>	59
<i>Article 10.07 Distribution systems</i>	60
<i>Article 10.08 Connection to the shore or other external networks</i>	60
<i>Article 10.09 Power supply to other craft</i>	61
<i>Article 10.10 Generators, engines and transformers</i>	61
<i>Article 10.11 Batteries, Accumulators and their charging devices</i>	62
<i>Article 10.12 Switchgear and controlgear</i>	64
<i>Article 10.13 Emergency circuit-breaker devices</i>	66
<i>Article 10.14 Installation fittings</i>	66
<i>Article 10.15 Cables, insulated cables and cable systems</i>	66
<i>Article 10.16 Lighting installations</i>	68
<i>Article 10.17 Navigation lights</i>	68
<i>Article 10.18 Power electronics</i>	68
<i>Article 10.19 Alarm and safety systems for mechanical installations</i>	69
<i>Article 10.20 Test conditions for electronic installations</i>	70
<i>Article 10.21 Electromagnetic compatibility</i>	71

CHAPTER 11 SPECIAL PROVISIONS APPLICABLE TO ELECTRIC PROPULSION SYSTEMS	73
Article 11.00 Definitions.....	73
Article 11.01 General provisions for electric propulsion systems.....	73
Article 11.02 Generators, transformers and switchgear for electric propulsion systems	74
Article 11.03 Electric propulsion engines for electric propulsion systems.....	74
Article 11.04 Power electronics for electric propulsion systems	75
Article 11.05 Monitoring equipment.....	75
Article 11.06 Control, regulation and automatic power limitation	75
Article 11.07 Protection of the electric propulsion systems.....	75
Article 11.08 Testing of the electric propulsion systems	76
CHAPTER 12 ELECTRONIC EQUIPMENT AND SYSTEMS	79
CHAPTER 13 EQUIPMENT	81
Article 13.01 Anchor equipment	81
Article 13.02 Other equipment.....	83
Article 13.03 Portable fire extinguishers.....	85
Article 13.04 Permanently installed firefighting systems for protecting accommodation spaces, wheelhouses and passenger rooms.....	86
Article 13.05 Permanently installed firefighting systems for protecting engine rooms, boiler rooms and pump rooms.....	87
Article 13.06 Permanently installed firefighting systems for protecting objects	94
Article 13.07 Ship's boats	95
Article 13.08 Lifebuoys and lifejackets	96
CHAPTER 14 SAFETY AT WORK STATIONS	97
Article 14.01 General.....	97
Article 14.02 Protection against falling	97
Article 14.03 Dimensions of work stations.....	98
Article 14.04 Side decks.....	98
Article 14.05 Access to work stations.....	98
Article 14.06 Exits and emergency exits	99
Article 14.07 Ladders, steps and similar devices	99
Article 14.08 Interior rooms	99
Article 14.09 Protection against noise and vibration	100
Article 14.10 Hatch covers.....	100
Article 14.11 Winches.....	101
Article 14.12 Cranes.....	101
Article 14.13 Storing flammable liquids	102
CHAPTER 15 ACCOMMODATION	103
Article 15.01 General.....	103
Article 15.02 Special design requirements for accommodation	103
Article 15.03 Sanitary installations	105
Article 15.04 Galleys.....	105
Article 15.05 Potable water installations.....	105
Article 15.06 Heating and ventilation.....	106
Article 15.07 Other accommodation installations	106
CHAPTER 16 FUEL-FIRED HEATING, COOKING AND REFRIGERATING EQUIPMENT	109
Article 16.01 General.....	109
Article 16.02 Use of liquid fuels, oil-fired equipment	109
Article 16.03 Vaporising oil burner stoves and atomising oil burner heating appliances	109
Article 16.04 Vaporising oil burner stoves.....	110
Article 16.05 Atomising oil burner heating appliances	110
Article 16.06 Forced-air heating appliances.....	111
Article 16.07 Solid fuel heating.....	111

CHAPTER 17 LIQUEFIED GAS INSTALLATIONS FOR DOMESTIC PURPOSES	113
Article 17.01 General.....	113
Article 17.02 Installations.....	113
Article 17.03 Receptacles.....	113
Article 17.04 Location and arrangement of supply units	113
Article 17.05 Spare and empty receptacles.....	114
Article 17.06 Pressure regulators	114
Article 17.07 Pressure	115
Article 17.08 Piping and flexible tubes	115
Article 17.09 Distribution system	115
Article 17.10 Gas-consuming appliances and their installation.....	116
Article 17.11 Ventilation and evacuation of combustion gases.....	116
Article 17.12 Operating instructions	117
Article 17.13 Testing.....	117
Article 17.14 Test conditions	117
Article 17.15 Attestation.....	118
CHAPTER 18 ON-BOARD SEWAGE TREATMENT PLANTS	119
Article 18.00 Definitions.....	119
Article 18.01 General provisions	120
Article 18.02 Application for type-approval.....	122
Article 18.03 Type approval procedure	122
Article 18.04 Amendment of type-approvals	123
Article 18.05 Conformity of the type-approval	123
Article 18.06 Checking of serial numbers.....	124
Article 18.07 Conformity of production	124
Article 18.08 Non-conformity with the type-approved on-board sewage treatment plant type	125
Article 18.09 Installation and performance test	125
Article 18.10 Random sample measurement / Special test	125
Article 18.11 Operation management manual and instructions	127
PART III SPECIAL PROVISIONS	129
CHAPTER 19 SPECIAL PROVISIONS APPLICABLE TO PASSENGER VESSELS	129
Article 19.01 General provisions	129
Article 19.02 Hull	130
Article 19.03 Stability.....	132
Article 19.04 Safety clearance and freeboard.....	138
Article 19.05 Maximum permitted number of passengers.....	138
Article 19.06 Passenger rooms and areas	139
Article 19.07 Propulsion system.....	143
Article 19.08 Safety devices and equipment.....	144
Article 19.09 Life-saving equipment	145
Article 19.10 Electrical Equipment.....	147
Article 19.11 Fire protection	148
Article 19.12 Fire-fighting.....	155
Article 19.13 Safety organisation.....	157
Article 19.14 Waste water collection and disposal facilities	159
Article 19.15 Derogations for certain passenger vessels.....	159
CHAPTER 20 SPECIAL PROVISIONS APPLICABLE TO PASSENGER SAILING VESSELS NOT NAVIGATING ON THE RHINE (ZONE R).....	163
Article 20.01 Application of Parts II and III	163
Article 20.02 Exceptions for certain passenger sailing vessels.....	163
Article 20.03 Stability requirements for vessels under sail.....	163
Article 20.04 Shipbuilding and mechanical requirements	164
Article 20.05 Rigging in general	164
Article 20.06 Masts and spars in general	165
Article 20.07 Special provisions for masts.....	165
Article 20.08 Special provisions for topmasts.....	166

<i>Article 20.09 Special provisions for bowsprits</i>	167
<i>Article 20.10 Special provisions for jib-booms</i>	167
<i>Article 20.11 Special provisions for main booms</i>	168
<i>Article 20.12 Special provisions for gaffs</i>	168
<i>Article 20.13 General provisions for standing and running rigging</i>	169
<i>Article 20.14 Special provisions for standing rigging</i>	169
<i>Article 20.15 Special provisions for running rigging</i>	170
<i>Article 20.16 Fittings and parts of the rigging</i>	171
<i>Article 20.17 Sails</i>	172
<i>Article 20.18 Equipment</i>	172
<i>Article 20.19 Testing</i>	172
CHAPTER 21 SPECIAL PROVISIONS APPLICABLE TO CRAFT INTENDED TO FORM PART OF A PUSHED OR TOWED CONVOY OR OF A SIDE-BY-SIDE FORMATION	173
<i>Article 21.01 Craft suitable for pushing</i>	173
<i>Article 21.02 Craft suitable for being pushed</i>	173
<i>Article 21.03 Craft suitable for propelling side-by-side formations</i>	174
<i>Article 21.04 Craft suitable for being propelled in convoys</i>	174
<i>Article 21.05 Craft suitable for towing</i>	174
<i>Article 21.06 Navigation tests on convoys</i>	174
<i>Article 21.07 Entries on the inland navigation vessel certificate</i>	175
CHAPTER 22 SPECIAL PROVISIONS APPLICABLE TO FLOATING EQUIPMENT.....	177
<i>Article 22.01 General</i>	177
<i>Article 22.02 Derogations</i>	177
<i>Article 22.03 Additional requirements</i>	178
<i>Article 22.04 Residual safety clearance</i>	178
<i>Article 22.05 Residual freeboard</i>	178
<i>Article 22.06 Heeling test</i>	179
<i>Article 22.07 Proof of stability</i>	179
<i>Article 22.08 Proof of stability in the case of reduced residual freeboard</i>	181
<i>Article 22.09 Draught marks and draught scales</i>	182
<i>Article 22.10 Floating equipment without proof of stability</i>	182
CHAPTER 23 SPECIAL PROVISIONS APPLICABLE TO WORKSITE CRAFT	183
<i>Article 23.01 Operating conditions</i>	183
<i>Article 23.02 Application of Part II</i>	183
<i>Article 23.03 Derogations</i>	183
<i>Article 23.04 Safety clearance and freeboard</i>	184
<i>Article 23.05 Ship's boats</i>	184
CHAPTER 24 SPECIAL PROVISIONS APPLICABLE TO TRADITIONAL CRAFT	185
<i>Article 24.01 Application of Parts II and III</i>	185
<i>Article 24.02 Recognition and entry in the inland navigation vessel certificate</i>	185
<i>Article 24.03 Other provisions and requirements</i>	187
CHAPTER 25 SPECIAL PROVISIONS APPLICABLE TO SEA-GOING VESSELS	189
<i>Article 25.01 Provisions for the Rhine (Zone R)</i>	189
CHAPTER 26 SPECIAL PROVISIONS APPLICABLE TO RECREATIONAL CRAFT	191
<i>Article 26.01 Application of Part II</i>	191
CHAPTER 27 SPECIAL PROVISIONS APPLICABLE TO VESSELS CARRYING CONTAINERS	193
<i>Article 27.01 General</i>	193
<i>Article 27.02 Limit conditions and method of calculation for proof of stability for the transport of non-secured containers</i>	193
<i>Article 27.03 Limit conditions and method of calculation for proof of stability for the transport of secured containers</i>	196
<i>Article 27.04 Procedure for assessing stability on board</i>	197
CHAPTER 28 SPECIAL PROVISIONS APPLICABLE TO CRAFT LONGER THAN 110 M.....	199
<i>Article 28.01 Application of Part II</i>	199
<i>Article 28.02 Strength</i>	199

<i>Article 28.03 Buoyancy and stability</i>	199
<i>Article 28.04 Additional requirements</i>	202
CHAPTER 29 SPECIAL PROVISIONS APPLICABLE TO HIGH-SPEED VESSELS	205
<i>Article 29.01 General</i>	205
<i>Article 29.02 Application of Parts II and III</i>	205
<i>Article 29.03 Seats and safety belts</i>	206
<i>Article 29.04 Freeboard</i>	206
<i>Article 29.05 Buoyancy, stability and subdivision</i>	206
<i>Article 29.06 Wheelhouse</i>	206
<i>Article 29.07 Additional equipment</i>	207
<i>Article 29.08 Enclosed areas</i>	207
<i>Article 29.09 Exits and escape routes</i>	208
<i>Article 29.10 Fire protection and fire-fighting</i>	208
CHAPTER 30 SPECIAL PROVISIONS APPLICABLE TO CRAFT EQUIPPED WITH PROPULSION OR AUXILIARY SYSTEMS OPERATING ON FUELS WITH A FLASHPOINT EQUAL TO OR LOWER THAN 55 °C	209
<i>Article 30.00 Definition</i>	209
<i>Article 30.01 Scope of application</i>	209
<i>Article 30.02 General</i>	209
<i>Article 30.03 Tasks of the inspection body and technical service, documentation</i>	210
<i>Article 30.04 Risk assessment</i>	211
<i>Article 30.05 Safety organisation</i>	213
<i>Article 30.06 Marking</i>	214
<i>Article 30.07 Independent propulsion</i>	214
<i>Article 30.08 Fire safety</i>	214
<i>Article 30.09 Electrical installations</i>	214
<i>Article 30.10 Control, monitoring and safety systems</i>	214
<i>Article 30.11 Testing</i>	215
CHAPTER 31 SPECIAL PROVISIONS APPLICABLE TO VESSELS SAILING WITH MINIMUM CREW	217
<i>Article 31.01 Vessels' equipment</i>	217
<i>Article 31.02 Standard S1</i>	217
<i>Article 31.03 Standard S2</i>	218
PART IV TRANSITIONAL PROVISIONS	219
CHAPTER 32 TRANSITIONAL PROVISIONS FOR CRAFT NAVIGATING ON THE RHINE (ZONE R)	219
<i>Article 32.01 Applicability of transitional provisions to craft which are already in service</i>	219
<i>Article 32.02 Transitional provisions for craft which are already in service</i>	219
<i>Article 32.03 Additional transitional provisions for craft which were laid down on or before 1 April 1976</i>	245
<i>Article 32.04 Other transitional provisions</i>	248
<i>Article 32.05 Transitional provisions for craft not covered by Article 32.01</i>	249
<i>Article 32.06 Ship's boats which were on board craft before 1.10.2003</i>	270
CHAPTER 33 TRANSITIONAL PROVISIONS FOR CRAFT OPERATING EXCLUSIVELY ON WATERWAYS OUTSIDE THE RHINE (ZONE R).....	273
<i>Article 33.01 Applicability of transitional provisions to craft which are already in service</i>	273
<i>Article 33.02 Transitional provisions for craft which are already in service</i>	273
<i>Article 33.03 Additional transitional provisions for craft which were laid down before 1 January 1985</i>	296
<i>Article 33.04 Ship's boats which were on board craft before 1.1.2009</i>	299
<i>Article 33.05 Other transitional provisions</i>	300

EUROPEAN STANDARD ANNEXES.....	301
PART I VESSEL IDENTIFICATION AND REGISTER	303
ANNEX 1 MODEL OF THE UNIQUE EUROPEAN VESSEL IDENTIFICATION NUMBER (ENI)	303
ANNEX 2 DATA FOR THE IDENTIFICATION OF A VESSEL.....	305
ANNEX 3 MODELS OF INLAND NAVIGATION VESSEL CERTIFICATES AND MODEL OF REGISTER OF INLAND NAVIGATION VESSEL CERTIFICATES	307
Section I Model of inland navigation vessel certificate.....	307
Section II Model of provisional inland navigation vessel certificate	321
Section III Model of supplementary Union inland navigation certificate.....	323
Section IV Model of certificate for sea-going vessel operating on the Rhine.....	325
Section V Model annex “Traditional craft” to the inland navigation certificate according to Chapter 24.....	327
Section VI Model of register of inland navigation vessel certificates	329
PART II ADDITIONAL REQUIREMENTS FOR SPECIFIC EQUIPMENT USED ON BOARD.....	333
ANNEX 4 SAFETY SIGNS.....	333
ANNEX 5 NAVIGATION AND INFORMATION EQUIPMENT	337
Section I Minimum requirements and test conditions for navigational radar installations in inland navigation	339
Section II Minimum requirements and test conditions for rate-of-turn indicators in inland navigation	343
Section III Requirements for installation and performance tests for navigational radar installations and rate-of-turn indicators in inland navigation	353
Section IV Minimum requirements, requirements for installation and performance tests for Inland AIS equipment in inland navigation	357
Section V Minimum requirements, requirements for installation and performance tests for tachographs in inland navigation.....	359
Section VI Installation and performance certificate for navigational radar installations, rate-of- turn indicators, for Inland AIS equipment and for tachographs in inland navigation.....	363
ANNEX 6 (LEFT VOID).....	365
ANNEX 7 ON-BOARD SEWAGE TREATMENT PLANTS	367
Section I Supplementary provisions	369
Section II Information Document No ... relating to type-approval of on-board sewage treatment plants intended for installation in inland waterway vessels.....	373
Section III Type approval certificate	375
Section IV Type approvals numbering system.....	381
Section V Summary of type-approvals for on-board sewage treatment plant types.....	383
Section VI Summary of on-board sewage treatment plants manufactured.....	385
Section VII Data sheet for on-board sewage treatment plants with type-approval.....	387
Section VIII Test report for on-board sewage treatment plants.....	389
Section IX Test procedure	391
ANNEX 8 SUPPLEMENTARY PROVISIONS APPLICABLE TO CRAFT EQUIPPED WITH PROPULSION OR AUXILIARY SYSTEM OPERATING ON FUELS WITH A FLASHPOINT EQUAL TO OR LOWER THAN 55 °C	403
Section I Definitions.....	405
Section II Fuel storage.....	409
Section III Energy converters	431

INSTRUCTIONS FOR THE APPLICATION OF THE TECHNICAL STANDARD	445
PART I GENERAL	447
ESI-I-1 COMPLETION OF THE INLAND NAVIGATION VESSEL CERTIFICATES.....	447
ESI-I-2 EXPERTS AND COMPETENT PERSONS.....	453
PART II PROVISIONS REGARDING SHIPBUILDING, FITTING OUT AND EQUIPMENT	455
ESI-II-1 MINIMUM HULL THICKNESS OF BARGES.....	455
ESI-II-2 INSTALLATION OF DOUBLER PLATES TO THE HULL.....	457
ESI-II-3 MINIMUM PRESCRIBED FORWARD SPEED, STOPPING CAPACITY AND CAPACITY FOR GOING ASTERN	459
ESI-II-4 CAPACITY FOR TAKING EVASIVE ACTION AND TURNING CAPACITY	483
ESI-II-5 NOISE MEASUREMENTS	489
ESI-II-6 APPROPRIATE AUXILIARY MEANS FOR OBSERVING THE AREA OF OBSTRUCTED VISION	499
ESI-II-7 USED OIL COLLECTION FACILITIES	505
ESI-II-8 (LEFT VOID).....	507
ESI-II-9 AUTHORISATION AND TEST PROCEDURE OF SPECIAL ANCHORS WITH REDUCED MASS	509
ESI-II-10 AUTOMATIC PRESSURISED WATER SPRINKLER SYSTEMS	513
ESI-II-11 STEERAGEWAY UNDER VESSEL'S OWN POWER	515
ESI-II-12 APPROPRIATE FIRE ALARM SYSTEM.....	517
ESI-II-13 MODEL FOR A LIMITED GENERAL PLAN OF THE ELECTRICAL INSTALLATION FOR CRAFT WHICH WERE LAID DOWN ON OR BEFORE 1 APRIL 1976.....	523
ESI-II-14 COLOUR CODING FOR FILLER NECKS	525
PART III SPECIAL PROVISIONS	527
ESI-III-1 APPLICATION OF CHAPTER 19 REQUIREMENTS	527
ESI-III-2 SPECIFIC SAFETY NEEDS OF PERSONS WITH REDUCED MOBILITY.....	529
ESI-III-3 STRENGTH OF WATERTIGHT WINDOWS	533
ESI-III-4 SAFETY GUIDANCE SYSTEM	535
ESI-III-5 SUITABLE GAS WARNING EQUIPMENT	539
ESI-III-6 COUPLING SYSTEMS AND COUPLING DEVICES FOR CRAFT SUITABLE FOR PROPELLING OR BEING PROPELLED IN A RIGID ASSEMBLY.....	543
ESI-III-7 FUEL TANKS ON FLOATING EQUIPMENT	547
ESI-III-8 RECREATIONAL CRAFT	549
ESI-III-9 PROOF OF BUOYANCY, TRIM AND STABILITY OF THE SEPARATED PARTS OF A VESSEL	551
ESI-III-10 EQUIPMENT FOR VESSELS TO BE OPERATED ACCORDING TO STANDARDS S1 OR S2	553
ESI-III-11 MATERIALS COMPLYING WITH THE EQUIVALENT REGULATIONS INSTEAD OF THE CODE FOR FIRE TEST PROCEDURES	557
ESI-III-12 ARRANGEMENTS OF METHANOL FUEL TANKS	561
PART IV TRANSITIONAL PROVISIONS	563
ESI-IV-1 APPLICATION OF TRANSITIONAL PROVISIONS	563

PART I GENERAL

CHAPTER 1 GENERAL

Article 1.01 Definitions

For the purposes of this Standard, the following definitions shall apply

1. Types of craft

- 1.1 'craft': a vessel or item of floating equipment;
- 1.2 'vessel': an inland waterway vessel or sea-going ship;
- 1.3 'inland waterway vessel': a vessel intended solely or mainly for navigation on inland waterways;
- 1.4 'sea-going ship': a vessel approved and intended primarily for sea-going or coastal navigation;
- 1.5 'motor tanker': a vessel intended for the carriage of goods in fixed tanks and built to navigate independently under its own motive power;
- 1.6 'motor cargo vessel': a vessel, other than a motor tanker, intended for the carriage of goods and built to navigate independently under its own motive power;
- 1.7 'canal barge': an inland waterway vessel not exceeding 38,5 m in length and 5,05 m in breadth;
- 1.8 'tug': a vessel specially built to perform towing operations;
- 1.9 'pusher': a vessel specially built to propel a pushed convoy;
- 1.10 'barge': a dumb barge or tank barge;
- 1.11 'tank barge': a vessel intended for the carriage of goods in fixed tanks and built to be towed, either having no motive power of its own or having only sufficient motive power to perform restricted manoeuvres;
- 1.12 'dumb barge': a vessel, other than a tank barge, intended for the carriage of goods and built to be towed, either having no motive power of its own or having only sufficient motive power to perform restricted manoeuvres;
- 1.13 'lighter': a tank lighter, cargo lighter or ship-borne lighter;

-
- 1.14 'tank lighter': a vessel intended for the carriage of goods in fixed tanks, built or specially modified to be pushed, either having no motive power of its own or having only sufficient motive power to perform restricted manoeuvres when not part of a pushed convoy;
- 1.15 'cargo lighter': a vessel, other than a tank lighter, intended for the carriage of goods and built or specially modified to be pushed, either having no motive power of its own or having only sufficient motive power to perform restricted manoeuvres when not part of a pushed convoy;
- 1.16 'ship-borne lighter': a lighter built to be carried aboard sea-going ships and to navigate on inland waterways;
- 1.17 'passenger vessel': a day trip or cabin vessel constructed and equipped to carry more than 12 passengers;
- 1.18 'passenger sailing vessel': a passenger vessel built and fitted out also with a view to propulsion under sail;
- 1.19 'day-trip vessel': a passenger vessel without overnight passenger cabins;
- 1.20 'cabin vessel': a passenger vessel with overnight passenger cabins;
- 1.21 'high-speed vessel': a motorised craft capable of reaching speeds over 40 km/h in relation to water;
- 1.22 'floating equipment': a floating installation carrying working gear such as cranes, dredging equipment, pile drivers or elevators;
- 1.23 'worksite craft': a vessel, appropriately built and equipped for use at worksites, such as a reclamation barge, hopper or pontoon barge, pontoon or stone-dumping vessel;
- 1.24 'recreational craft': a vessel other than a passenger vessel, intended for sport or pleasure;
- 1.25 'ship's boat': a boat for use in transport, rescue, salvage and work duties;
- 1.26 'floating establishment': any floating installation not normally intended to be moved, such as a swimming bath, dock, jetty or boathouse;
- 1.27 'floating object': a raft or other structure, object or assembly capable of navigation, not being a vessel or floating equipment or floating establishment;
- 1.28 'Traditional craft': a craft which, based on its age, its technical nature or construction, its rarity, its meaning for the preservation of traditional principles of seamanship or techniques of inland navigation or its significance for a period from a historic viewpoint, is worthy of being preserved, and is operated for demonstration purposes in particular, or a replica thereof;
- 1.29 'Replica of a traditional craft': a craft which was largely built from original materials, using an appropriate construction method according to plans or templates as a traditional craft;

2. Assemblies of craft

- 2.1 'convoy': a rigid or towed convoy of craft;
- 2.2 'formation': the manner in which a convoy is assembled;
- 2.3 'rigid convoy': a pushed convoy or side-by-side formation;
- 2.4 'pushed convoy': a rigid assembly of craft of which at least one is positioned in front of the craft providing the power for propelling the convoy, known as the 'pusher(s)'; a convoy composed of a pusher and a pushed craft coupled so as to permit guided articulation is also considered as rigid;
- 2.5 'side-by-side formation': an assembly of craft coupled rigidly side by side, none of which is positioned in front of the craft propelling the assembly;
- 2.6 'towed convoy': an assembly of one or more craft, floating establishments or floating objects towed by one or more self-propelled craft forming part of the convoy;

3. Particular areas on board

- 3.1 'main engine room': space where the propulsion engines are installed;
- 3.2 'engine room': space where combustion engines are installed;
- 3.3 'boiler room': a space housing a fuel-operated installation designed to produce steam or heat a thermal fluid;
- 3.4 'electrical service room' a room in which components of an electric propulsion system such as control cabinets or electric engines are located, and which is not an engine room;
- 3.5 'enclosed superstructure': a watertight, rigid, continuous structure with rigid walls joined to the deck in a permanent and watertight manner;
- 3.6 'wheelhouse': the area which houses all the control and monitoring instruments necessary for manoeuvring the vessel;
- 3.7 'accommodation': a space intended for the use of persons normally living on board, including galleys, toilets and washrooms, laundries, passageways, but not the wheelhouse;
- 3.8 'passenger room': rooms on board intended for passengers and enclosed areas such as lounges, offices, shops, hairdressing salons, drying rooms, laundries, saunas, toilets, washrooms, connecting corridors and stairs not encapsulated by walls;
- 3.9 'control centre': a wheelhouse, an area which contains an emergency electrical power plant or parts thereof or an area with a centre permanently occupied by shipboard personnel or crew members, such as for fire alarm system, remote controls of doors or fire dampers;
- 3.10 'stairwell': the well of an internal staircase or of a lift;

-
- 3.11 'lounge': a room of an accommodation or a passenger room. On board passenger vessels, galleys are not regarded as lounges;
- 3.12 'galley': a room with a stove or a similar cooking appliance;
- 3.13 'store room': a room for the storage of flammable liquids or a room with an area of over 4 m² for storing supplies;
- 3.14 'hold': part of the vessel, bounded fore and aft by bulkheads, opened or closed by means of hatch covers, intended for the carriage of goods, whether packaged or in bulk, or for housing tanks not forming part of the hull;
- 3.15 'fixed tank': a tank joined to the vessel, the walls of the tank consisting either of the hull itself or of a casing separate from the hull;
- 3.16 'work station': an area where members of the crew carry out their duties, including the gangway, derrick and ship's boat;
- 3.17 'passageway': an area intended for the normal movement of persons and goods;
- 3.18 'safe area': the area which is externally bounded by a vertical surface running at a distance of $1/5 B_{WL}$ parallel to the course of the hull in the line of maximum draught;
- 3.19 'muster areas': areas of the vessel which are specially protected and in which persons muster in the event of danger;
- 3.20 'evacuation areas': areas of the vessel from which evacuation of persons can be carried out;
- 3.21 'explosive atmosphere' a mixture with air, under atmospheric conditions, of flammable substances in the form of gas, vapour, dust, fibres, or flyings, which, after ignition, permits self-sustaining flame propagation;
- 3.22 'hazardous area' an area in which an explosive gas atmosphere is or may be expected to be present, in quantities such as to require special precautions for the construction, installation and use of equipment;
- 3.23 'zones' hazardous area classification based upon the frequency of the occurrence and duration of an explosive atmosphere;

'Zone 0': areas in which an explosive atmosphere is present continuously or for long periods or frequently.

'Zone 1': areas in which an explosive atmosphere is likely to occur in normal operation occasionally.

'Zone 2': areas in which an explosive atmosphere is not likely to occur in normal operation but, if it does occur, will persist for a short period only. These areas also include areas directly adjoining Zone 1 that are not separated from one another in a gas tight manner.

- 3.24 'certified safe type electrical equipment' an electrical equipment which has been tested and approved by the competent authority regarding its safety of operation in an explosive atmosphere;

4. Marine engineering terms

- 4.1 'plane of maximum draught': the water plane corresponding to the maximum draught at which the craft is authorised to navigate;
- 4.2 'safety clearance': the distance between the plane of maximum draught and the parallel plane passing through the lowest point above which the craft is no longer deemed to be watertight;
- 4.3 'residual safety clearance': the vertical clearance available, in the event of the vessel heeling over, between the water level and the lowest point of the immersed side, beyond which the vessel is no longer regarded as watertight;
- 4.4 'freeboard' or ' F ': the distance between the plane of maximum draught and a parallel plane passing through the lowest point of the gunwale or, in the absence of a gunwale, the lowest point of the upper edge of the ship's side;
- 4.5 'residual freeboard': the vertical clearance available, in the event of the vessel heeling over, between the water level and the upper surface of the deck at the lowest point of the immersed side or, if there is no deck, the lowest point of the upper surface of the fixed ship's side;
- 4.6 'margin line': an imaginary line drawn on the side plating not less than 10 cm below the bulkhead deck and not less than 10 cm below the lowest non-watertight point of the side plating. If there is no bulkhead deck, a line drawn not less than 10 cm below the lowest line up to which the outer plating is watertight shall be used;
- 4.7 'water displacement' or ' V ': the immersed volume of the vessel, in m^3 , in water with a density of 1000 kg/m^3 ;
- 4.8 'displacement' or ' Δ ': the total weight of the vessel, inclusive of cargo, in t;
- 4.9 'block coefficient' or ' C_B ': the ratio between the water displacement and the product of length L_{WL} , breadth B_{WL} and draught T ;
- 4.10 'lateral plane above water' or ' A_V ': lateral plane of the vessel above the waterline in m^2 ;
- 4.11 'bulkhead deck': the deck to which the required watertight bulkheads are taken and from which the freeboard is measured;
- 4.12 'bulkhead': a wall of a given height, usually vertical, partitioning the vessel and bounded by the bottom of the vessel, the plating or other bulkheads;
- 4.13 'transverse bulkhead': a bulkhead extending from one side of the vessel to the other;
- 4.14 'wall': a dividing surface, usually vertical;
- 4.15 'partition wall': a non-watertight wall;
- 4.16 'length' or ' L ': the maximum length of the hull in m, excluding rudder and bowsprit;

- 4.17 'length overall' or ' L_{OA} ': the maximum length of the craft in m, including all fixed installations such as parts of the steering system or power plant, mechanical or similar devices;
- 4.18 'length of waterline' or ' L_{WL} ': the length of the hull in m, measured at the maximum draught;
- 4.19 'breadth' or ' B ': the maximum breadth of the hull in m, measured to the outer edge of the shell plating (excluding paddle wheels, rub rails, and similar);
- 4.20 'breadth overall' or ' B_{OA} ': the maximum breadth of the craft in m, including all fixed equipment such as paddle wheels, rub rails, mechanical devices or similar;
- 4.21 'breadth of waterline' or ' B_{WL} ': breadth of the hull in m, measured from the outside of the side plating at the maximum draught line;
- 4.22 'height' or ' H ': the shortest vertical distance in m between the lowest point of the hull or the keel and the lowest point of the deck on the side of the vessel;
- 4.23 'draught' or ' T ': the vertical distance in m between the lowest point of the hull without taking into account the keel or other fixed attachments and the maximum draught line;
- 4.24 'draught overall' or ' T_{OA} ': the vertical distance in m between the lowest point of the hull including the keel or other fixed attachments and the maximum draught line;
- 4.25 'forward perpendicular': the vertical line at the forward point of the intersection of the hull with the maximum draught line;
- 4.26 'clear width of side deck': the distance between the vertical line passing through the most prominent part of the hatch coaming on the side deck side and the vertical line passing through the inside edge of the slip guard (guard-rail, foot rail) on the outer side of the side deck;
- 4.27 (left void);
- 4.28 "lightship waterline": the waterline corresponding to the lightship displacement;
- 4.29 "fixed height": the vertical distance in m between the lightship waterline of the craft and the highest point of the craft after all mobile installations (elevating wheelhouse, radar installations, foldable masts etc.) have been brought to their lowest positions;

5. Steering system

- 5.1 'steering system': all the equipment necessary for steering the vessel, such as to ensure the manoeuvrability laid down in Chapter 5;
- 5.2 'rudder': the rudder or rudders, with shaft, including the rudder quadrant and the components connecting with the steering apparatus;
- 5.3 'steering apparatus': the part of the steering system which produces the movement of the rudder;

-
- 5.4 'drive unit': the steering-apparatus drive, between the power source and the steering apparatus;
- 5.5 (left void);
- 5.6 'steering control': the component parts and the circuitry for the operation of a power-driven steering control;
- 5.7 'steering apparatus drive unit': the control for the steering apparatus, its drive unit and its power source;
- 5.8 'manual drive': a system whereby manual operation of the hand wheel moves the rudder by means of a mechanical transmission, without any additional power source;
- 5.9 'manually-operated hydraulic drive': a manual control actuating a hydraulic transmission;
- 5.10 'rate-of-turn regulator': equipment which automatically produces and maintains a given rate of turn of the vessel in accordance with preselected values;
- 5.11 'steering position designed for radar navigation by one person': a steering position arranged in such a way that, during radar navigation, the vessel can be manoeuvred by one person;
- 5.12 'Retractable wheelhouse': a wheelhouse whose height is adjusted solely by lowering the upper mobile part while the wheelhouse floor remains in position, or in another related manner;
- 5.13 'Elevating wheelhouse': a wheelhouse whose height is adjusted by the movement of the entire wheelhouse. This type of wheelhouse can additionally have a retractable upper part;

6. Properties of structural components and materials

- 6.1 'watertight': a structural component or device so fitted as to prevent any ingress of water;
- 6.2 'spray-proof and weathertight': a structural component or device so fitted that in normal conditions it allows only a negligible quantity of water to penetrate;
- 6.2a 'Unprotected opening' (or "open" type of opening): Openings which cannot be closed with at least weathertight means of closure should be considered as unprotected openings and, consequently, as down-flooding points. It also includes ventilation openings that have to remain open to supply air to the engine room or emergency generator room for the operation of the vessel;
- 6.3 'gastight': a structural component or device so fitted as to prevent the ingress of gas and vapours;
- 6.4 'non-combustible': a substance which neither burns nor produces flammable vapours in such quantities that they ignite spontaneously when heated to approximately 750 °C;

- 6.5 'flame-retardant': material which does not readily catch fire, or whose surface at least restricts the spread of flames pursuant to the test procedure referred to in Article 19.11(1)(c);
- 6.6 'self-extinguishing' the characteristic of a burning substance whereby it extinguishes itself of its own accord within a short period once the ignition source has been removed, i.e. does not continue to burn;
- 6.7 'fire-resistance': the property of structural components or devices as certified by the test procedure referred to in Article 19.11(1)(d);
- 6.8 'Code for Fire Test Procedures': the International Code for the Application of Fire Test Procedures (FTP code) adopted under Resolution MSC.307(88)¹ by the Maritime Safety Committee of the International Maritime Organization (IMO);
- 6.9 'fire-restricting': the property of structural components or devices as certified by the test procedure referred to in Article 19.11(1)(e);

7. Signal lights, navigation and information equipment

- 7.1 'signal lights': light from navigation lights to indicate vessels;
- 7.2 'light signals': light used to supplement optical or acoustic signals;
- 7.3 'navigational radar installation': an electronic navigational aid for detecting and displaying the surroundings and traffic;
- 7.4 (left void);
- 7.5 'Inland ECDIS equipment': equipment fitted aboard a vessel and used within the meaning of the current edition of ES-RIS, part I. It can be operated in two different modes: information mode and navigation mode;
- 7.6 'information mode': use of Inland ECDIS equipment for information purposes only without radar overlay;
- 7.7 'navigation mode': use of Inland ECDIS equipment with radar overlay for navigating a craft;
- 7.8 'Inland AIS equipment': equipment fitted aboard a vessel and used within the meaning of the current edition of ES-RIS, part II;
- 7.9 'ES-RIS': the European Standard for River Information Services (ES-RIS 2025/1)²;

8. Engines

(left void);

¹ MSC.307(88) adopted on 3 December 2010 - International Code for Application of Fire Test Procedures.

² CESNI Resolution 2024-II-XX dated XX October 2024.

9. On-board sewage treatment plants

(left void);

10. Classification societies, experts, and competent persons

10.1 'recognised classification society': a classification society that has been recognised in accordance with CCNR or EU procedures respectively.

10.2 'highest class': the highest class is allocated to a vessel where

- the hull, including the steering and manoeuvring apparatus as well as the anchors and anchor chains, comply with the rules established by a recognised classification society and has been built and tested under its supervision.
- the propulsion machinery as well as the auxiliary engines, the mechanical and electrical equipment, required for shipboard services, have been manufactured and tested in accordance with the classification society's rules and have been installed under its supervision; the unit as a whole will have successfully undergone post installation testing.

10.3 'expert': a person recognised by the competent authority or by an authorised institution, having specialist knowledge in the relevant area on the basis of his or her professional training and experience, fully conversant with the relevant rules and regulations and the generally accepted technical rules (e.g. EN Standards, relevant legislation, technical rules), and able to examine and give an expert assessment of the relevant systems and equipment;

10.4 'competent person': a person who has acquired sufficient knowledge in the relevant area on the basis of his or her professional training and experience and is sufficiently conversant with the relevant rules and regulations and the generally accepted technical rules (such as EN Standards, relevant legislation, technical rules) to be able to assess the operational safety of the relevant systems and equipment;

11. Electrical equipment, installations and electric propulsion

11.1 'power source' an energy carrier or energy converter used for producing useful energy. For rudder machinery propulsion systems the power supply to the steering drive unit and the steering apparatus (usually produced by an onboard network or a battery, alternatively an accumulator or an internal combustion engine);

11.2 'electrical power source' the power source from which electric power is obtained (usually an internal combustion engine with an energy converter e.g. a generator or a battery, or alternatively an accumulator);

11.3 'accumulator' a rechargeable storage device for electrical energy on an electro-chemical basis;

11.4 'battery' a non-rechargeable storage device for electrical energy on an electro-chemical basis;

11.5 'power electronics' an installation, appliance, assembly or device for converting electrical energy with switching electronic devices or a system comprised thereof;

12. Other terms

- 12.1 'shipboard personnel': all employees on board a passenger vessel who are not members of the crew;
- 12.2 'persons with reduced mobility': persons facing particular problems when using public transport, such as the elderly and the handicapped and persons with sensory disabilities, persons in wheelchairs, pregnant women and persons accompanying young children;
- 12.3 'ADN': the Regulations annexed to The European Agreement concerning the International Carriage of Dangerous Goods by Inland Waterways (ADN) in its current version;
- 12.4 'inland navigation vessel certificate': Union certificate for inland navigation vessels or Rhine vessel inspection certificate, issued by the competent authority and which confirms compliance with the technical requirements.

Article 1.02
Instructions for the application of this Standard

The instructions annexed to this Standard aim to facilitate and standardise its application.

**CHAPTER 2
PROCEDURE**

(left void)

PART II

PROVISIONS REGARDING SHIPBUILDING, FITTING OUT AND EQUIPMENT

CHAPTER 3

SHIPBUILDING REQUIREMENTS

Article 3.01

Basic rules

Vessels shall be built in accordance with good shipbuilding practice.

Article 3.02

Strength and stability

1. The hull shall be sufficiently strong to withstand all of the stresses to which it is normally subjected.
 - a) In the case of newly built vessels or major conversions affecting vessel strength, adequate strength shall be demonstrated by presenting the design calculation proof. That proof is not required where a classification certificate or an attestation from a recognised classification society is submitted.
 - b) In the event of periodical inspection, the minimum thickness of the bottom, bilge and side plates of vessels made from steel shall be no less than the higher of the values resulting from the following formulae:
 1. for vessels that are longer than 40 m: $t_{min} = f \cdot b \cdot c (2,3 + 0,04 L)[mm]$;
for vessels not more than 40 m in length: $t_{min} = f \cdot b \cdot c (1,5 + 0,06 L)[mm]$, however, not less than 3,00 mm.
 2. $t_{min} = 0,005 \cdot a \sqrt{T} [mm]$.

where:

 - a = frame spacing (mm);
 - f = frame spacing factor
 $f = 1$ for $a \leq 500$ mm,
 $f = 1 + 0,0013 (a - 500)$ for $a > 500$ mm;
 - b = factor for bottom, side or bilge plates
 $b = 1,0$ for bottom plates and side plates,
 $b = 1,25$ for bilge plates.

$f = 1$ may be taken for the frame spacing when calculating the minimum thickness of the side plates. However, the minimum thickness of the bilge plates may in no case be less than that of the bottom plates and side plates.

 - c = factor for the type of structure:
 - $c = 0,95$ for vessels with double bottom and double side with the hold's boundary located vertically in line with the coaming,
 - $c = 1,0$ for all other types of structure.

- c) In longitudinally framed vessels with double bottom and double side, the minimum value calculated for the plate thickness in accordance with the formulae in (b) may be reduced to a calculated value certified by a recognised classification society for sufficient hull strength (longitudinal, lateral and local strength).
- Plates shall be renewed if bottom, bilge or side plates are below the permissible value laid down in this way.
- The minimum values calculated in accordance with the method are limit values taking account of normal, uniform wear, and provided that shipbuilding steel is used and that the internal structural components such as frames, frame floor, main longitudinal and transverse structural members are in a good state and that the hull shows no indication of any overloading of the longitudinal strength.
- As soon as these values are no longer achieved, the plates in question shall be repaired or replaced. However, lesser thicknesses, of not more than 10 % reduction from calculated values, are acceptable locally for small areas.
2. Where a material other than steel is used for the construction of the hull, it shall be proved by calculation that the hull strength (longitudinal, lateral and local strength) equals at least the strength that would result from the use of steel under the assumption of minimum thickness in accordance with (1). If a certificate of class or a declaration issued by a recognised classification society is presented, a proof by calculation may be dispensed with.
3. The stability of vessels shall correspond to their intended use.

Article 3.03

Hull

1. Bulkheads rising up to the deck or, where there is no deck, up to the gunwale, shall be installed at the following points:
- a) A collision bulkhead at a suitable distance from the bow in such a way that the buoyancy of the laden vessel is ensured, with a residual safety clearance of 100 mm if water enters the watertight compartment ahead of the collision bulkhead.
- As a general rule, the requirement referred to in (1) shall be considered to have been met if the collision bulkhead has been installed at a distance of between $0,04 L$ and $0,04 L + 2 m$ measured from the forward perpendicular in the plane of maximum draught.
- If this distance exceeds $0,04 L + 2 m$, the requirement set out in (1) shall be proved by calculation.
- The distance may be reduced to $0,03 L$. In that case the requirement referred to in (1) shall be proved by calculation on the assumption that the compartment ahead of the collision bulkhead and those adjacent have all been filled with water.

- b) An aft-peak bulkhead at a suitable distance from the stern where the vessel length L exceeds 25 m in such a way that the buoyancy of the laden vessel is ensured, with a residual safety clearance of 100 mm if water enters the watertight compartment aft of the aft peak bulkhead.

As a general rule, the requirement referred to in the first subparagraph shall be considered to have been met if the aft peak bulkhead has been installed at a distance of between 1,4 m and $0,04 L + 2 m$ measured from the aft point of the intersection of the hull with the maximum draught line.

If this distance is greater than $0,04 L + 2 m$, the requirement referred to in the first subparagraph must be proved by calculation.

The distance may be decreased to 1 m. In this case, the requirement referred to in the first subparagraph must be substantiated by calculation on the assumption that the compartment aft of the aft peak bulkhead and the immediately adjacent compartments have been filled with water.

2. No accommodation or installations needed for safety of the vessel and its operation may be located ahead of the plane of the collision bulkhead or aft of the aft-peak bulkhead.

This requirement shall not apply to anchor gear

Furthermore, this requirement shall not apply to

- a) steering apparatus;
- b) rudder-propeller, water-jet, and cycloidal-propeller installations; or
- c) propulsion installations comparable to (b)

located aft of the aft-peak bulkhead. This also includes electric drives of these installations.

3. The accommodation, engine rooms and boiler rooms, and the workspaces forming part of these shall be separated from the holds by watertight transverse bulkheads that extend up to the deck.
4. The accommodation shall be separated from engine rooms, boiler rooms and holds in a gastight manner and shall be directly accessible from the deck. If no such access has been provided an emergency exit shall also lead directly to the deck.
5. The bulkheads specified in (1) and (3) and the separation of areas specified in (4) shall not contain any openings.

However, doors in the aft-peak bulkhead and penetrations, in particular for shafts and pipework, shall be permitted where they are so designed that the effectiveness of those bulkheads and of the separation of areas is not impaired. Doors in the aft-peak bulkhead shall be permitted only if it can be determined by remote monitoring in the wheelhouse whether they are open or closed and shall bear the following readily legible instruction on both sides:

‘Door to be closed immediately after use’.

6. The water inlets and discharges, and the pipework connected to these, shall be such that no unintentional ingress of water into the vessel is possible.
7. The fore-sections of vessels shall be built in such a way that the anchors neither wholly nor partly protrude beyond the side plating.

Article 3.04
Engine and boiler rooms, bunkers

1. Engine or boiler rooms shall be arranged in such a way that the equipment therein can be operated, serviced and maintained easily and safely.
2. The liquid-fuel or lubricant bunkers and passenger rooms and accommodation may not have any common surfaces which are under the static pressure of the liquid when in normal service.
3. Walls, ceilings and doors of engine rooms, boiler rooms and bunkers shall be made of steel or another equivalent non-combustible material.

Insulation material used in engine rooms shall be protected against the intrusion of fuel and fuel vapours.

All openings in walls, ceilings, and doors of engine rooms, boiler rooms, and bunker rooms shall be such that they can be closed from outside the room. The locking devices shall be made from steel or another equivalent non-combustible material.

4. Engine and boiler rooms and other premises in which flammable or toxic gases can escape shall be capable of being adequately ventilated.
5. Companionways and ladders providing access to engine and boiler rooms and bunkers shall be firmly attached and be made of steel or another equivalent shock-resistant and non-combustible material.
6. Engine and boiler rooms shall have two exits of which one may be an emergency exit.

The second exit may be dispensed with if:

- a) the total floor area (average length × average width at the level of the floor plating) of the engine or boiler room does not exceed 35 m²; and
 - b) the path between each point where servicing or maintenance operations are to be carried out and the exit, or foot of the companionway near the exit providing access to the outside, is not longer than 5 m; and
 - c) a fire extinguisher is located at the servicing point that is furthest removed from the exit door and also, by way of derogation from Article 13.03(1)(e), where the installed power of the engines does not exceed 100 kW.
7. The permissible sound pressure level in the engine rooms shall not exceed 110 dB(A). The measuring points shall be selected as a function of the maintenance work needed during normal operation of the plant located therein.

CHAPTER 4

SAFETY CLEARANCE, FREEBOARD AND DRAUGHT SCALES

Article 4.01

Safety clearance

1. The safety clearance shall be at least 300 mm.
2. The safety clearance in the case of vessels whose openings cannot be closed by spray-proof and weathertight devices, and for vessels sailing with their holds uncovered, shall be increased in such a way that each of those openings shall be at least 500 mm from the plane of maximum draught.
3. However, for safety reasons, the inspection body may lay down a greater value for the safety clearance.

Article 4.02

Freeboard

1. The freeboard of vessels with a continuous deck, without sheer and superstructures, shall be 150 mm.
2. The freeboard of vessels with sheer and superstructures shall be calculated using the following formula:

$$F = 150 (1 - \alpha) - \frac{\beta_v \cdot Se_v + \beta_a \cdot Se_a}{15} \text{ [mm]}$$

where:

- α is a correction coefficient that takes account of all of the superstructures involved;
- β_v is a coefficient for correcting the effect of the forward sheer resulting from the presence of superstructures in the forward quarter of length L of the vessel;
- β_a is a coefficient correcting the effect of the aft sheer resulting from the presence of superstructures in the aft quarter of length L of the vessel;
- Se_v is the effective forward sheer in mm;
- Se_a is the effective aft sheer in mm.

3. The coefficient α is calculated using the following formula:

$$\alpha = \frac{\sum le_a + \sum le_m + \sum le_v}{L}$$

where:

- le_m is the effective length, in m, of a superstructure located in the median part corresponding to half of length L of the vessel;
- le_v is the effective length, in m, of a superstructure in the forward quarter of vessel length L ;
- le_a is the effective length, in m, of a superstructure in the aft quarter of vessel length L .

The effective length of a superstructure is calculated using the following formulae:

$$le_m = l \cdot \left(2,5 \cdot \frac{b}{B} - 1,5 \right) \cdot \frac{h}{0,36} \text{ [m]}$$

$$le_v, \text{ resp. } le_a = l \cdot \left(2,5 \cdot \frac{b}{B_1} - 1,5 \right) \cdot \frac{h}{0,36} \text{ [m].}$$

where:

l is the effective length, in m, of the superstructure involved;

b is the width, in m, of the superstructure involved;

B_1 is the width of the vessel, in m, measured on the outside of the vertical sideplates at deck level halfway along the superstructure involved;

h is the height, in m, of the superstructure involved. However, in the case of hatches, h is obtained by reducing the height of the coamings by half of the safety distance according to Article 4.01. In no case will a value exceeding 0,36 m be taken for h .

If $\frac{b}{B}$ or $\frac{b}{B_1}$ is less than 0,6 the effective length le of the superstructure will be zero.

4. Coefficients β_v and β_a are calculated using the following formulae:

$$\beta_v = 1 - \frac{3 \cdot le_v}{L}$$

$$\beta_a = 1 - \frac{3 \cdot le_a}{L}$$

5. The effective aft/forward sheers Se_v/Se_a are calculated using the following formulae:

$$Se_v = S_v \cdot p$$

$$Se_a = S_a \cdot p$$

where:

S_v is the actual forward sheer, in mm; however S_v shall not be taken to be more than 1000 mm;

S_a is the actual aft sheer, in mm; however S_a may not be taken to be more than 500 mm;

p is a coefficient calculated using the following formula:

$$p = 4 \cdot \frac{x}{L}$$

x is the abscissa, measured from the extremity of the point where the sheer is 0,25 S_v or 0,25 S_a (see Figure 1).

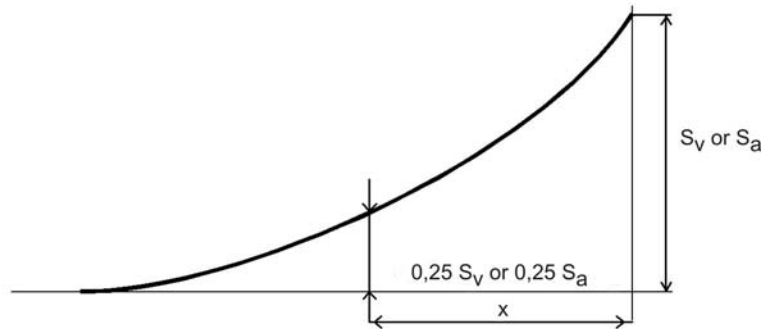

Figure 1

However, coefficient p will not be taken to be more than 1.

6. If $\beta_a \cdot Se_a$ is greater than $\beta_v \cdot Se_v$, the value of $\beta_v \cdot Se_v$ will be taken as being the value for $\beta_a \cdot Se_a$.
7. In view of the reductions referred to in (2) to (6) the freeboard shall be not less than 0 mm.
8. However, for safety reasons, the inspection body may lay down a greater value for the freeboard.
9. For vessels intended to operate in zones 1 and 2, the inspection body may take into account salinity when calculating freeboard.

Article 4.03 ***Draught marks***

1. Zone R is equivalent to Zone 3.
2. The plane of maximum draught for each permitted zone shall be determined in such a way that the specifications concerning freeboard, safety clearance and the vessel's maximum design draught are all met.
3. The plane of maximum draught shall be indicated by means of highly visible, indelible draught marks.
4. Draught marks are to be designed as follows:
 - a) The topmost draught mark points towards the stern and is a rectangle 300 mm long and 30 mm high, the baseline of which is horizontal and coincides with the plane of the deepest authorised draught. If the topmost draught mark is the one applicable to zone 3, it is 40 mm high.
 - b) The additional draught marks to be added point towards the bow and the following provisions apply:
 - aa) Draught marks for zone 3 comprise a rectangle 300 mm long and 40 mm high
 - bb) Draught marks for zones 1 and 2 comprise a rectangle 150 mm long and 30 mm high, the baseline of which is horizontal and coincides with the plane of the maximal permissible draught.
 - c) If the draught mark to be added for zone 3 or 4 coincides with the uppermost draught mark, the latter can be dispensed with.

5. The number of the zone, in characters 60 mm high x 40 mm deep, is to be added next to the draught marks towards the bow; in the case of zone 4, the number can be dispensed with.
6. The draught marks according to (4) and (5) and their orientation are to be in accordance with Figure 2.

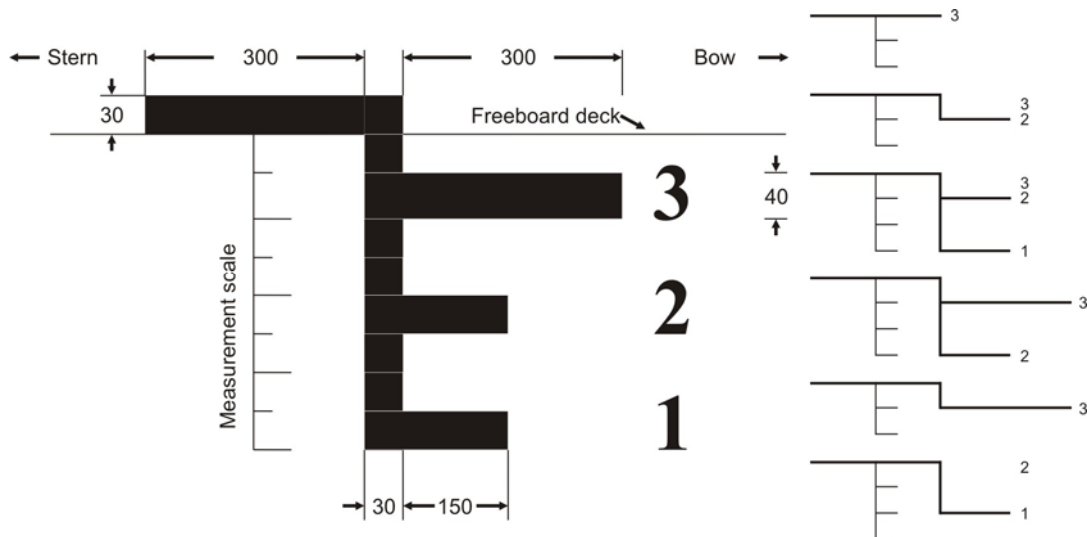

Figure 2

7. Vessels shall have at least three pairs of draught marks, of which one shall be at 1/2 of the length L and the two others located, respectively, at a distance from the bow and stern that is equal to 1/6 of the length L .
8. Marks or indications which cease to be valid following a further inspection shall be deleted or marked as being no longer valid under the supervision of the inspection body. Illegible draught marks may only be replaced under the supervision of an inspection body.
9. Where a vessel has been measured in implementation of the 1966 Convention on the Measurement of inland navigation vessels and the measurement mark is at the same height as the uppermost of the draught marks prescribed in (4), this measurement mark shall also be deemed to be the draught mark for this zone; this shall be mentioned in the inland navigation vessel certificate.
10. By way of derogation from (7)
 - a) where a vessel is less than 40 m in length L it will suffice to affix two pairs of draught marks at a distance from the bow and stern, respectively, that is equal to approximately a quarter of the length L ;
 - b) where vessels are not intended for the carriage of goods, a pair of draught marks located roughly halfway along the vessel will suffice.
11. If the plane of maximum draught of a vessel for one or more zones has been determined by assuming that the holds may be closed in such a way as to make them spray-proof and weathertight, and if the distance between the plane of maximum draught and the upper edge of the coamings is less than the permissible safety clearance for the zone in question, the maximum draught for sailing with uncovered holds shall be determined.

The following statement shall be entered on the inland navigation vessel certificate:

'Where the hold hatches are totally or partly uncovered the vessel may only be loaded up to ... mm below the draught marks for Zone'

12. In the case of vessels with open holds, in addition to the provisions of (7) the draught marks for the relevant zones are to be supplemented by a rectangle 75 mm long by 30 mm high, pointing aft, the base of which is horizontal and coinciding with the level of the maximum permissible draught for navigation in the zone in question with open holds.
13. The draught marks according to (12) and their orientation are to be in accordance with Figure 3.

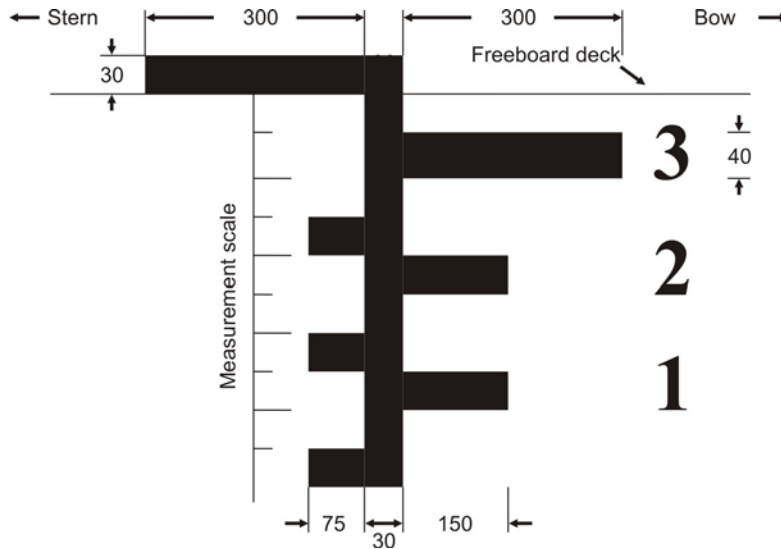

Figure 3

Article 4.04 *Draught scales*

1. Vessels whose draught may exceed 1 m shall bear a draught scale on each of their sides towards the stern; they may bear additional draught scales.
2. The zero points on each draught scale shall be taken vertically to this within the plane running parallel to the plane of maximum draught passing through the lowest point of the hull or of the keel where such exists. The vertical distance above the zero point shall be graduated in decimetres. That graduation shall be located on each scale, from the unladen water line up to 100 mm above the maximum draught by means of punched or chiselled marks, and shall be painted in the form of a highly-visible band in two alternating colours. That graduation shall be identified by figures at a distance of every five decimetres marked next to the scale as well as at the top of the scale.

3. The two stern measurement scales affixed pursuant to the 1966 Convention on the Measurement of inland navigation vessels may replace the draught scales, provided that they include a graduation that meets the requirements plus, where appropriate, figures indicating the draught.

Article 4.05

Specific requirements applicable to vessels navigating on zone 4 waterways

1. By way of derogation from Article 4.01 the safety clearance of doors and openings other than hold hatches for vessels navigating on Zone 4 waterways is reduced as follows:
 - a) for openings which can be closed spray-proof and weathertight, to 150 mm;
 - b) for openings which cannot be closed spray-proof and weathertight, to 200 mm.
2. By way of derogation from Article 4.02, the freeboard of vessels navigating on Zone 4 waterways may not be less than 0 mm, if the safety clearance according to (1) is respected.

CHAPTER 5

MANOEUVRABILITY

Article 5.01 **General**

1. Vessels and convoys shall display adequate navigability and manoeuvrability.
2. Unpowered vessels intended to be towed shall meet the specific requirements laid down by the inspection body.
3. Powered vessels and convoys shall meet the requirements set out in Articles 5.02 to 5.10.

Article 5.02 **Navigation tests**

1. Navigability and manoeuvrability shall be checked by means of navigation tests. Compliance with the requirements of Articles 5.06 to 5.10 shall, in particular, be examined.
2. The inspection body may dispense with all or part of the tests where compliance with the navigability and manoeuvrability requirements is proven in another manner.

Article 5.03 **Test area**

1. The navigation tests referred to in Article 5.02 shall be carried out on areas of inland waterways that have been designated by the competent authorities.
2. Those test areas shall be situated on a stretch of flowing or standing water that is if possible straight, at least 2 km long and sufficiently wide and is equipped with highly-distinctive marks for determining the position of the vessel.
3. It shall be possible for the inspection body to plot the hydrological data such as depth of water, width of fairway and average speed of the current in the navigation area as a function of the various water levels.

Article 5.04 ***Degree of loading of vessels and convoys during navigation tests***

During navigation tests, vessels and convoys intended to carry goods shall be loaded to at least 70 % of their tonnage and loading, distributed in such a way as to ensure a horizontal attitude as far as possible. If the tests are carried out with a lesser load the approval for downstream navigation shall be restricted to that loading.

Article 5.05
Use of on-board facilities for navigation test

1. During the navigation test, all of the equipment referred to in items 34 and 52 of the inland navigation vessel certificate which may be actuated from the steering position may be used, apart from anchors.
2. However, during the test involving turning into the current referred to in Article 5.10, bow anchors may be used.

Article 5.06
Prescribed (forward) speed

1. Vessels and convoys shall achieve a speed in relation to the water of at least 13 km/h. That condition is not mandatory where pushers are operating solo.
2. The inspection body may allow derogations to vessels and convoys operating solely in estuaries and ports.
3. The inspection body shall check if the unladen vessel is capable of exceeding a speed of 40 km/h in relation to water. If this can be confirmed, the following entry shall be entered in item 52 of the inland navigation vessel certificate:

‘The vessel is capable of exceeding a speed of 40 km/h in relation to water.’

Article 5.07
Stopping capacity

1. Vessels and convoys shall be able to stop facing downstream in good time while remaining adequately manoeuvrable.
2. Where vessels and convoys with a length L of not more than 86 m and with a breadth B of not more than 22,90 m the stopping capacity mentioned above may be replaced by turning capacity.
3. The stopping capacity shall be proved by means of stopping manoeuvres carried out within a test area as referred to in Article 5.03 and the turning capacity by turning manoeuvres in accordance with Article 5.10.

Article 5.08
Capacity for going astern

Where the stopping manoeuvre required by Article 5.07 is carried out in standing water it shall be followed by a navigation test while going astern.

Article 5.09
Capacity for taking evasive action

Vessels and convoys shall be able to take evasive action in good time. That capacity shall be proven by means of evasive manoeuvres carried out within a test area as referred to in Article 5.03.

Article 5.10
Turning capacity

Vessels and convoys with a length L of not more than 86 m or with a breadth B of not more than 22,90 m shall be able to turn in good time.

That turning capacity may be replaced by the stopping capacity referred to in Article 5.07.

The turning capacity shall be proven by means of turning manoeuvres against the current.

CHAPTER 6

STEERING SYSTEM

Article 6.01

General requirements

1. Vessels shall be fitted with a reliable steering system which provides at least the manoeuvrability required by Chapter 5.
2. Powered steering systems shall be designed in such a way that the rudder cannot change position unintentionally.
3. The steering system as a whole shall be designed for permanent lists of up to 15° and ambient temperatures from - 20 °C to + 50 °C.
4. The component parts of the steering system shall be rugged enough to always be able to withstand the stresses to which they may be subjected during normal operation. No external forces applied to the rudder shall impair the operating capacity of the steering apparatus and its drive unit.
5. The steering system shall incorporate a powered drive unit if so required by the forces needed to actuate the rudder.
6. A steering apparatus with powered drive unit shall be protected against overloads by means of a system that restricts the torque applied by the drive unit.
7. The penetrations for the rudder stocks shall be so designed as to prevent the spread of water-polluting lubricants.

Article 6.02

Steering apparatus drive unit

1. If the steering apparatus has a powered drive unit, a second independent drive unit or an additional manual drive shall be present. In case of failure or malfunction of the drive unit of the rudder system, the second independent drive unit or the manual drive has to be in operation within 5 seconds.
2. If the second drive unit or manual drive is not placed in service automatically, it shall be possible to do so immediately by means of a single operation by the helmsman that is both simple and quick.
3. The second drive unit or manual drive shall ensure the manoeuvrability required by Chapter 5 as well.

Article 6.03
Hydraulic steering apparatus drive unit

1. No other power consumers may be connected to the hydraulic steering apparatus drive unit.
2. Hydraulic tanks shall be equipped with a warning system that monitors a dropping of the oil level below the lowest content level needed for safe operation.
3. The dimensions, design and arrangement of the pipework shall as far as possible exclude mechanical damage or damage resulting from fire.
4. Hydraulic hoses are:
 - a) only permissible, if vibration absorption or freedom of movement of components makes their use inevitable;
 - b) to be designed for at least the maximum service pressure;
 - c) to be renewed at the latest every eight years.
5. Hydraulic cylinders, hydraulic pumps and hydraulic motors as well as electric motors shall be examined at the latest every eight years by a specialised firm and repaired if required.

Article 6.04
Power source

1. Steering systems fitted with two powered drive units shall have at least two power sources.
2. If the second power source for the powered steering apparatus is not constantly available while the vessel is under way, a buffer device carrying adequate capacity shall provide back-up during the period needed for start-up.
3. In the case of electrical power sources, no other power consumers may be supplied by the main power source for the steering system.

Article 6.05
Manual drive

1. The manual wheel shall not be driven by a powered drive unit.
2. Regardless of rudder position, a kick-back of the wheel shall be prevented when the manual drive is engaged automatically.

Article 6.06***Rudder-propeller, water-jet, cycloidal-propeller and bow-thruster systems***

1. Where the thrust vectoring of rudder-propeller, water-jet, cycloidal-propeller or bow thruster installations is remotely actuated by electric, hydraulic or pneumatic means, there shall be two steering controls, each independent of the other, between the steering position and the propeller- or thruster-installation which, *mutatis mutandis*, meet the requirements of Articles 6.01 to 6.05.

Such systems are not subject to this paragraph if they are not needed in order to achieve the manoeuvrability required by Chapter 5 or if they are only needed for the stopping test.

2. Where there are two or more rudder-propeller, water-jet or cycloidal-propeller installations that are independent of each other the second actuation system is not necessary if the vessel retains the manoeuvrability required by Chapter 5 if one of the systems fails.

Article 6.07***Indicators and monitoring devices***

The rudder position shall be clearly displayed at the steering position. If the rudder-position indicator is electric it shall have its own power supply.

Article 6.08***Rate-of-turn regulators***

1. Rate-of-turn regulators and their components shall meet the requirements laid down in Article 10.20.
2. The proper functioning of the rate-of-turn regulator shall be displayed at the steering position by means of a green indicating light.

Any lack of or unacceptable variations in the supply voltage and an unacceptable decrease in the speed of rotation of the gyroscope shall be monitored.

3. Where, in addition to the rate-of-turn regulator, there are other steering systems, it shall be possible to clearly distinguish at the steering position which of these systems has been activated. It shall be possible to shift from one system to another immediately. The rate-of-turn regulator shall not have any influence on the steering systems.
4. The electricity supply to the rate-of-turn regulator shall be independent of other power consumers.
5. The gyroscopes, detectors and rate-of-turn indicators used in the rate-of-turn regulators shall meet the minimum requirements of the minimum specifications and test conditions concerning rate-of-turn displays for inland waterways, as laid down in Section II of Annex 5.

Article 6.09
Testing

1. The correct installation of the steering system shall be inspected by an inspection body. For this purpose the inspection body can require the following documents:
 - a) description of the steering system;
 - b) drawings of and information on the steering apparatus drive units and the steering control;
 - c) information concerning the steering apparatus;
 - d) electrical wiring diagram;
 - e) description of the rate-of-turn regulator;
 - f) operating and maintenance instructions for the steering system.
2. Operation of the entire steering system shall be checked by means of a navigation test. If a rate-of-turn regulator is installed it shall be checked that a predetermined course can be reliably maintained and that bends can be negotiated safely.
3. Power-driven steering systems shall be inspected by a competent person:
 - a) before being put into service;
 - b) after a failure;
 - c) after any modification or repair;
 - d) regularly at least every three years.
4. The inspection has to cover at least:
 - a) a check of conformity with the approved drawings and at periodical inspections whether alterations in the steering system were made;
 - b) a functional test of the steering system for all operational possibilities;
 - c) a visual check and a tightness check of the hydraulic components, in particular valves, pipelines, hydraulic hoses, hydraulic cylinders, hydraulic pumps, and hydraulic strainers;
 - d) a visual check of the electrical components, in particular relays, electric motors and safety devices;
 - e) a check of the optical and acoustic control devices.
5. An inspection attestation, signed by the competent person, shall be issued, showing the date of inspection.

CHAPTER 7 WHEELHOUSE

Article 7.01 General

1. Wheelhouses shall be arranged in such a way that the helmsman may at all times perform his task while the vessel is under way.
2. Under normal operating conditions, sound pressure generated by the vessel and measured at the level of the helmsman's head at the steering position shall not exceed 70 dB(A).
3. Where a steering position has been designed for radar navigation by one person, the helmsman shall be able to accomplish his task while seated and all of the display or monitoring instruments and all of the controls needed for operation of the vessel shall be arranged in such a way that the helmsman may use them comfortably while the vessel is under way without leaving his position or losing sight of the radar screen.

Article 7.02 Unobstructed view

1. There shall be an adequately unobstructed view in all directions from the steering position.
2. The area of obstructed vision for the helmsman ahead of the vessel in an unladen state with half of its supplies but without ballast shall not exceed 250 m.

To further reduce any area of obstructed vision, only appropriate auxiliary means shall be used.

Auxiliary means for reducing the area of obstructed vision may not be taken into account during the inspection.

3. The helmsman's field of unobstructed vision at his normal position shall be at least 240° of the horizon. The field of unobstructed vision shall be at least 140° within the forward semicircle.

No window frame, post or superstructure shall lie within the helmsman's usual axis of vision.

Even in the case where a field of unobstructed vision of at least 240° of the horizon is provided, the inspection body may require other measures and in particular the installation of appropriate auxiliary means if no sufficiently unobstructed view is provided towards the rear.

The lower edge of the side windows must be located as low as possible and the upper edge of the side and rear windows must be located as high as possible.

In determining whether the requirements in this Article for visibility from the wheelhouse are met, the helmsman shall be assumed to have a height of eye of 1,65 m above the wheelhouse floor at the steering position.

4. The upper edge of the forward facing windows of the wheelhouse shall be high enough to allow a person at the steering position a clear forward view.

This requirement shall have been fulfilled when a person at the steering position with height of eye of 1,80 m have a clear forward view to at least 10° above the horizontal at eye-level height.

5. There shall in all weathers be appropriate means of providing a clear view through the front windows.
6. The glazing used in wheelhouses shall be made of safety glass and have a light transmission of at least 75 %.

To avoid reflections, the wheelhouse front windows must be glare-free or fitted so as to exclude reflections effectively.

The requirement of the second sentence shall have been fulfilled when the windows are inclined from the vertical plane at an angle of not less than 10° and not more than 25°.

Article 7.03

General requirements concerning control, indicating and monitoring equipment

1. Control equipment needed to operate the vessel shall be brought into its operating position easily. That position shall be unambiguously clear.
2. Monitoring instruments shall be easily legible. It shall be possible to dim their lighting down to their extinction. Light sources shall be neither intrusive nor impair the legibility of the monitoring instruments.
3. There shall be a system for testing the warning and indicating lights.
4. It shall be possible to clearly establish whether a system is in operation. If its functioning is indicated by means of an indicating light, this shall be green.
5. Any malfunctioning or failure of systems that require monitoring shall be indicated by means of red warning lights.
6. An audible warning shall sound at the same time that a red warning light lights up. Audible warnings may be given by a single, collective signal. The sound pressure level of that signal shall exceed the maximum sound pressure level of the ambient noise at the steering position by at least 3 dB(A).
7. The audible warning shall be capable of being switched off after a malfunction or failure has been acknowledged. Such shutdown shall not prevent the alarm signal from being triggered by other malfunctions. The red warning lights shall only go out when the malfunction has been corrected.
8. The monitoring and indicating devices shall be automatically switched to an alternative power source if their own power source fails.

Article 7.04***Specific requirements concerning control, indicating and monitoring equipment of main engines and steering systems***

1. It shall be possible to control and monitor the main engines and steering systems from the steering position. Main engines fitted with a clutch which can be actuated from the steering position, or driving a controllable pitch propeller which can be controlled from the steering position, need only to be capable of being started up and shut down from the engine room.
2. The control for each main engine shall take the form of a single lever which prescribes an arc within a vertical plane that is approximately parallel to the longitudinal axis of the vessel. Movement of that lever towards the bow of the vessel shall cause forward motion, whereas movement of the lever towards the stern shall cause the vessel to go astern. Clutch engagement and reversal of the direction of motion shall take place about the neutral position of that lever. The lever shall catch in the neutral position.
3. (left void)
4. The indicating, monitoring and alarm devices required by (10) and (11), shall be located at the steering position.
5. Vessels with steering positions designed for radar navigation by one person shall be steered by means of a lever. It shall be possible to move that lever easily by hand. The position of the lever in relation to the longitudinal axis of the vessel shall correspond precisely to the position of the rudder blades. It shall be possible to release hold of the lever in any given position without that of the rudder blades changing. The neutral position of the lever shall be clearly perceptible.
6. Where the vessel is fitted with bow rudders or special rudders, particularly for going astern, these shall be actuated in steering positions designed for radar navigation by one person by special levers which, *mutatis mutandis*, meet the requirements set out in (5).

That requirement shall also apply where, in convoys, the steering system fitted to craft other than those powering the convoy is used.

7. Where rate-of-turn regulators are used, it shall be possible for the rate-of-turn control to be released in any given position without altering the speed selected.

The control shall turn through a wide enough arc to guarantee adequately precise positioning. The neutral position shall be clearly perceptible from the other positions. It shall be possible to increase or decrease the level of illumination.

8. The remote-control equipment for the entire steering system shall be installed in a permanent manner and be arranged in such a way that the course selected is clearly visible. If the remote control equipment can be disengaged, it shall be equipped with an indicating device displaying the respective operational conditions 'in service' or 'out of service'. The disposition and manipulation of the controls shall be functional.

For systems that are subsidiary to the steering system, such as active bow thrusters, remote-control equipment not permanently installed shall be acceptable provided that such a subsidiary installation can be activated by means of an override at any time within the wheelhouse.

9. In the case of rudder-propeller, water-jet, cycloidal-propeller and bow-thruster systems, equivalent devices shall be acceptable as control, indicating and monitoring devices.

The requirements set out in (1) to (8) shall apply, *mutatis mutandis*, in view of the specific characteristics and arrangements selected for the abovementioned active steering and propulsion units. In analogy to (2), each unit shall be controlled by a lever which moves in the form of an arc within a vertical plane that is approximately parallel to the direction of the thrust of the unit. From the position of the lever the direction of the thrust acting on the vessel shall be clear

If rudder propeller or cycloidal-propeller systems are not controlled by means of levers, the inspection body may allow derogations from (2). These derogations shall be entered in item 52 of the inland navigation vessel certificate.

10. At least the following parameters shall be monitored at the steering position by suitable devices, where relevant for the corresponding propulsion system:
- a) the characteristic operational temperature of the propulsion engines (e.g. temperature of the coolant of combustion engines or externally cooled electric engines, temperature of windings or bearings of electric engines);
 - b) the lubricating-oil pressure for the propulsion engines and transmissions;
 - c) the oil and air pressure of the reversing units of the propulsion engines, reversible transmissions or propellers;
 - d) the rotational speed of the propulsion engines;
 - e) the rotational speed of the propulsors;
 - f) the direction of thrust imparted to the vessel by the propulsors;
 - g) the level of available fuel in fuel tanks (filling level) or energy in accumulator sets (state of charge) supplying propulsion engines.
11. An acoustic and optical alarm pursuant to Article 7.03(5) to (7) shall be triggered at the steering position once a critical level has been reached or a failure has been detected. An alarm shall be triggered at least for the following parameters or functions, where relevant for the corresponding propulsion system:
- a) the characteristic operational temperature or a failure of the cooling system of the propulsion engines and ancillary installations essential for the operation of the propulsion engines (e.g. power electronics);
 - b) the lubricating-oil pressure for the propulsion engines and transmissions;
 - c) the oil and air pressure of the reversing units of the propulsion engines, reversible transmissions and propellers;
 - d) the rotational speed of the propulsion engines;
 - e) the level of available fuel in fuel tanks (filling level) or energy in accumulator sets (state of charge) supplying propulsion engines;
 - f) oil level of the hydraulic tanks falling under the lowest content level in accordance with Article 6.03(2) and decrease of service pressure of the hydraulic system;

- g) failure of the electrical supply for the steering control;
- h) failure of the electrical supply for the electric propulsion system;
- i) failure of the rate-of-turn regulator;
- j) failure of the required buffer devices;
- k) imminent activation of an overload protection in accordance with Article 11.04(2);
- l) activation of protective devices in accordance with Article 11.07; and
- m) power limitation in accordance with Article 11.06.

A critical level for (a) and (e) shall be corresponding to the capability of the vessel for making steerageway under its own power for at least 30 minutes.

Article 7.05 ***Navigation lights, light signals and sound signals***

1. Navigation lights, their casings and accessories shall bear the approval mark prescribed by Directive 2014/90/EU¹, as amended.
2. Current indicating lights or other equivalent devices, such as repeater lights, for monitoring the navigation lights shall be installed in the wheelhouse unless that monitoring can be performed direct from the wheelhouse.
3. In steering positions designed for radar navigation by one person, repeater lights shall be installed on the control panel in order to monitor the navigation lights and the light signals. Switches of navigation lights shall be included in the repeater lights or be adjacent to these and shall be clearly assigned to them.

The arrangement and colour of the repeater lights for the navigation lights and light signals shall correspond to the actual position and colour of those lights and signals.

The failure of a navigation light or light signal to function shall cause the corresponding repeater light either to go out or to provide a signal in another manner.

4. In steering positions designed for radar navigation by one person it shall be possible to activate the sound signals by a foot operated switch. That requirement shall not apply to the 'do not approach' signal in accordance with the applicable navigational authority regulations of the Member States.

¹ Directive 2014/90/EU of the European Parliament and of the Council of 23 July 2014 on marine equipment and repealing Directive 96/98/EC (OJ L 257, 28.8.2014).

Article 7.06

Navigation and information equipment

1. Navigational radar installation and rate-of-turn indicators shall fulfil the requirements laid down in Annex 5. Compliance with these requirements shall be determined by a type-approval issued by the competent authority.
2. Inland ECDIS equipment which can be operated in navigation mode shall be regarded as navigational radar installation. It shall meet the requirements of ES-RIS, parts I and V. The requirements of Annex 5 must be complied with.
3. Inland AIS equipment shall meet the requirements of ES-RIS, parts II and VI. The requirements of Annex 5 must be complied with.
4. The rate-of-turn indicator shall be located ahead of the helmsman and within his field of vision.
5. In steering positions designed for radar navigation by one person:
 - a) the radar screen shall not be shifted significantly out of the helmsman's axis of view in its normal position;
 - b) the radar image shall continue to be perfectly visible, without a mask or screen, whatever the lighting conditions outside the wheelhouse;
 - c) the rate-of-turn indicator shall be installed directly above or below the radar image or be incorporated into this.

Article 7.07

Radio telephony systems for vessels with steering positions designed for radar navigation by one person

1. Where vessel steering positions have been designed for radar navigation by one person, reception from the vessel to vessel networks and that of nautical information shall be via a loudspeaker, and outgoing communications via a fixed microphone. Send/receive shall be selected by means of a push-button.

It shall not be possible to use the microphones of those networks for the public correspondence network.
2. Where vessel steering positions designed for radar navigation by one person are equipped with a radio telephone system for the public correspondence network, reception shall be possible from the helmsman's seat.

Article 7.08

Internal communication facilities on board

There shall be internal communication facilities on board vessels with a steering position designed for radar navigation by one person.

It shall be possible to establish communication links from the steering position:

- a) with the bow of the vessel or convoy;
- b) with the stern of the vessel or convoy if no direct communication is possible from the steering position;
- c) with the crew accommodation;
- d) with the boatmaster's cabin.

Reception at all positions of these internal communication links shall be via loudspeaker, and transmission shall be via a fixed microphone. The link with the bow and stern of the vessel or convoy may be of the radio-telephone type.

Article 7.09 ***Alarm system***

1. There shall be an independent alarm system enabling the accommodation, engine rooms and, where appropriate, the separate pump rooms to be reached.
2. The helmsman shall have within reach an on/off switch controlling the alarm signal; switches which automatically return to the off position when released are not acceptable.
3. The sound pressure level for the alarm signal shall be at least 75 dB(A) within the accommodation area.

In engine rooms and pump rooms the alarm signal shall take the form of a flashing light that is visible on all sides and clearly perceptible at all points.

Article 7.10 ***Heating and ventilation***

Wheelhouses shall be equipped with an effective heating and ventilation system that can be regulated.

Article 7.11 ***Stern-anchor operating equipment***

On board vessels and convoys whose steering position has been designed for radar navigation by one person and exceeding 86 m in length or 22,90 m in breadth it shall be possible for the helmsman to drop the stern anchors from his position.

Article 7.12 ***Elevating wheelhouses***

1. A mechanically powered elevating wheelhouse and its appliances shall be designed in such a way that the safety of persons on board is not endangered.
2. An elevating wheelhouse shall not endanger the stability of the vessel.
3. The strength of the elevating wheelhouse, of the lifting mechanism and the associated vessel parts must be adequately dimensioned in accordance with good shipbuilding practice.
4. Operations carried out from the wheelhouse shall not be hindered during lifting and lowering. It shall be possible to enter and leave the wheelhouse, whatever its position. A roof opening may be used as an emergency exit, provided that it complies with the dimensions in Article 14.06(2).

5. It shall be possible to operate the lifting mechanism from inside the wheelhouse. The following indications shall be arranged at the steering position:
 - a) voltage present,
 - b) wheelhouse in lowest position,
 - c) wheelhouse in highest position,
 - d) wheelhouse locked in fixed position (if applicable).
6. The lifting mechanism shall enable the wheelhouse to stop in all positions. If the possibility exists to lock the wheelhouse in a certain position, the lifting mechanism shall be automatically disabled when locking takes place. Releasing the locks shall be possible under all operating conditions.
7. The lifting mechanism shall be designed in such a way that exceeding the terminal positions is not possible.
8. Arrangements shall be provided to avoid uncontrolled lowering of the wheelhouse. Appropriate protection features shall be installed to prevent the risk of injury which may result from lowering. Accesses to the lifting device shall be marked with the symbol shown in Annex 4, Figure 1, and equipped with a warning device that triggers an optical and acoustic warning signal in the wheelhouse. All lowering operations shall automatically trigger an optical and a clearly audible acoustic warning signal.
9. Elevating wheelhouses shall be fitted with an emergency lowering system, which is independent from the normal lifting mechanism and can be used even in the event of a failure of the energy supply. This emergency system shall be operated from inside the wheelhouse. When using the emergency system the lowering speed shall not be less than the lowering speed under normal conditions.
10. (left void)
11. Hydraulic hoses are:
 - a) only permissible, if vibration absorption or freedom of movement of components makes their use inevitable;
 - b) to be designed for at least the maximum service pressure;
 - c) to be renewed at the latest every eight years.
12. Elevating wheelhouses and their appliances shall be inspected regularly, but at least once every twelve months, by a competent person. The safety of the installation is to be established by a visual check and a check on satisfactory operation.

Article 7.13

Entry in the inland navigation vessel certificate for vessels with steering positions designed for radar navigation by one person

Where a vessel complies with the special provisions for steering positions designed for radar navigation by one person as set out in Articles 7.01(3), 7.04(5) and (6), 7.05(3) and (4), 7.06(2), 7.07, 7.08 and 7.11, the following entry shall be made in the inland navigation vessel certificate:

'The vessel has a steering position designed for radar navigation by one person'.

Article 7.14 Retractable wheelhouses

1. This article does not apply to:
 - a) dismountable wheelhouses, and
 - b) wheelhouses which do not make use of a mechanism (e.g. chains, pulleys, cables, etc.), whether they are moved by human, electric, hydraulic or pneumatic force.
2. A retractable wheelhouse and its appliances shall be designed in such a way that the safety of persons on board is not endangered.
3. Operations carried out from the wheelhouse shall not be hindered during lifting and lowering. It shall be possible to enter and leave the wheelhouse safely, whatever its position. The emergency exit may be an opening in the roof, provided that it complies with the dimensions in Article 14.06(2).
4. The lifting mechanism shall enable the wheelhouse to stop in all positions. If the possibility exists to lock the wheelhouse in a certain position, the lifting mechanism shall be automatically disabled when locking takes place. Releasing the locks shall be possible under all operating conditions.
5. The lifting mechanism shall be designed in such a way that exceeding the terminal positions is not possible.
6. Arrangements shall be provided to avoid uncontrolled lowering of the retractable wheelhouse. Appropriate protection features shall be installed to prevent the risk of injury which may result from lowering.

When deemed necessary, the inspection body may require the triggering of an optical or acoustic warning signal during lowering operations.
7. Hydraulic hoses are
 - a) only permissible, if vibration absorption or freedom of movement of components makes their use inevitable;
 - b) to be designed for at least the maximum service pressure;
 - c) to be renewed at the latest every eight years.
8. Retractable wheelhouses and their appliances shall be inspected regularly, but at least once every twelve months, by a competent person. The safety of the installation is to be established by a visual check and a check on satisfactory operation.

CHAPTER 8 ENGINE DESIGN

Article 8.01 General

1. Engines and their ancillaries shall be designed, built and installed in accordance with best practice.
2. Pressure vessels dedicated for the operation of the vessel shall be checked by an expert to verify that they are safe for operation:
 - a) before being put into service for the first time;
 - b) before being put back into service after any modification or repair; and
 - c) regularly, at least every five years.

The inspection shall involve an internal and an external inspection. Compressed-air vessels the interior of which cannot be properly inspected, or the condition of which cannot be clearly established during the internal inspection, are required to undergo additional non-destructive testing or a hydraulic pressure test.

An inspection attestation shall be issued, signed by the expert and showing the date of the inspection.

Other installations requiring regular inspection, particularly steam boilers, other pressure vessels and their accessories, and lifts, shall meet the regulations applying in one of the Member States.

3. Only internal-combustion engines burning fuels having a flashpoint of more than 55 °C may be installed.
4. By way of derogation from (3), craft may be equipped with propulsion or auxiliary systems operating on the following fuels with a flashpoint equal to or lower than 55 °C:
 - a) liquefied natural gas (LNG),
 - b) methanol and
 - c) gaseous hydrogen.

For propulsion or auxiliary systems operating these fuels the requirements of Chapter 30 and Annex 8 of this Standard shall apply.

Article 8.02 Safety equipment

1. Engines shall be installed and fitted in such a way as to be adequately accessible for operation and maintenance and shall not endanger the persons assigned to those tasks. It shall be possible to make them secure against unintentional starting.
2. Main engines, auxiliaries, boilers and pressure vessels, and their accessories, shall be fitted with safety devices.
3. In case of emergency, it shall also be possible to shut down the motors driving the blower and suction fans from outside the space in which they are located, and from outside the engine room.

4. Where necessary, connections of pipes which carry fuel oil, lubricating oil, and oils used in power transmission systems, control and activating systems and heating systems shall be screened or otherwise suitably protected to avoid oil spray or leakages onto hot surfaces, into machinery air intakes, or other sources of ignition. The number of connections in such piping systems shall be kept to a minimum.
5. External high pressure fuel delivery pipes of diesel engines, between the high pressure fuel pumps and fuel injectors, shall be protected with a jacketed piping system capable of containing fuel from a high pressure pipe failure. The jacketed piping system shall include a means for collection of leakages and arrangements shall be provided for an alarm to be given of a fuel pipe failure, except that an alarm is not required for engines with no more than two cylinders. Jacketed piping systems need not be applied to engines on open decks operating windlasses and capstans.
6. Insulation of engine parts shall meet the requirements of Article 3.04(3), second subparagraph.

Article 8.03 ***Propulsion systems***

1. It shall be possible to start, stop or reverse the ship's propulsion reliably and quickly.
2. Where vessels have only one propulsion engine, that engine shall not be shut down automatically except in order to protect against overspeed.
3. Where vessels have only one propulsion engine, that engine may be equipped with an automatic device for the reduction of the engine speed only if an automatic reduction of the engine speed is indicated both optically and acoustically in the wheelhouse and the device for the reduction of the engine speed can be switched off from the steering position.
4. Shaft bushings shall be designed in such a way as to prevent the spread of water-polluting lubricants.

Article 8.04 ***Engine exhaust system***

1. The exhaust gases shall be completely ducted out of the vessel.
2. All suitable measures shall be taken to avoid ingress of the exhaust gases into the various compartments. Exhaust pipes passing through accommodation or the wheelhouse shall, within these, be covered by protective gas-tight sheathing. The gap between the exhaust pipe and this sheathing shall be open to the outside air.
3. The exhaust pipes shall be arranged and protected in such a way that they cannot cause a fire.
4. The exhaust pipes shall be suitably insulated or cooled in the engine rooms. Protection against physical contact may suffice outside the engine rooms.

Article 8.05

Fuel tanks, pipes and accessories

1. Liquid fuels shall be stored in steel tanks which are either an integral part of the hull or which are firmly attached to the hull. If so required by the design of the vessel, an equivalent material in terms of fire-resistance may be used. These requirements shall not apply to tanks having a capacity of no more than 12 litres that have been incorporated in auxiliaries during their manufacture. Fuel tanks shall not have common partitions with drinking-water tanks.
2. Fuel tanks and their pipework and other accessories shall be laid out and arranged in such a way that neither fuel nor fuel vapours may accidentally reach the inside of the vessel. Tank valves intended for fuel sampling or water drainage shall close automatically.
3. No fuel tanks may be located forward of the collision bulkhead or aft of the aft-peak bulkhead.
4. Fuel tanks and their fittings shall not be located directly above engines or exhaust pipes.
5. The filler orifices for fuel tanks shall be marked distinctly and the filler necks shall be suitably labelled in colour. This requirement is deemed to be fulfilled if the requirements of the international standard ISO 14726 : 2008 are met.
6. The orifice for the fuel tank filler necks shall be on the deck, except for the daily-supply tanks. The filler neck shall be fitted with a connection piece in accordance with European Standard EN 12827 : 1999.

Such tanks shall be fitted with a breather pipe terminating in the open air above the deck and arranged in such a way that no water ingress is possible. The cross-section of the breather pipe shall be at least 1,25 times the cross-section of the filler neck.

If tanks are interconnected, the cross-section of the connecting pipe shall be at least 1,25 times the cross-section of the filler neck.

7. Directly at tank outlets the pipework for the distribution of fuels shall be fitted with a quick-closing valve that can be operated from the deck, even when the spaces in question are closed.

If the operating device is concealed, the lid or cover shall not be lockable.

The operating device shall be marked in red. If the device is concealed it shall be marked with a symbol for the 'quick-closing valve on the tank' in accordance with Figure 9 of Annex 4 with a side length of at least 10 cm.

The first subparagraph shall not apply to fuel tanks mounted directly on the engine.

8. Fuel pipes, their connections, seals and fittings shall be made of materials that are able to withstand the mechanical, chemical and thermal stresses to which they are likely to be subjected. The fuel pipes shall not be subjected to any adverse influence of heat and it shall be possible to inspect them throughout their length.

9. Fuel tanks shall be provided with a suitable capacity-gauging device. Capacity-gauging devices shall be legible right up to the maximum filling level. Glass gauges shall be effectively protected against impacts, shall be fitted with an automatic closing device at their base and their upper end shall be connected to the tanks above their maximum filling level. The material used for glass gauges shall not deform under normal ambient temperatures. Sounding pipes shall not terminate in accommodation spaces. Sounding pipes terminating in an engine or boiler room shall be fitted with suitable self-closing devices.
10.
 - a) Fuel tanks shall be safeguarded against fuel spills during bunkering by means of appropriate onboard technical devices which shall be entered in item 52 of the inland navigation vessel certificate.
 - b) If fuel is taken on from bunkering stations with their own technical devices to prevent fuel spills on board during bunkering, the equipment requirements in (a) and (11) shall no longer apply.
11. If fuel tanks are fitted with an automatic shut-off device, the sensors shall stop fuelling when the tank is 97 % full; this equipment shall meet the 'failsafe' requirements.

If the sensor activates an electrical contact, which can break the circuit provided by the bunkering station by a binary signal, it shall be possible to transmit the signal to the bunkering station by means of a watertight connection plug meeting the requirements of International Standard IEC 60309-1 : 2021 for 40 to 50 V DC, housing colour white, earthing contact position ten o'clock.
12. Fuel tanks shall be provided with openings having leak-proof closures that are intended to permit cleaning and inspection.

Article 8.06
Storage of lubricating oil, pipes and accessories

1. Lubricating oil shall be stored in steel tanks which are either an integral part of the hull or which are firmly attached to the hull. If so required by the design of the vessel, an equivalent material in terms of fire-resistance may be used. These requirements shall not apply to tanks having a capacity of no more than 25 litres. Lubricating oil tanks shall not have common partitions with drinking-water tanks.
2. Lubricating oil tanks and their pipework and other accessories shall be laid out and arranged in such a way that neither lubricating oil nor lubricating oil vapour may accidentally reach the inside of the vessel.
3. No lubricating oil tanks may be located forward of the collision bulkhead.
4. Lubricating oil tanks and their fittings shall not be located directly above engines or exhaust pipes.

5. The filler neck shall be fitted with a connection piece in accordance with the European standard EN 14420-7 : 2022. The male side of the connection piece shall be placed on the vessel and have a diameter DN 40. A blind coupling in accordance with the standard must be available for closing.
6. The filler orifices for lubricating oil tanks shall be marked distinctly and the filler necks shall be suitably labelled in colour. This requirement is deemed to be fulfilled if the requirements of the international standard ISO 14726 : 2008 are met.
7. Lubricating oil pipes, their connections, seals and fittings shall be made of materials that are able to withstand the mechanical, chemical and thermal stresses to which they are likely to be subjected. The pipes shall not be subjected to any adverse influence of heat and it shall be possible to inspect them throughout their length.
8. Lubricating oil tanks shall be provided with a suitable capacity-gauging device. Capacity-gauging devices shall be legible right up to the maximum filling level. Glass gauges shall be effectively protected against impacts, shall be fitted with an automatic closing device at their base and their upper end shall be connected to the tanks above their maximum filling level. The material used for glass gauges shall not deform under normal ambient temperatures. Sounding pipes shall not terminate in accommodation spaces. Sounding pipes terminating in an engine or boiler room shall be fitted with suitable self-closing devices.

Article 8.07

Storage of oils used in power transmission systems, control and activating systems and heating systems, pipes and accessories

1. Oils used in power transmission systems, control and activating systems and heating systems shall be stored in steel tanks which are either an integral part of the hull or which are firmly attached to the hull. If so required by the design of the vessel, an equivalent material in terms of fire-resistance may be used. These requirements shall not apply to tanks having a capacity of no more than 25 litres. Oil tanks according to sentence (1) shall not have common partitions with drinking-water tanks.
2. Oil tanks according to (1) and their pipework and other accessories shall be laid out and arranged in such a way that neither such oil nor such oil vapour may accidentally reach the inside of the vessel.
3. No oil tanks according to (1) may be located forward of the collision bulkhead.
4. Oil tanks according to (1) and their fittings shall not be located directly above engines or exhaust pipes.
5. The filler orifices for oil tanks according to (1) shall be marked distinctly and the filler necks shall be suitably labelled in colour. This requirement is deemed to be fulfilled if the requirements of the international standard ISO 14726 : 2008 are met.

6. Oil pipes according to (1), their connections, seals and fittings shall be made of materials that are able to withstand the mechanical, chemical and thermal stresses to which they are likely to be subjected. The pipes shall not be subjected to any adverse influence of heat and it shall be possible to inspect them throughout their length.
7. Oil tanks according to (1) shall be provided with a suitable capacity-gauging device. Capacity-gauging devices shall be legible right up to the maximum filling level. Glass gauges shall be effectively protected against impacts, shall be fitted with an automatic closing device at their base and their upper end shall be connected to the tanks above their maximum filling level. The material used for glass gauges shall not deform under normal ambient temperatures. Sounding pipes shall not terminate in accommodation spaces. Sounding pipes terminating in an engine or boiler room shall be fitted with suitable self-closing devices.

Article 8.08 ***Bilge pumping and drainage systems***

1. It shall be possible to pump out each watertight compartment separately. However, that requirement shall not apply to watertight compartments that are normally sealed hermetically during operation.
2. Vessels requiring a crew shall be equipped with two independent bilge pumps which shall not be installed within the same space. At least one of these shall be motor driven. However, for vessels with a power of less than 225 kW or with a deadweight of less than 350 t, or where vessels not intended for the carriage of goods have a displacement of less than 250 m³, one pump will suffice which can be either manually-operated or motor-driven.

Each of the required pumps shall be capable of use in each watertight compartment.

3. The minimum pumping capacity Q_1 of the first bilge pump shall be calculated using the following formula:

$$Q_1 = 0,1 \cdot d_1^2 \text{ [l/min]}$$

d_1 is calculated via the formula:

$$d_1 = 1,5 \cdot \sqrt{L(B + H)} + 25 \text{ [mm]}$$

The minimum pumping capacity Q_2 of the second bilge pump shall be calculated using the following formula:

$$Q_2 = 0,1 \cdot d_2^2 \text{ [l/min]}$$

d_2 is calculated using the formula:

$$d_2 = 2 \cdot \sqrt{l(B + H)} + 25 \text{ [mm]}$$

However, the value d_2 need not exceed value d_1 .

For the calculation of Q_2 l shall be taken to be the length of the longest watertight compartment.

In these formulae:

l is the length of the watertight compartment in question, in [m];

d_1 is the calculated internal diameter of the main drainage pipe, in [mm];

d_2 is the calculated internal diameter of the branch pipe, in [mm].

4. Where the bilge pumps are connected to a drainage system the drainage pipes shall have an internal diameter of at least d_1 , in mm, and the branch pipes an internal diameter of at least d_2 , in mm.

Where the vessels length L is less than 25 m the values d_1 and d_2 may be reduced to 35 mm.

5. Only self-priming bilge pumps are permitted.
6. There shall be at least one suction on both the starboard and port sides of all flat-bottomed, drainable compartments that are wider than 5 m.
7. It may be possible to drain the aft peak via the main engine room by means of an easily accessible, automatically closable fitting.
8. Branch pipes of single compartments shall be connected to the main drainage pipe by means of a lockable non-return valve.

Compartments or other spaces that are capable of carrying ballast need to be connected to the drainage system only by means of a simple closing device. That requirement shall not apply to holds that are capable of carrying ballast. Such holds shall be filled with ballast water by means of ballast piping that is permanently installed and independent of the drainage pipes, or by means of branch pipes that can be connected to the main drainage pipe by flexible pipes or flexible adaptors. Water intake valves located in the bottom of the hold shall not be permitted for this purpose.

9. Hold bilges shall be fitted with gauging devices.
10. Where a drainage system incorporates permanently installed pipework the bilge-bottom drainage pipes intended to extract oily water shall be equipped with closures that have been sealed in position by an inspection body. The number and position of those closures shall be entered on the inland navigation vessel certificate.
11. Locking the closures in position shall be regarded as equivalent to sealing in accordance with (10). The key or keys for the locking of the closures shall be indicated accordingly and kept in a marked and easily accessible location in the engine room.

Article 8.09 ***Oily water and used oil stores***

1. It shall be possible to store, on board, oily water accumulated during operation. The engine room bilge is considered to be a store for this purpose.
2. In order to store used oils there shall, in the engine room, be one or several specific receptacles whose capacity corresponds to at least 1,5 times the quantity of the used oils from the sumps of all of the internal combustion engines and transmissions installed, together with the hydraulic fluids from the hydraulic-fluid tanks.

The connections used in order to empty the receptacles referred to above shall comply with European Standard EN 1305 : 2018.

3. Where vessels are only used on short-haul operation the inspection body may grant exceptions from the requirements of (2).

Article 8.10
Noise emitted by vessels

1. The noise produced by a vessel under way, and in particular the engine air intake and exhaust noises, shall be damped by using appropriate means.
2. The sound pressure level of the noise generated by a vessel under way shall not exceed 70 dB(A) at a lateral distance of 25 m from the ship's side.
3. Apart from transshipment operations, the sound pressure level of the noise generated by a stationary vessel shall not exceed 60 dB(A) at a lateral distance of 25 m from the ship's side.

CHAPTER 9

EMISSION OF GASEOUS AND PARTICULATE POLLUTANTS FROM INTERNAL COMBUSTION ENGINES

Article 9.00 **Definitions**

For the purposes of this Chapter, the following definitions shall apply

1. 'internal combustion engine': an energy converter other than a gas turbine designed to transform chemical energy (input) into mechanical energy (output) with an internal combustion process; it includes, where they have been installed, the emission control system and the communication interface (hardware and messages) between the engine's electronic control unit(s) and any other control unit;
2. 'type-approval': the procedure whereby the competent authority certifies that an engine type or an engine family satisfies the relevant administrative provisions and technical requirements with regard to the levels of gaseous and particulate pollutants emitted by the engine(s);
3. 'engine family': an engine manufacturer's grouping of engines which, through their design, have similar exhaust emission characteristics, and respect the applicable emission limit values;
4. 'reference power': the net power that is used to determine the applicable emission limit values for the engine;
5. 'engine manufacturer': any natural or legal person who is responsible to the approval authority for all aspects of the engine type-approval or authorisation process and for ensuring conformity of engine production, and who is also responsible for market surveillance concerns for the engines produced, whether or not they are directly involved in all stages of the design and construction of the engine which is the subject of the type-approval process.

Article 9.01 **General provisions**

1. The provisions of this Chapter shall apply to all internal combustion engines with a reference power that is greater than or equal to 19 kW installed on board craft.
2. Internal combustion engines comply with the requirements of Regulation (EU) 2016/1628¹. Only internal combustion engines of categories
 - a) IWP,
 - b) IWA,
 - c) NRE with reference power less than 560 kW or
 - d) engines recognized equivalent according to Regulation (EU) 2016/1628shall be installed. This compliance is established by means of a type-approval certificate.

¹ Regulation (EU) 2016/1628 of the European Parliament and of the Council of 14 September 2016 on requirements relating to gaseous and particulate pollutant emission limits and type-approval for internal combustion engines for non-road mobile machinery, amending Regulations (EU) No 1024/2012 and (EU) No 167/2013, and amending and repealing Directive 97/68/EC (OJ L 252, 16.9.2016).

3. The inspection body may require presentation of the type-approval certificate and engine manufacturer's instructions as per Article 9.04 upon each installation, intermediate, or special test.
4. The installation of replacement engines, as defined in Regulation (EU) 2016/1628, is prohibited. However, the repair of an existing engine is permitted in the circumstances referred to in Article 9.10.
5. For the purpose of discharging tasks pursuant to this Chapter, the inspection body may employ a technical service. Only technical services notified according to Regulation (EU) 2016/1628 are recognised for the purpose of this Standard.
6. By way of derogation from Articles 9.01(2) last sentence and (3), 9.02, 9.03, 9.06(2), internal combustion engines that benefit from a field test exemption granted in accordance with Article 34(4) of Regulation (EU) 2016/1628 are permitted. However, the inland navigation vessel certificate shall not be valid for longer than the duration of the field test.

Article 9.02 ***Entry in the inland navigation vessel certificate***

The following data are to be entered in item 52 of the inland navigation vessel certificate for all internal combustion engines installed aboard the craft:

- a) Manufacturer,
- b) Engine type (manufacturer's designation),
- c) Identification number,
- d) Power and engine speed,
- e) If applicable, type-approval number,
- f) Use for which the engine is intended,
- g) Installation location on board,
- h) Date of installation.

Article 9.03 ***Provisions for the installation of internal combustion engines***

The installation of engines in craft shall comply with the restrictions set out in the scope of the type-approval.

Article 9.04 ***Engine manufacturer's instructions***

1. The engine manufacturer's instructions, to be drawn up by the engine manufacturer, shall specify the exhaust relevant components as well as adjustments and parameters, whereby continuous compliance with the exhaust gas emission limit values can be assumed.
2. The instructions contain at least the following details:
 - a) type of engine and, where appropriate, engine family with an indication of the reference power and rated speed;
 - b) list of the components and engine parameters of relevance in an exhaust gas emission context;

- c) unambiguous features to identify the permitted components of relevance in an exhaust gas emission context (e.g. part numbers appearing on the components);
- d) engine parameters of relevance in an exhaust gas emission context such as setting ranges for the injection timing, permitted cooling water temperature, maximum exhaust gas backpressure.

Article 9.05 ***Tests of the internal combustion engines***

1. At the time of the installation test and in the event of intermediate tests and special tests, the inspection body will inspect the current state of the engine with reference to the components, adjustments and parameters specified in the engine manufacturer's instructions.
2. The inspection body shall document tests conducted according to (1).
3. If the installation, intermediate and special tests show that, in relation to their parameters, components and adjustable features, the internal combustion engines installed on board comply with the specifications set out in the documents covered by Article 9.01(3), it may be assumed that the exhaust gas and particulate emissions from the internal combustion engines comply with the limit values.

If the inspection body finds that the internal combustion engine does not comply with the requirements set out in the documents covered by Article 9.01(3), it shall require that steps are taken to re-establish internal combustion engine conformity.

4. In the case of internal combustion engines with exhaust gas after treatment systems, checks shall be carried out to establish that these systems are functioning properly in the context of the installation, intermediate or special tests.

Article 9.06 ***Installation tests***

1. After the installation of the internal combustion engine on board, but before it is brought into service, an installation test shall be carried out. This test, which forms part of the initial inspection of the craft, or of a special inspection by virtue of the relevant internal combustion engine having been installed, shall result either in the registration of the engine in the inland navigation vessel certificate to be issued for the first time or in the modification of the existing inland navigation vessel certificate.
2. During the installation test, the inspection body shall ensure that an engine installed on board still complies with the technical requirements with regard to the level of emissions of gaseous and particulate pollutants, even after undergoing modifications or adaptations since the issuing of the type-approval.

3. The inspection body may dispense with an installation test pursuant to (1), if an internal combustion engine having a reference power output P_N of less than 130 kW is replaced by an internal combustion engine covered by the same type-approval according to Article 9.01(2). As a pre-condition, the inspection body shall be notified of the engine's replacement and shall be provided with a copy of the type-approval document and details of the identification number of the newly installed engine. The inspection body shall make the appropriate amendments to item 52 of the inland navigation vessel certificate.

Article 9.07 ***Intermediate tests***

1. In the event of intermediate tests, the inspection body shall ensure that an engine installed on board still complies with the technical requirements with regard to the level of emissions of gaseous and particulate pollutants, even after undergoing modifications or adaptations since the installation test, have been undergone.
2. Intermediate tests on the internal combustion engine shall be carried out in the context of the craft periodical inspection.

Article 9.08 ***Special tests***

1. In the event of special tests, the inspection body shall ensure that an engine installed on board still complies with the technical requirements with regard to the level of emissions of gaseous and particulate pollutants, after each significant modification.
2. After each significant modification to an engine, where such modifications have the potential to affect the emission of gaseous and particulate pollutants from the internal combustion engine, a special test must invariably be carried out.

Article 9.09 ***Specific requirements concerning exhaust gas after treatment systems***

1. The after-treatment systems shall not impair the safe operation of the craft, including propulsion system and power supply, nor block the exhaust system.
2. When the after-treatment system of internal combustion engines, which ensure the main propulsion of a craft, is equipped with a bypassing device, the bypassing device must comply with the following conditions:
 - a) In the event of a failure of the after-treatment system, the activation of the bypassing device must allow the craft to continue to make steerageway under its own power.
 - b) In the event of activation of the bypassing device, the by-pass device control system shall trigger an acoustic and optical alarm signal in the wheelhouse.
 - c) A by-pass device control system shall record in nonvolatile computer memory all incidents of engine operation with use of the bypassing device. The information shall be readily available for the competent authorities.

3. When a control diagnostic system is installed according to Article 25(3)(f) of Regulation (EU) 2016/1628, the required alarms shall trigger an acoustic and optical alarm signal in the wheelhouse in case of malfunctions.
4. If an after-treatment system relies on the use of a reagent in order to reduce emissions, the required alarms shall alert crew to the need to refill the reagent tank before it is empty, or to replace the reagent if it does not meet the concentration specifications.

When a control diagnostic system installed according to Article 25(3)(f) of Regulation (EU) 2016/1628 can activate power reduction of the internal combustion engine, the following requirements must be fulfilled:

- a) The activation of the power reduction must allow the craft to continue to make steerageway under its own power.
 - b) In the event of activation of the power reduction, the control system shall trigger an acoustic and optical alarm signal in the wheelhouse.
5. The requirement of (1) shall be deemed to be fulfilled when the vessel is equipped with
 - a) a second independent propulsion system (even if that second system also includes an after-treatment system) allowing the craft to continue to make steerageway under its own power; or
 - b) an after-treatment system with a bypassing device according to (2); or
 - c) for a vessel with only a single-engine propulsion system, an alarm system allowing warning of the malfunctioning of the after-treatment system, combined with possibility to override the automatic shutdown of the engine, to continue operation for at least 30 minutes in order to reach a safe berth.
 6. Exhaust gas after treatment systems not already included within the scope of the engine's type-approval are to be entered with the following data in item 52 of the inland navigation vessel certificate for the engine in question:
 - a) Manufacturer,
 - b) Type designation,
 - c) System type.

Article 9.10 ***Repair of engines in service***

1. Engine repairs are permitted provided that:
 - a) they are consistent with the type-approval and the engine manufacturer's instructions;
 - b) the identity of that repaired engine is traceable such that the original engine that was placed on the market and installed on the vessel can be identified.

If the repairs result in the entire engine being replaced, the requirements of Article 9.01(2) shall apply. In particular, if a different identification number is assigned to the engine, it shall then be deemed to be a newly installed engine.

2. When carrying out maintenance or repair of an internal combustion engine with replacement of components, the person or company who carried out such maintenance or repair must provide a report which includes:
- a) date of maintenance or repair,
 - b) description of maintenance or repair work done, including condition of engine before repair and reason for the repair,
 - c) list of components which were replaced or used on the engine, with the specifications of these installed components which show that the engine still complies with the type-approval,
 - d) confirmation that subsequent to repair or maintenance, the engine's specified components, calibration, and parameter settings comply with the engine manufacturer's instructions under Article 9.04,
 - e) when appropriate, the information displayed on the identification plate of the engine pre-repair and post repair,
 - f) when appropriate, supporting pictures.

CHAPTER 10

ELECTRICAL EQUIPMENT AND INSTALLATIONS

Article 10.01

General

1. When no special requirements are specified for certain parts of an electrical installation or an electrical equipment, the safety level shall be considered satisfactory when these parts have been installed in accordance with an approved European Standard or in accordance with the requirements of a recognised classification society.

The relevant documents must be submitted to the inspection body.

2. The following documents bearing the stamp of the inspection body shall be available on board:
 - a) general plans concerning the entire electrical installation;
 - b) plans of the main switchboards, the emergency switchboards, the distribution switchboards, showing the most important technical data such as amperage of the nominal current of fuses and switching devices;
 - c) indications of power requirements for electrical service equipment;
 - d) types of cables indicating conductor cross-sections;
 - e) for electric propulsion systems, a process and instrumentation diagram (PID) of these systems, switchboard plans, arrangement plans of electric service rooms including the location of main components as well as documentation for electric propulsion engines and other main components;
 - f) plans of electronic steering control, regulating, alarm and safety systems;
 - g) control circuit plans.

For unmanned craft, these documents shall not be required to be on board but shall at all times be available with the owner.

3. The equipment and installations shall be designed for a permanent list of the craft of up to 15° and internal ambient temperatures from 0 °C to + 40 °C and on deck from – 20 °C to + 40 °C. They shall be fully functional up to these limits.
4. Electrical equipment and installations shall be easily accessible and easy to maintain.
5. Electrical equipment and installations must be designed and installed so that vibrations which occur in normal service on board do not cause malfunctions or damage.

Article 10.02

Electricity supply systems

1. Where craft are fitted with an electrical installation, that installation shall have at least two power sources in such a way that where one power source fails the remaining source is able to supply the consumer equipment needed for the safe operation for at least 30 minutes.
2. Adequate sizing of the power supply shall be demonstrated by means of a power budget calculation. An appropriate utilisation factor may be taken into account.

3. Independently of (1) above, Article 6.04 shall apply to the power sources for the steering systems.
4. The requirements of (1) above shall not apply to the power sources of electric propulsion systems which are subjected to Chapter 11.

Article 10.03
Protection against access to hazardous parts, against solid foreign objects, against ingress of water

The type of minimum protection for parts of a permanent electrical installation shall be as set out in the following table:

Location	Type of minimum protection in accordance with the European Standard EN 60529 : 2014					
	Generators	Motors	Trans formers	Switchboards Distribution Switching devices	Installation fittings ⁽⁴⁾	Lighting appliances, fire detectors and manual call points
Service rooms, engine rooms and rooms of steering apparatus	IP 22	IP 22	IP 22 ⁽²⁾	IP 22 ⁽¹⁾⁽²⁾	IP 44	IP 22
Holds		IP 55	IP 55		IP 55	IP 55
Accumulator rooms and paint lockers						IP 44 and (Ex) ⁽³⁾
Unroofed decks and open steering positions	IP 55	IP 55		IP 55	IP 55	IP 55
Enclosed wheelhouse	IP 55	IP 22	IP 22	IP 22	IP 22	IP 22
Accommodation, except sanitary and wet rooms				IP 22	IP 20	IP 20
Sanitary and wet rooms		IP 44	IP 44	IP 44	IP 55	IP 44
<p>Comments:</p> <p>(1) Where equipment release large amounts of heat: IP 12.</p> <p>(2) Where the type of protection is not ensured by the equipment itself, the equipment location shall meet the conditions indicated in the table.</p> <p>(3) Certified safe type electrical equipment, for example installations</p> <p style="margin-left: 20px;">a) allowed pursuant to the European Standards series EN 60079 in the version in force on 6 July 2017,</p> <p style="margin-left: 20px;">b) lower minimum type of protection depending on design, e.g. certain types of fire detectors.</p> <p>If lighting devices, fire detectors or manual call points are used in accumulator and paint lockers, both conditions must be complied with.</p> <p>(4) For installation fittings for currents of 125 A and greater: IP 66 (EN 60529 : 2014).</p>						

Article 10.04 ***Protection from explosion***

1. Only electrical equipment that has been explosion proofed (certified safety) may be installed in rooms or areas where explosive atmosphere is likely to accumulate. This equipment must be tested and approved as to its operating safety in an explosive atmosphere by testing institution recognised on the basis of national provisions of one of the Member States.

The installation in these rooms or areas of switching devices for lighting appliances and other electrical equipment is to be avoided as far as possible. The explosion proofing shall take account of the characteristics of the atmosphere that is likely to arise (explosion-potential group, temperature class) and of the requirements of the relevant zone.

Information and restrictions in the approval certificates of the equipment must be observed.

The classification and evaluation of areas at risk of explosion is to be conducted and documented in accordance with International Standards EN 60079-10-1 : 2020 and EN 60079-10-2 : 2015.

2. The applicable rules for hazardous areas:
 - a) In Zone 0 areas only intrinsically safe circuits (protection class Ex ia) in accordance with International Standard IEC 60079-11 : 2012 are permitted.
 - b) In zone 1 areas only explosion-protected electrical equipment (certified safety) is permitted.
 - c) In zone 2 areas measures need to be taken to protect electrical equipment that are appropriate to the type and intended purpose of the service equipment.

Approval in these areas is restricted to:

 - aa) explosion-protected electrical equipment (certified safety) or
 - bb) service equipment, which in normal use do not produce any sparks and whose surfaces might come into contact with the outside air, do not reach impermissible temperatures, or
 - cc) service equipment which is protected by pressurization or which is encapsulated in a vapour-proof manner (minimum protection class IP 55) and whose surfaces do not reach impermissible temperatures.
3. For dust explosion protection, the requirements shall apply according to European Standard EN 60079-10-2 : 2015.
4. Hazardous areas shall bear on the outside a symbol for "Warning for areas where explosive atmospheres may occur" in accordance with Figure 13 of Annex 4, with a side length of at least 10 cm.

Article 10.05 *Earthing*

1. Earthing shall be required for electrical installations with voltages in excess of 50 V.
2. Exposed metal parts which under normal operating conditions are not live, such as electrical system frames and casings of electrical installations and non mobile electrical equipment, shall be earthed separately if they are not so mounted as to be already in electrical contact with the craft's hull.
3. The casings of mobile electric equipment shall be earthed by means of an additional conductor not normally carrying current and incorporated in the supply cable. This requirement shall not apply when an isolation transformer is used or to equipment fitted with protective insulation (double insulation).
4. The cross-section of earth wires shall be at least equal to the values obtained from the following table:

Cross-section of external conductors (S) [mm ²]	Minimum cross-section of earthing conductors	
	in insulated cables [mm ²]	separately mounted [mm ²]
$0,5 \leq S \leq 4$	same cross-section as for the external conductor	4
$4 < S \leq 16$	same cross-section as for the external conductor	
$16 < S \leq 35$	16	
$35 < S \leq 120$	half of the cross-section of the external conductor	
$S > 120$	70	

Article 10.06
Maximum permissible voltages

1. The following voltages shall not be exceeded:

Type of equipment or installation	Maximum permissible voltage		
	Direct current	Single-phase alternating current	Three-phase alternating current
a) Power and heating installations, including the sockets for general use	250 V	250 V	690 V
b) Installations for lighting, for communication, of orders and information, including the sockets for general use	250 V	250 V	-
c) Sockets for current supply to mobile electrical equipment used on open decks or in confined or damp metal-enclosed rooms other than boilers and tanks			
1. general	50 V ⁽¹⁾	50 V ⁽¹⁾	-
2. in the event of isolation transformer serving a single equipment being used	-	250 V ⁽²⁾	-
3. in the event of equipment fitted with protective insulation (double insulation) being used	250 V	250 V	-
4. In the event of use of residual current circuit-breaker $\leq 30\text{mA}$	-	250 V	690 V
d) Mobile electrical equipment (such as electrical devices of containers, engines, fans and pumps) which are not normally adjusted during operation whose exposed conductive parts are earthed by a protective conductor incorporated in the connecting cable and which are connected to the hull, not only by this protective conductor, but by their location or by another conductor	250 V	250 V	690 V
e) Sockets for current supply to mobile electrical equipment used in boilers and tanks	50 V ⁽¹⁾	50 V ⁽¹⁾	-
Comments:			
⁽¹⁾ When this voltage comes from higher voltage networks, a galvanic isolator (isolation transformer) must be used.			
⁽²⁾ The secondary electrical circuit must be insulated from the chassis for all polarities.			

2. If the required protective measures are complied with, higher voltages are permissible:
 - a) for power installations whose power so requires;
 - b) for special installations on board such as radio and ignition devices.
3. The inspection body may allow other exceptions in justified cases if the required protective measures are complied with.

Article 10.07 ***Distribution systems***

1. The following distribution systems are allowed for direct current and single-phase alternating current:
 - a) 2-conductor systems of which one is earthed (L1/N/PE);
 - b) single-conductor systems using the hull return principle, only for local installations (for example, starting installations for internal combustion engines) (L1/PEN);
 - c) 2-conductor systems insulated from the hull (L1/L2/PE).
2. The following distribution systems are allowed for three-phase alternating current:
 - a) 4-conductor systems with earthing of the neutral point, not using the hull return principle (L1/L2/L3/N/PE) = network (TN-S) or network (TT);
 - b) 3-conductor system insulated from the hull (L1/L2/L3/PE) = network (IT);
 - c) 3-conductor with earthing of the neutral point using the hull return principle except for terminal circuits (L1/L2/L3/PEN).
3. The inspection body may allow the use of other distribution systems.

Article 10.08 ***Connection to the shore or other external networks***

1. The feed-in unit, that is the entire onboard equipment for transferring electrical power to the craft, must be designed as follows:
 - a) Transfer from shoreside power supply systems:
 - aa) For currents up to 125 A, the requirements of European Standards EN 15869-1 : 2019 and EN 15869-3 : 2019 are to be complied with.
 - bb) For currents greater than 250 A, the requirements of European Standards EN16840 : 2017 are to be complied with.
 - b) In all other cases, the requirements of (2) to (9) shall apply. The requirements specified shall be deemed to have been complied with if the Standards referred to in (a) are adhered to for the use in question.
2. Incoming supply lines from shore networks or other external networks to the installations of the onboard network shall have a permanent connection on board in the form of permanently fixed terminals or permanently fixed plug sockets. Cables connections shall not be subjected to any pulling load.
3. When the connection voltage exceeds 50 V, the hull shall have an earthing connection. The earthing connection should be specially marked.

4. The protective devices of the connections shall be capable of being locked so as to prevent the concurrent operation of the onboard network generators and the shore network or another external network. A brief period of concurrent operation shall be permitted when changing from one system to another without a break in voltage.
5. The connection shall be protected against short circuits and overloads.
6. The main switchboard shall indicate whether the connection is live.
7. Indicator devices shall be installed to allow comparison of polarity in the case of direct current and phase sequence in the case of alternating current between the connection and the onboard network.
8. A panel on the connection shall indicate:
 - a) the measures required to make the connection;
 - b) the kind of current and the nominal voltage and, for alternating current, the frequency.
9. If sockets devices rated at more than 16 A are used, steps shall be taken to ensure that connection and disconnection can take place only when the line is dead.

Article 10.09
Power supply to other craft

1. When power is applied to other craft, a separate connection must exist.
2. Article 10.08(2) and (4) to (9) shall apply *mutatis mutandis*.

Article 10.10
Generators, engines and transformers

1. Generators driven by the main engine, the propeller shaft or by an auxiliary set intended for another function shall be designed as a function of the range of rotational speeds which can occur during operation.
2. Transformers must be installed in well-ventilated locations or in well-ventilated rooms.
3. Primary and secondary windings of transformers shall be executed in an electrically isolated manner. Autotransformers are excluded hereof.
4. Corresponding tapings of the nominal voltage shall be provided for setting the secondary voltage of transformers. Autotransformers are excluded hereof.
5. Engines, generators, and transformers shall be provided by the manufacturer with a plate, which in addition to the company name, the machine's serial number and the rated power must contain the essential rating data.

Article 10.11

Batteries, Accumulators and their charging devices

1. Accumulators shall be accessible and so arranged as not to shift with movements of the craft. They shall not be placed where they will be exposed to excessive heat, extreme cold, spray, steam or vapour.
2. Accumulators shall not be installed in the wheelhouse, accommodation, lounges and holds and in the case of passenger vessels in passenger rooms, cabins and galleys. The first sentence shall not apply for accumulators:
 - a) in mobile equipment; or
 - b) with charging power of less than 0,2 kW.
3. Accumulators requiring a charging power of more than 2,0 kW shall be installed in a special room. If placed on deck, they may also be enclosed in a cupboard. If gas can escape from accumulators, this room or cupboard must be mechanically ventilated to the open deck (supply and exhaust air).
4. The charging power is calculated on the basis of the maximum charging current and the nominal voltage of the accumulator, taking into account the characteristic charging curves of the charging device.
5. Accumulators requiring a charging power not exceeding 2,0 kW may also be installed below decks in a cupboard or chest. They may also be installed without casing in an engine room, electrical service room or any other well-ventilated place provided that they are protected against falling objects and dripping water.
6. The interior surfaces of all rooms, cupboards or chests, as well as shelving or other components intended for accumulators shall be protected against the harmful effects of the electrolyte.
7. Provision shall be made for effective ventilation when accumulators are installed in a closed room, cupboard or chest. Mechanical ventilation shall be provided for charging power of more than
 - a) 2,0 kW for nickel-cadmium accumulators;
 - b) 3,0 kW for lead accumulators.

The air shall enter at the bottom and be discharged at the top so that a total evacuation of gases is ensured.

Ventilation ducts shall not include devices which obstruct the air flow such as stop valves.

8. The required air throughput (Q) shall be calculated by the following formula:

$$Q = f \cdot I_{gas} \cdot n \text{ [m}^3\text{/h]}.$$

where

$f =$ 0,11 for accumulators with liquid electrolytes;

$f =$ 0,03 for accumulators with enclosed cells (electrolyte immobilised in gel, non-woven fibrous material);

$I_{gas} =$ $\frac{1}{4}$ of the maximum current of the charging device in A;

$n =$ number of cells in series circuit.

In the case of buffer accumulators of the onboard network, other methods of calculation taking into account the characteristic charging curve of the charging devices may be accepted by the inspection body, provided that these methods are based on the provisions of recognised classification societies or on relevant standards.

9. Where natural ventilation is used, the cross-section of the air ducts shall be sufficient for the required air throughput on the basis of an air flow velocity of 0,5 m/s. However, the cross section shall have a minimum value of
 - a) 80 cm² for lead accumulators;
 - b) 120 cm² for nickel-cadmium accumulators.
10. Where mechanical ventilation is used, a fan shall be provided, preferably with an exhaustor device; its motor shall be clear of the gas stream and the air stream. Fans shall be of a construction precluding the production of sparks through contact between a blade and the fan casing and shall avoid any electrostatic charges.
11. A symbol for 'Fire, naked flame and smoking prohibited' in accordance with figure 2 of Annex 4 with a diameter of at least 10 cm shall be affixed to the doors or covers of accumulator rooms, cupboard or chest.
12. Charging devices must basically be designed so that discharged accumulators can be re-charged within a maximum of 15 hours to 80 % of their nominal capacity, without exceeding the amperage of maximum permissible charge rate.
13. Only automatic charging devices which correspond to the charging characteristics of the accumulator type must be used.
14. For the simultaneous supply of consumer equipment while charging, the power requirements of the consumer equipment must be taken into account when selecting the charger. A charging voltage of up to a maximum of 120 % of the rated voltage must be observed irrespective of the current power requirements. The figure increases to 125 % for traction batteries.
15. The requirements of European Standard EN 62619 : 2022 and EN 62620 : 2023 shall apply for lithium-ion accumulators.
16. Accumulator management systems for monitoring the accumulators are to be used if possible. Lithium-ion accumulators must be equipped with such systems.

These systems shall at a minimum comprise the following functionality:

- a) cell protection (short-circuit, external, internal, overcurrent, deep discharge, etc.);
- b) charge control, provided this is not by means of the charger;
- c) load management;
- d) determination of the charge level;
- e) balancing of the cells;
- f) thermal management.

Depending on use, if possible, they should also feature the following functionality:

- g) determination of ageing, remaining capacity, internal resistance etc.;
- h) communication (e.g. with inverters and control devices);

- i) authentication and identification;
 - j) history.
17. Rooms in which lithium-ion accumulators are stored shall comply with the following requirements:
- a) These rooms shall be protected against fire of one or several lithium-ion accumulators on the basis of a fire protection concept developed by an expert
 - aa) having regard to the other equipment located in the same room,
 - bb) having regard to instructions of the manufacturer of the lithium-ion accumulators,
 - cc) including provisions for alarm systems.

A fire protection concept may be dispensed with if the lithium-ion accumulators are stored in a fireproof enclosure, which is equipped

 - dd) with at least one monitoring device (fire and thermal runaway) and
 - ee) with one fixed fire-extinguishing installation for protecting objects in accordance with Article 13.06.
 - b) In the case referred to in (a) first sentence, these rooms shall be shielded with A60 partitions.
 - c) These rooms or the lithium-ion accumulators housed in a fireproof enclosure shall be mechanically ventilated to the open deck. The exhaust outlet of the ventilation shall be located in such a way that the safety of persons on board is not endangered.
- These requirements do not apply if the cumulative capacity of the lithium-ion accumulators in the room is below 20 kWh.
18. The name of the manufacturer, serial number, type and installation date of the lithium-ion accumulators shall be entered in item 52 of the inland navigation vessel certificate.
19. The requirements of (15), (16), (17) and (18) do not apply to accumulators in mobile equipment or with a charging power of less than 0,2 kW.
20. For batteries, (1) to (12) and (16) shall apply *mutatis mutandis*.

Article 10.12 ***Switchgear and controlgear***

1. Switchboards
- a) Equipment, switches, fuses and switchboard instruments shall be arranged visibly and shall be accessible for maintenance and repair.
Terminals for voltages up to 50 V and for voltages greater than 50 V shall be kept separate and marked appropriately.
 - b) For all switches and equipment, marker plates indicating the circuit shall be affixed to switchboards.
The nominal amperage and the circuit shall be indicated for fuses.
 - c) When equipment with an operating voltage greater than 50 V are installed behind doors, the current-carrying components of these equipment shall be protected against accidental contact while the doors are open.
 - d) The materials of switchboards shall have suitable mechanical strength, be durable, flame-retardant, self-extinguishing and not be hygroscopic.

- e) If low voltage - high rupturing capacity fuses are installed in switchboards, accessories and equipment for bodily protection shall be available for installing and removing such fuse-links.
2. Switches, protective devices
- a) Generator circuits and consumer equipment circuits shall be protected against short circuits and overcurrent on all non-earthed conductors. Switching devices triggered by short-circuiting and overload or fuses (with fuse-links) may be used for this purpose.
- Circuits supplying the steering system according to Article 6.04 and their control circuits shall be protected only against short circuits. When circuit-breaker include thermal release, these shall be neutralised or set at not less than twice the nominal amperage.
- b) Outputs to consumer equipment from the main switchboard shall include a load switch or circuit-breaker for nominal amperage greater than 16 A
- c) Consumer equipment required for propelling the vessel, for the steering systems according to Chapter 6, for the rudder position indicators, for navigation or for safety systems as well as consumer equipment, with a nominal amperage greater than 16 A shall be supplied by separate circuits.
- d) The circuits of consumer equipment required for propelling and manoeuvring the vessel shall be supplied directly by the main switchboard.
- e) Switching devices shall be selected on the basis of nominal amperage, thermal or dynamic strength and their breaking capacity. Switches shall simultaneously cut off all live conductors. The switching position shall be easily identifiable.
- f) Fuse-links must be of the enclosed-melt type and be made of porcelain or an equivalent material. It shall be possible to change them without any danger of contact.
3. Measuring and monitoring devices
- a) Generator, accumulator and distribution circuits shall be equipped with measuring and monitoring devices required for the safe operation of the installation.
- b) Non-earthed networks where the voltage is higher than 50 V must include a device for monitoring insulation equipped with an optical and acoustic alarm. In secondary installations such as control circuits, this device for monitoring insulation may be dispensed with.
4. Placement of switchboards
- a) Switchboards shall be placed in accessible and sufficiently ventilated rooms, in order to be protected against water and mechanical damage.
- Piping and air ducts shall be so arranged that in the event of leakage the switchgear and controlgear cannot be damaged. If they have imperatively to be installed near switchboards, pipes shall not have removable connections in the vicinity.
- b) Cupboards and wall recesses in which unprotected switching devices are installed shall be of a flame-retardant material or protected by a metal or other non-flammable sheathing.
- c) When the voltage is greater than 50 V, gratings or insulating mats shall be placed in front of the main switchboard where the operator sits.

Article 10.13

Emergency circuit-breaker devices

For oil burners, oil and fuel pumps, oil and fuel separators and engine room ventilators, emergency circuit-breaker devices shall be installed in central location outside the rooms containing the equipment.

Article 10.14

Installation fittings

1. Cable entries shall be sized as a function of the cables to be connected and be appropriate to the types of cable used.
2. Sockets for distribution circuits at different voltages or frequencies shall be impossible to confuse.
3. Switches shall simultaneously switch all non-earthed conductors within a circuit. However, single-pole switches within non-earthed circuitry shall be permitted in accommodation-lighting circuits apart from in laundries, washrooms and other rooms with wet facilities.
4. Where amperage exceeds 16 A it shall be possible to lock the sockets by means of a switch in such a way that the plug can only be inserted and withdrawn with the power switched off.

Article 10.15

Cables, insulated cables and cable systems

1. Cables shall be flame-retardant, self-extinguishing and resistant to water and oil.

In accommodation, the inspection body may authorise the use of other types of cables, provided they are effectively protected, flame-retardant or self-extinguishing.

For determining that electric cables are flame-retardant, shall

- a) the provisions of European Standards series EN 60332 : 2020 or
 - b) equivalent regulations of one of the Member States
- be recognised.

2. Conductors wires of cables used for power and lighting circuits shall have a minimum cross-section of 1,5 mm² per conductor.
3. Metal armouring, shielding and sheathing of cables shall not, under normal operating conditions, be used as conductors or for earthing.
4. Metal shielding and sheathing of cables in power and lighting installations shall be earthed at least at one end.

5. The cross-section of conductor wires shall comply with the final permissible maximum temperature of conductor wires (maximum permissible amperage) and permissible voltage drop. Such a drop between the main switchboard and the least favourable point of the installation shall not be more than 5 % of nominal voltage for lighting and more than 7 % for power or heating installations.
6. Cables shall be protected against mechanical damage.
7. Cable connections must be protected against mechanical load and against pulling load
8. When cables pass through bulkheads or decks, the mechanical strength, water tightness and required fire protection properties (e.g. non-combustible, flame-retardant, fire-resistant) of these bulkheads and decks shall not be affected by these cable penetrations.
9. Terminations and connections of all conductors must be designed so that the original electrical, mechanical, fire protection properties (e.g. non-combustible, flame-retardant, fire-resistant) of the cable are preserved. This requirement shall have been fulfilled if the terminations and the connections meet:
 - a) the International Standard IEC 60092-352 : 2005 number 3.28 in conjunction with Annex D of the standard or
 - b) equivalent regulation or Standard recognised by one of the Member States.The number of cable connections must be restricted to a minimum.

For repaired or replaced cables, sentence 1 shall have been fulfilled if the cable connections comply with International Standard IEC 60092-352 : 2005 number 3.28 in conjunction with Annex D of the standard, or rules recognised by a Member State as being equivalent.
10. Cables connected to elevating wheelhouses shall be sufficiently flexible and be fitted with insulation with sufficient flexibility at temperatures down to – 20 °C and resistant to steam and vapour, ultraviolet rays and ozone.
11. When setting up cable harness penetrations, the fire protection properties of the partition must not be impaired. This shall be deemed to be met if the cables meet the provisions of the European Standard series EN 60332 : 2020 or one of the rules recognised as an equivalent by a Member State. If this is not the case, fire stop equipment must be provided in the penetrations for long cable harnesses (more than 6 m vertical and 14 m horizontal) if the cables are not completely enclosed by cable ducts.
12. Cables from an emergency electrical power source to consumer equipment must be laid as far as possible in the safe area.
13. The running of cables through areas with high ambient temperatures should be avoided. If this is not possible,
 - a) the ambient temperatures must be taken into account when determining the maximum permissible amperage or
 - b) the cable must be protected against damage by heat and fire.

14. Main and emergency power supply cables must not run through the same room. The inspection body may waive this requirement if:
 - a) main and emergency power supply cables are laid as far apart from each other as possible or
 - b) the emergency power supply cables are fire-resistant. This requirement shall have been fulfilled if they satisfy the requirements of the International Standards series IEC 60331 in the version in force on 6 July 2017.

Article 10.16 ***Lighting installations***

1. Lighting appliances shall be so installed that the heat they emit cannot set fire to nearby inflammable objects or components.
2. Lighting appliances on open decks shall be so installed as not to impede the recognition of signal lights.
3. When two or more lighting appliances are installed in an engine room or boiler room, they shall be distributed between at least two circuits. This requirement shall also apply to rooms where cooling machinery, hydraulic machinery or electric motors are installed.

Article 10.17 ***Navigation lights***

1. Switchboards for navigation lights shall be installed in the wheelhouse. They shall be supplied by a separate cable from the main switchboard or by two independent secondary networks.
2. Navigation lights shall be supplied, protected and controlled separately from the navigation lights switchboard.
3. A failure of the device according to Article 7.05(2) shall not impair the operation of the navigation lights which it monitors.
4. Several signal lamps forming a functional unit and installed together at the same point may be jointly supplied, controlled and monitored. The monitoring device shall be capable of identifying the failure of any one of these lights. It shall not be possible to use both light sources in a double light (two lights mounted one above the other in the same housing) simultaneously.

Article 10.18 ***Power electronics***

1. A separate device for disconnecting from the mains must be provided for each power electronics system. The combination fuse – switch may be used for consumer equipment up to a nominal current of 315 A. In all other cases, a circuit-breaker must be provided on the network side.
2. The power electronics should be readily accessible for repairs and measurements. Appropriate devices must be provided for checking functions and detecting malfunctions.

3. Control and signal electronics must be galvanically separated from power circuits.
4. Converter systems must ensure safe operation even with the largest permissible voltage and frequency fluctuations. For impermissibly high frequency and/or voltage variations in the supply voltage, the system must switch itself off or remain in a safe operating condition.
5. Electric charges in assemblies should be reduced to a voltage below 50V in less than 5 seconds after disconnecting from the network. If longer discharge times are required, a warning sign must be affixed to the device.
6. The failure of external control signals, must not lead to a dangerous condition.
7. Power electronics must be designed and installed in such a way that the failure of control voltages cannot lead to threats or damage to the system or device where the power electronics is installed, or to the overall system.
8. In installation which is required for propulsion and manoeuvrability as well as safety of the crew, craft or cargo, components must be provided for monitoring the individual power electronic assemblies and subsystems in order to facilitate error detection in the event of a malfunction and prevent the existence of undetected errors.
9. The monitoring of the power electronics must detect errors with certainty and prevent them from remaining unrecognised.
10. Except for components, only power electronics that have undergone type examination may be used. If the power electronics feature protective and monitoring devices, the examination must also include proof of the response thresholds and coordinated interaction of all protective and monitoring equipment. The type examination report is to be included with the system documentation.

Article 10.19

Alarm and safety systems for mechanical installations

Alarm and safety systems for monitoring and protecting mechanical equipment shall meet the following requirements:

1. Alarm systems:

Alarm systems shall be so constructed that a failure in the alarm system cannot result in a failure of the equipment or installation being monitored.

Binary transmitters shall be designed on the rest-current principle or on the supervised operating current principle.

Optical alarms shall remain visible until the malfunction has been remedied; an alarm with acknowledgement shall be distinguishable from an alarm without acknowledgement. Each alarm shall also comprise an acoustic signal. It shall be possible to switch off acoustic alarms. Switching off one alarm signal shall not prevent another signal from being set off by other causes.

Exceptions shall be permitted by the inspection body in the case of alarm systems comprising less than five measurement points.

2. Safety systems:

Safety systems shall be designed to halt or slow down the operation of the affected installation or to signal a permanently manned station to do so before a critical state is reached.

Binary transmitters shall be designed according to the operating current principle.

If safety systems are not designed to be self-monitoring, their operation must be verifiable.

Safety systems must be independent of other systems.

Article 10.20
Test conditions for electronic installations

1. General

The test conditions in (2) shall apply only to electronic equipment that are necessary for the steering system and the craft's propulsion machinery, including their ancillaries.

2. Test conditions

a) The stresses arising from the following tests shall not cause electronic equipment to be damaged or to malfunction. The tests in accordance with relevant International Standards, such as IEC 60092-504 : 2016, apart from the cold-condition test, shall be carried out with the equipment switched on. These tests shall include checking of proper operation.

b) Variations in voltage and frequency

	Parameters	Variations	
		continuous	Short-duration
General	Frequency voltage	± 5 % ± 10 %	± 10 % 5 s ± 20 % 1,5 s
Battery operation	voltage	+ 30 % / - 25 %	-

c) Heating test

The sample is brought up to a temperature of 55 °C within a half-hour period. After that temperature has been reached it is maintained for 16 hours. An operating test is then carried out.

d) Cold-condition test

The sample is switched off and cooled to -25 °C and held at that temperature for two hours. The temperature is then raised to 0 °C and an operating test is carried out.

e) Vibration test

The vibration test shall be carried out along the three axes at the resonance frequency of the equipment or of components for the period of 90 minutes in each case. If no clear resonance emerges the vibration test shall be carried out at 30 Hz.

The vibration test shall be carried out by sinusoidal oscillation within the following limits:

General:

$f = 2,0$ to $13,2$ Hz; $a = \pm 1$ mm

(amplitude $a = 1/2$ the vibration width)

$f = 13,2$ Hz to 100 Hz: acceleration $\pm 0,7$ g.

Service equipment intended to be fitted to internal combustion engines or steering apparatus shall be tested as follows:

$f = 2,0$ to 25 Hz; $a = \pm 1,6$ mm

(amplitude $a = 1/2$ the vibration width)

$f = 25$ Hz to 100 Hz; acceleration ± 4 g.

The sensors intended to be installed in internal combustion engine exhaust pipes may be exposed to considerably higher stresses. Account shall be taken of this during the tests.

3. The electromagnetic compatibility test shall be carried out on the basis of European Standards EN 61000-4-2 : 2009, EN 61000-4-3 : 2020, EN 61000-4-4 : 2012, at test degree number 3.
4. Proof that the electronic equipment is adequate for these test conditions shall be provided by their manufacturer. A certificate by a recognised classification society is also considered as a proof.

Article 10.21 ***Electromagnetic compatibility***

The operation of the electric and electronic installations shall not be impaired by electromagnetic interference. General measures shall, with equal importance, extend to:

- a) disconnection of the transmission paths between the source of interference and affected equipment;
- b) reducing the causes of disturbance at their source;
- c) reducing the sensitivity of affected equipment to interference.

CHAPTER 11

SPECIAL PROVISIONS APPLICABLE TO ELECTRIC PROPULSION SYSTEMS

Article 11.00 **Definitions**

For the purposes of this Chapter, the following definitions shall apply

1. 'electric propulsion system' a propulsion system where the propulsor is driven by (an) electric engine(s), independent of the actual source of electric energy (on-board power network, separate power supply etc.);
2. 'electric propulsion engine' an electric engine driving a propulsor.

Article 11.01 **General provisions for electric propulsion systems**

1. In addition to the applicable requirements of Chapter 8, this Chapter applies to electric propulsion systems.
2. An electric propulsion system shall consist of at least
 - a) the appropriate number of electrical power sources
 - aa) one electrical power source for an electric propulsion system with a single main propulsor;
 - bb) two electrical power sources for an electric propulsion system with more than one main propulsors,
 - b) the corresponding switchgear pursuant to Article 10.12,
 - c) an electric propulsion engine,
 - d) the respective control, monitoring and alarm equipment pursuant to Articles 7.03 and 7.04 and
 - e) depending on the design of the electric propulsion system, the corresponding power electronics.
3. A malfunction of the electric propulsion system shall not obstruct the operation of the vessel such that the emergency systems provided for in accordance with this Standard, in particular the steerageway under its own power or the emergency electrical power supply, are affected.
4. Two electric propulsion systems can only be deemed independent if
 - a) the power supply circuits of the electric propulsion engines are completely separate from one another, or
 - b) a FMEA-S safety study demonstrates that no failure of one electric propulsion system impairs the operation of the other, or

- c) they can be separated from each other by a separating device automatically activated in case of malfunction or failure of one of the electric propulsion systems and that can in addition be activated manually. The separating device shall provide
 - aa) downstream and upstream short circuit selectivity,
 - bb) breaking capacity for the maximum short circuit current, and
 - cc) an isolating separation between the two electric propulsion systems, enabling safe access to a powered down subsection.
5. Each electric engine shall be provided with a manually operated and dedicated emergency shut-down device outside the wheelhouse . This requirement is deemed to be fulfilled if electric engines can be switched off at their respective switchboards. Emergency shut-down devices shall be protected against unintended activation.
6. Electrical power sources must be designed in such a way that, taking into account the concept of the electric propulsion system, they can absorb the power feedback occurring during reversing manoeuvres.

Article 11.02

Generators, transformers and switchgear for electric propulsion systems

1. The generators, transformers and switchgear must be designed for
 - a) temporary overloads and
 - b) the effects of manoeuvresaccording to their application and operating conditions.
2. The fuel regulators of the internal combustion engines for generators of electric propulsion systems shall ensure safe operation over the entire speed range and for all sailing and manoeuvring conditions in single and parallel operation. This provision shall apply *mutatis mutandis* to fuel regulators of fuel cells.
3. Where generators are elements of an integrated power supply, electric propulsion system shall not be interrupted when individual generators are switched on or switched off.

Article 11.03

Electric propulsion engines for electric propulsion systems

1. Electric propulsion engines, taking into account their application and operating conditions, must be designed in such a way that load changes, including brief overloads, and manoeuvres do not impair their safe operation.
 2. Electric propulsion engines must be designed in such a way that harmonics of currents and voltages do not impair their safe operation.
 3. The insulation of the windings must be designed for overvoltages, which can occur due to manoeuvres and switching operations. This is deemed fulfilled if the material of the windings complies with classes B, F or H in accordance with the European standard EN 60085 : 2008.
- 

Article 11.04
Power electronics for electric propulsion systems

1. The power electronics requirements according to Articles 10.18 and 10.20 shall apply with the following provisions.
2. Power electronics must be designed for the anticipated loads, including overload during all operating and manoeuvring conditions.
3. If power electronics are externally cooled, they must, if their cooling system fails, be able to continue operating with reduced power so that the vessel is at least capable of making steerageway under its own power for 30 minutes. This requirement does not apply if a second independent electric propulsion system in accordance with Article 11.01(4) is present.
4. Excitation circuits, the failure of which can endanger safe operation, may only be protected against short circuits.

Article 11.05
Monitoring equipment

The operating conditions and operation of the electric propulsion system are to be documented in a non-volatile computer memory such that faults can be readily analysed in a verifiable manner. This requirement does not apply to electric propulsion systems with a total power of less than 100 kW.

Article 11.06
Control, regulation and automatic power limitation

1. The control and regulation equipment of the energy supply system from which an electric propulsion system is supplied shall prevent overloading of its power sources, its supply system and its consumer equipment by
 - a) timely connecting additional power sources or
 - b) disconnecting loads not required for the safe operation of the vessel, or
 - c) only in case the measures under aa) and bb) are not sufficient to equalise the power imbalance, limiting the power of the electric propulsion system for a short time. The limitation shall automatically end when the overload can no longer occur.
2. Connecting other consumer equipment and further electric propulsion engines must not lead to a power limitation of the electric propulsion systems.
3. In the event of individual propulsion units being shut down as a result of an automatic power limitation, the propulsion asymmetry is to be kept to a minimum.

Article 11.07
Protection of the electric propulsion systems

1. Protective devices must be set so that they are not triggered in the event of situations referred to in Articles 11.02(1) and 11.03(1).

2. In the event of a malfunction or failure of the control or regulation system of the electric propulsion systems:
 - a) the propeller speed must not increase to inadmissible levels; and
 - b) the propulsion must not reverse of its own accord.
3. Each electric propulsion engine is to be fitted with
 - a) earth fault monitoring;
 - b) differential protection or equivalent protective device.
4. The following additional protective devices must be provided:
 - a) protection against overcurrent and short circuit;
 - b) protection against harmful bearing currents on the electric propulsion engine by means of steep voltage edges.
5. It must be ensured when protective devices are triggered that:
 - a) malfunctioning subsystems are selectively switched off or, where required, the power of the electric propulsion system is limited in accordance with Article 11.06; or
 - b) where required, the electric propulsion system is shut down in a controlled manner; or
 - c) the power stored in components and in the load circuit cannot have a detrimental impact when they are switched off.
6. To protect the electric propulsion system against undervoltage appropriate measures shall be taken to
 - a) separate affected components from the rest of the electric propulsion system and
 - b) prevent components from being switched on if their power demand can cause undervoltage of the power source.

Separating devices shall provide breaking capacity for the maximum short-circuit current.

Article 11.08 ***Testing of the electric propulsion systems***

1. The test concept envisaged by the manufacturer or the system integrator of the electric propulsion system must be submitted to the inspection body before being put into service for the first time. The latter may demand additional testing and proof confirming the safe operation of the electric propulsion system and its functions. This applies in particular to those instances where the craft is required to be capable of making steerageway under its own power in the event of malfunctions.
2. The test concept shall cover at least:
 - a) navigation under utilisation of electric propulsion systems at full power and normal operation of all other consumer equipment on board;
 - b) navigation under utilisation of electric propulsion systems at normal operation with reduced load factor of power sources with testing of switching on and off of the different power sources;
 - c) testing of the electric propulsion systems during navigation
 - aa) in the event of failure of a power source as well as undersupply of the electric propulsion systems (worst-case scenario);

- bb) in case of failure of external cooling of power electronics or propulsion engines;
- cc) in case of failure of control and regulation systems of the electric propulsion systems, and
- dd) during a stopping manoeuvre (independent of the length of the vessel),
- d) where appropriate, testing of independence of electric propulsion systems during navigation
 - aa) in the event of failure of one element of one of the electric propulsion systems.

In addition, it has to be demonstrated that in the event of one of the failures as referred to under (c) the vessel is capable of making steerageway under its power.

The inspection body may require additional tests or documentation.

3. The electric propulsion system shall be checked by an inspection body:
 - a) before being put into service for the first time,
 - b) before being put back into service after any major modification or repair,
 - c) on every periodical inspection.

CHAPTER 12
ELECTRONIC EQUIPMENT AND SYSTEMS

(left void)

CHAPTER 13 EQUIPMENT

Article 13.01 Anchor equipment

1. Vessels intended for the carriage of goods, apart from ship-borne lighters whose length L does not exceed 40 m, shall be equipped with bow anchors whose total mass P is obtained using the following formula:

$$P = k \cdot B \cdot T \text{ [kg]}$$

where

k is a coefficient that takes account of the relationship between length L and beam B , and of the type of vessel:

$$k = c \sqrt{\frac{L}{8 \cdot B}}$$

for lighters, however, $k = c$ will be taken;

c is an empirical coefficient given in the following table:

Dead-weight tonnage [t]	Coefficient c
up to 50 inclusive	20
from 50 to 100 inclusive	25
from 100 to 200 inclusive	30
from 200 to 400 inclusive	45
from 400 to 650 inclusive	55
from 650 to 1000 inclusive	65
more than 1000	70

2. a) Passenger vessels and vessels not intended for the carriage of goods, apart from pushers, shall be fitted with bow anchors whose total mass P is obtained using the following formula:

$$P = k \cdot B \cdot T \text{ [kg]}$$

- b) By way of derogation from (a) and having regard to the applicable navigational authority regulations for certain areas of navigation in the Member States, for passenger vessels, for whose bow anchors the total mass P has been obtained by the following formula it shall be entered in item 52 of the inland navigation certificate that the total mass of the bow anchors meets the requirements set out in Article 13.01(2)(b):

$$P = k \cdot B \cdot T + 4 A_f \text{ [kg]}$$

where:

k is the coefficient corresponding to (1), but where in order to obtain the value of the empirical coefficient c the water displacement in m^3 entered in the inland navigation vessel certificate shall be taken instead of the deadweight tonnage.

A_f is the frontal projected area exposed to the wind, in m^2 .

3. Vessels referred to in (1) whose length L does not exceed 86 m shall be equipped with stern anchors whose total mass is equal to 25 % of mass P .

Vessels whose length L exceeds 86 m shall be equipped with stern anchors whose total mass is equal to 50 % of mass P calculated in accordance with (1) or (2).

Stern anchors are not required for:

- a) vessels for which the stern anchor mass will be less than 150 kg;
- b) lighters.

4. Vessels intended to propel rigid convoys which do not exceed 86 m in length shall be equipped with stern anchors whose total mass is equal to 25 % of maximum mass P calculated in accordance with (1) for the formations (considered to be a nautical unit) permitted and entered in the inland navigation vessel certificate.

Vessels intended to propel rigid convoys which exceed 86 m in length downstream shall be equipped with stern anchors whose total mass is equal to 50 % of the maximum mass P calculated in accordance with (1) for the formations (considered to be a nautical unit) permitted and entered in the inland navigation vessel certificate.

5. The anchor masses established in accordance with (1) to (4) may be reduced for certain special anchors.
6. The total mass P specified for bow anchors may be distributed between one or two anchors. It may be reduced by 15 % where the vessel is equipped with only a single bow anchor and the hawse pipe is located amidships.

The total mass required for stern anchors for pushers and vessels whose maximum length exceeds 86 m may be distributed between one or two anchors.

The mass of the lightest anchor shall not be less than 45 % of that total mass.

7. Cast iron anchors shall not be permitted.
8. On anchors their mass shall be indicated in characters which stand out in relief in a durable manner.
9. Anchors having a mass in excess of 50 kg shall be equipped with windlasses.
10. Each bow anchor chain shall have a minimum length of:
 - a) 40 m for vessels whose length L does not exceed 30 m;
 - b) at least 10 m longer than the length L of the vessel where this is between 30 and 50 m;
 - c) 60 m for vessels whose length L exceeds 50 m.

Each of the stern anchor chains shall be at least 40 m long. However, where vessels need to stop facing downstream they shall have stern anchor chains that are each at least 60 m in length.

11. The minimum breaking load R of the anchor chains shall be calculated using the following formulae:

- a) anchors having a mass up to 500 kg:

$$R = 0,35 \cdot P' [kN]$$

- b) anchors having a mass of more than 500 kg and not exceeding 2000 kg:

$$R = \left(0,35 - \frac{P' - 500}{15000} \right) P' [kN]$$

- c) anchors having a mass of more than 2000 kg:

$$R = 0,25 \cdot P' [kN]$$

where

P' is the theoretical mass of each anchor determined in accordance with (1) to (4) and (6).

The breaking load of anchor chains shall be stated according to a standard in force in one of the Member States.

12. Where the anchors have a mass greater than that required by (1) to (6), the breaking load of the anchor chain shall be determined as a function of the actual anchor mass.

In cases where heavier anchors with correspondingly stronger anchor chains are aboard, only the minimum masses and minimum breaking loads required according to (1) to (6) and (11) shall be entered in the inland navigation vessel certificate.

13. Connecting pieces, such as swivels or shackles, between anchor and chain shall withstand a tensile load 20 % higher than the breaking load of the corresponding chain
14. The use of wire cables instead of anchor chains is permitted. The cables shall have the same breaking load as that required for chains, but shall be 20 % longer.

Article 13.02 ***Other equipment***

1. At least the following equipment in accordance with the applicable navigational authority regulations in force in one of the Member States shall be onboard:
- a) radio-telephone equipment;
 - b) appliances and devices necessary for emitting visual and acoustic signals and for marking the vessel;
 - c) stand-alone back-up lights for the prescribed mooring lights.

2. The following receptacles must also be present:
- a) a marked receptacle for domestic waste;
 - b) separate, marked receptacles, with sealing covers, made of steel or another sturdy, non-flammable material, of adequate size but holding at least 10 litres, for the collection of
 - aa) oily cleaning cloths;
 - bb) hazardous or pollutant solid wastes;
 - cc) hazardous or pollutant liquid wastes;
 and, inasmuch as they may arise, for the collection of
 - dd) slops;
 - ee) other oily or greasy waste.

3. In addition, the equipment shall include at least:

- a) mooring cables;

Vessels shall be equipped with three mooring cables. Their minimum lengths shall be at least the following:

first cable: $L + 20 \text{ m}$ but not more than 100 m,

second cable: $2/3$ of the first cable,

third cable: $1/3$ of the first cable.

The shortest cable is not required on board vessels whose L is less than 20 m.

The cables shall have a breaking load R_s that is calculated using the following formulae;

$$\text{for } L \cdot B \cdot T \text{ up to } 1000 \text{ m}^3: R_s = 60 + \frac{L \cdot B \cdot T}{10} \text{ [kN]};$$

$$\text{for } L \cdot B \cdot T \text{ exceeding } 1000 \text{ m}^3: R_s = 150 + \frac{L \cdot B \cdot T}{100} \text{ [kN]}.$$

For the required cables a certificate in accordance with European Standard EN 10204 : 2004, under No 3.1, shall be on board.

These cables may be replaced by ropes having the same length and breaking load. The minimum breaking load of these ropes shall be indicated in a certificate.

- b) towing cables;

Tugs shall be equipped with a number of cables that are suitable for their operation.

However, the main cable shall be at least 100 m long and have a breaking load, in kN, not less than one third of the total power, in kW, of the main engine(s).

Motor cargo vessels, motor tankers and pushers that are able to tow shall be equipped with a towing cable that is at least 100 m long and whose breaking load, in kN, is not less than one quarter of the total power, in kW, of the main engine(s).

- c) a heaving line;
- d) a boarding gangway at least 0,40 m wide and 4 m long whose side edges are defined by a brightly-coloured strip; that gangway shall be equipped with a handrail. The inspection body may permit shorter gangways for small vessels;
- e) a gaff hook;

- f) an appropriate first-aid kit with a content in accordance with a relevant standard of a Member State. The first-aid kit shall be kept in an accommodation room or in the wheelhouse and be stored in such a way that it is easily and safely accessible if necessary. If first-aid kits are stored under cover, the cover shall be marked by a symbol for first-aid kit according to Figure 8 of Annex 4, having a side length of at least 10 cm;
 - g) a pair of binoculars, 7 × 50 or with larger lens diameter;
 - h) a notice concerning the rescue and revival of persons overboard;
 - i) a searchlight that can be operated from the steering position.
4. There shall be an embarkation stairway or ladder on vessels whose side height above the unladen waterline exceeds 1,50 m.

Article 13.03 ***Portable fire extinguishers***

1. There shall be at least one portable fire extinguisher in accordance with the European Standards EN 3-7 : 2007 and EN 3-8 : 2021 at each of the following places:
- a) in the wheelhouse;
 - b) close to each entrance from the deck to accommodation spaces;
 - c) close to each entrance to service spaces which are not accessible from the accommodation spaces and which contain heating, cooking or refrigeration equipment using solid or liquid fuels or liquefied gas;
 - d) at each entrance to engine rooms and boiler rooms;
 - e) at suitable points below deck in engine rooms and boiler rooms such that no position in the space is more than 10 metres walking distance away from an extinguisher.
2. For the portable fire extinguishers required by (1), only powder type extinguishers with a content of at least 6 kg or other portable extinguishers with the same extinguishing capacity may be used. They shall be suitable for Class A, B and C fires.

By way of derogation on vessels with no liquefied gas installations, spray foam fire extinguishers using aqueous film-forming foam (AFFF) frost proof to - 20 °C are permissible even if they are unsuitable for Class C fires. These fire extinguishers shall have a minimum capacity of 9 litres.

In rooms where fires involving vegetable or animal oils and fats are likely to occur the Inspection body may require one or more portable fire extinguishers suitable for extinguishing Class F fires. Such portable fire extinguishers shall be entered in item 52 of the inland navigation vessel certificate.

All extinguishers shall be suitable to extinguish fires in electrical systems of up to 1000 V.

3. In addition powder, water or spray foam fire extinguishers may be used which are suitable at least for the class of fire most likely to occur in the room for which they are intended.
4. Portable fire extinguishers with CO₂ as the extinguishing agent may be used only for extinguishing fires in galleys and electrical installations. The content of these fire extinguishers shall be no more than 1 kg per 15 m³ of the room in which they are made available for use.

5. Portable fire extinguishers shall be checked at least every two years by a competent person. An inspection label shall be affixed to the fire extinguisher, signed by the competent person and showing the date of the inspection.
6. If portable fire extinguishers are installed in such a way that they are out of sight, the panel covering them shall be identified by a symbol for fire extinguishers as shown in Figure 3 of Annex 4, and having a side length of at least 10 cm.

Article 13.04

Permanently installed firefighting systems for protecting accommodation spaces, wheelhouses and passenger rooms

1. For protecting accommodation spaces, wheelhouses and passenger rooms, only suitable automatic pressurised water sprinkler systems are admitted as permanently installed fire-fighting systems.
2. Installation or conversion of the systems shall be carried out only by specialised firms.
3. The systems shall be made of steel or equivalent non-combustible materials.
4. The systems shall be able to spray water at a rate of at least 5 l/m² per minute over the area of the largest room to be protected.
5. Systems spraying smaller quantities of water shall have a type-approval pursuant to IMO Resolution A.800 (19)¹ or another Standard recognised by one of the Member States. Type-approval shall be carried out by a recognised classification society or an accredited testing institution. The accredited testing institution shall comply with the European Standard EN 17025 : 2017.
6. The systems shall be checked by an expert:
 - a) before being put into service for the first time;
 - b) before being put back into service after they have been triggered;
 - c) before being put back into service after any major modification or repair; and
 - d) regularly, at least every two years.

Inspections as referred to in (d) may also be carried out by a competent person from a competent firm specialising in fire extinguishing systems.

7. When carrying out the check in accordance with (6), the expert or competent person shall verify whether the systems meet the requirements of this Article.

The check shall at least include:

- a) external inspection of the entire system;
- b) functional testing of the safety systems and nozzles;
- c) functional testing of the pressure tanks and pumping system.

¹ IMO Resolution A.800 (19) adopted on 23 November 1995 - Revised Guidelines for Approval of Sprinkler Systems Equivalent to that referred to in SOLAS Regulation II-2/12.

8. An inspection attestation, signed by the expert or competent person, shall be issued, showing the date of inspection.
9. The number of installed systems shall be entered in the inland navigation vessel certificate.

Article 13.05

Permanently installed firefighting systems for protecting engine rooms, boiler rooms and pump rooms

1. Extinguishing agents

For protecting engine rooms, boiler rooms and pump rooms, the following extinguishing agents may be used in permanently installed fire-fighting systems:

- a) CO₂ (carbon dioxide);
- b) HFC 227 ea (heptafluoropropane);
- c) IG-541 (52 % nitrogen, 40 % argon, 8 % carbon dioxide);
- d) FK-5-1-12 (dodecafluoro-2-methylpentane-3-on);
- e) H₂O (Water);
- f) K₂CO₃ (potassium carbonate).

2. Ventilation, air intake

- a) Combustion air for the propulsion engines shall not be extracted from rooms that are to be protected by permanently installed fire-fighting systems. This shall not apply where there are two mutually independent and hermetically separated main engine rooms or if next to the main engine room there is a separate engine room with a bow thruster, ensuring that the vessel can continue to make steerageway under its own power in the event of fire in the main engine room.
- b) Any forced ventilation present in the room to be protected shall switch off automatically if the fire-fighting system is triggered.
- c) There shall be devices available with which all apertures which can allow air to enter or gas to escape from the room to be protected can be quickly closed. It shall be clearly recognisable whether they are open or closed.
- d) The air escaping from pressure relief valves in the compressed-air tanks installed in engine rooms shall be conveyed to the open air.
- e) Over- or under-pressure resulting from the inflow of extinguishing agent shall not destroy the components of the surrounding partitions of the room to be protected. It shall be possible for the pressure to equalise without danger.
- f) Protected rooms shall have a facility for extracting the extinguishing agent and the combustion gases. Such facilities shall be capable of being operated from positions outside the protected rooms and which must not be made inaccessible by a fire within such spaces. If there are permanently installed extractors, it shall not be possible for these to be switched on while the fire is being extinguished.

3. Fire alarm system

The room to be protected shall be monitored by means of an appropriate fire alarm system. The fire alarm shall be noticeable in the wheelhouse, the accommodation spaces and the room to be protected.

4. Piping system

- a) The extinguishing agent shall be conveyed to the room to be protected and distributed there by means of a fixed piping system. Inside the room to be protected the piping and associated fittings shall be made of steel. Tank connecting pipes and expansion joints shall be exempt from this provided the materials used have equivalent properties in case of fire. Pipes shall be both internally and externally protected against corrosion.
- b) Outlet nozzles shall be dimensioned and fitted such that the extinguishing agent is evenly distributed. In particular the extinguishing agent shall also be effective beneath the floor plates.

5. Triggering device

- a) Fire-fighting systems with automatic triggering shall not be permissible.
- b) It shall be possible to trigger the fire-fighting system from a suitable place outside the room to be protected.
- c) Triggering devices shall be so installed that they can be activated also in the event of a fire, and that the required quantity of extinguishing agent can still be provided in the space to be protected in the event of a fire or of damage caused by a fire or an explosion;

Non-mechanical triggering devices shall be powered from two different mutually independent power sources. These power sources shall be located outside the room to be protected. Control lines in the room to be protected shall be designed so as to remain functional for at least 30 minutes in the event of fire. This requirement shall be fulfilled in the case of electric wiring if it complies with the International Standard IEC 60331-21 : 1999.

If triggering devices are installed in such a way that they are out of sight the panel covering them shall be identified by the 'fire-fighting installation' symbol as shown in Figure 6 of Annex 4, having a side length of at least 10 cm, and the following text in red lettering on a white background:

'Feuerlöscheinrichtung
Installation d'extinction
Brandblusinstallatie
Fire-fighting installation'.

- d) If the fire-fighting system is intended for the protection of several rooms, the triggering devices for each room have to be separate and clearly identified.
- e) Next to each triggering device operating instructions in one of the languages of the Member States shall be posted up visibly and indelibly. They shall contain, in particular, instructions regarding:
 - aa) triggering of the fire-fighting system;
 - bb) the need for checking to ensure that all persons have left the room to be protected;
 - cc) action to be taken by the crew when the firefighting system is triggered and when accessing the protected room after triggering or flooding, in particular with regard to the possible presence of dangerous substances;
 - dd) action to be taken by the crew in the case of failure of the fire-fighting system.
- f) The operating instructions shall point out that before the fire-fighting system is triggered combustion engines drawing air from the room to be protected are to be shut down.

6. Warning system

- a) Permanently installed fire-fighting systems shall be provided with acoustic and optical warning systems.
- b) The warning system shall be set off automatically as soon as the fire-fighting system is first triggered. The warning signal shall sound for an appropriate time before the extinguishing agent is released and it shall not be possible to switch it off.
- c) Warning signals shall be clearly visible in the rooms to be protected and outside the accesses to them and clearly audible even under operating conditions producing the loudest inherent noise. They shall be clearly distinct from all other acoustic and optical signals in the room to be protected.
- d) The acoustic warning signals shall be clearly audible in the adjacent rooms even when connecting doors are closed and under operating conditions producing the loudest inherent noise.
- e) If the warning system is not self-monitoring as regards short-circuits, wire breaks and voltage drops, it shall be possible to check that it is working properly.
- f) At every entrance to a room that can be supplied with extinguishing agent, a clearly visible notice shall be put up bearing the following text in red lettering on a white background:

'Vorsicht, Feuerlöscheinrichtung!

Bei Ertönen des Warnsignals (Beschreibung des Signals) den Raum sofort verlassen!

Attention, installation d'extinction d'incendie !

Quitter immédiatement ce local au signal (description du signal) !

Let op, brandblusinstallatie!

Bij het in werking treden van het alarmsignaal (omschrijving van het signaal) deze ruimte onmiddellijk verlaten!

Warning, fire-fighting installation!

Leave the room as soon as the warning signal sounds (description of signal)!

7. Pressure tanks, fittings and pressure pipes

- a) Pressure tanks, fittings and pressure pipes shall comply with the requirements in force in one of the Member States or, if there are no such requirements, to those of a recognised classification society.
- b) Pressure tanks shall be installed in accordance with the manufacturer's instructions.
- c) Pressure tanks, fittings and pressure pipes are not to be installed in accommodation spaces.
- d) The temperature in cabinets and installation spaces containing pressure tanks shall not exceed 50 °C.
- e) Cabinets or installation spaces on deck shall be firmly fixed in place and have air vents which are to be arranged in such a way that in the event of a leak in the pressure tank no gas can escape into the interior of the vessel. Direct connections to other rooms are not permitted.

8. Quantity of extinguishing agent

If the quantity of extinguishing agent is intended for protecting more than one room, the total amount of extinguishing agent available does not need to be greater than the quantity necessary for the largest room to be protected.

9. Installation, inspection and documentation

- a) The system shall be installed or converted only by a firm specialising in fire-fighting systems. The requirements specified by the extinguishing agent manufacturer and the system manufacturer (product data sheet, safety data sheet) are to be complied with. Maintenance, in particular of the condition of the spray nozzles, shall be carried out regularly in accordance with the instructions of the system manufacturer or producer of the extinguishing agent (data sheet).
- b) The system shall be checked by an expert:
 - aa) before being put into service for the first time;
 - bb) before being put back into service after it has been triggered;
 - cc) before being put back into service after any major modification or repair; and
 - dd) regularly, at least every two years.Inspections as referred to in (dd) may also be carried out by a competent person from a competent firm specialising in fire extinguishing systems.
- c) In the inspection the expert or competent person shall check whether the system meets the requirements of this Article.
- d) The inspection shall cover at least the following:
 - aa) external inspection of the entire installation;
 - bb) tightness check on pipes;
 - cc) functional checking of control and triggering systems;
 - dd) checking of tank pressure and content;
 - ee) checking of tightness and facilities for locking the room to be protected;
 - ff) checking the fire alarm system;
 - gg) checking the warning system.
- e) An inspection attestation shall be issued, signed by the expert and showing the date of the inspection.
- f) The number of permanently installed fire-fighting systems shall be entered in the inland navigation vessel certificate.

10. CO₂ fire-fighting systems

Fire-fighting systems using CO₂ as the extinguishing agent shall comply with the following provisions in addition to the requirements under (1) to (9):

- a) CO₂ containers shall be housed outside the room to be protected in a space or cabinet hermetically separated from other rooms. The doors to these installation spaces and cabinets shall open outwards, be lockable and bear on the outside a symbol for 'General danger warning' in accordance with Figure 4 of Annex 4, at least 5 cm in height, together with the marking 'CO₂' in the same colour and with the same height.
- b) Installation spaces below decks for CO₂ containers shall be accessible only from the open air. These spaces shall have their own adequate artificial ventilation system with extraction ducts, completely separate from other ventilation systems on board.

- c) The CO₂ containers shall not be filled to more than 0,75 kg/l. The specific volume of unpressurised CO₂ gas is to be taken as 0,56 m³/kg.
- d) The volume of CO₂ for the room to be protected shall be at least 40 % of its gross volume. It shall be possible to supply this volume within 120 seconds. It shall be possible to check whether supply has been completed.
- e) Opening the container valves and operating the flood valve shall be by separate control operations.
- f) The appropriate time mentioned under (6)(b) shall be at least 20 seconds. There shall be a reliable device to ensure the delay before delivery of the CO₂ gas.

11. HFC-227ea — fire-fighting systems

Fire-fighting systems using HFC-227ea as the extinguishing agent shall comply with the following provisions in addition to the requirements under (1) to (9):

- a) If there are several rooms to be protected, each with a different gross volume, each room shall be provided with its own fire-fighting system.
- b) Each container of HFC-227ea that is installed in the room to be protected shall be equipped with a pressure relief valve. This shall harmlessly release the contents of the container into the room to be protected if the container is exposed to the effects of fire and the fire-fighting system has not been triggered.
- c) Each container shall be fitted with a device for checking the gas pressure.
- d) The containers shall not be filled to more than 1,15 kg/l. The specific volume of the unpressurised HFC-227ea is to be taken as 0,1374 m³/kg.
- e) The volume of HFC-227ea for the room to be protected shall be at least 8 % of the room's gross volume. This volume shall be supplied within 10 seconds.
- f) The HFC-227ea containers shall be provided with a pressure monitor which triggers an acoustic and optical alarm signal in the wheelhouse in the event of an unauthorised loss of propellant. If there is no wheelhouse, this alarm signal shall be given outside the room to be protected.
- g) After flooding, the concentration in the room to be protected shall not exceed 10,5 %.
- h) The fire-fighting system shall not contain any parts made of aluminium.

12. IG-541 — fire-fighting systems

Fire-fighting systems using IG-541 as the extinguishing agent shall comply with the following provisions in addition to the requirements under (1) to (9):

- a) If there are several rooms to be protected, each with a different gross volume, each room shall be provided with its own fire-fighting system.
- b) Each container of IG-541 that is installed in the room to be protected shall be equipped with a pressure relief valve. This shall harmlessly release the contents of the container into the room to be protected if the container is exposed to the effects of fire and the fire-fighting system has not been triggered.
- c) Each container shall be fitted with a device for checking the contents.

- d) the filling pressure of the container shall not exceed 200 bar at + 15 °C.
- e) the volume of IG-541 for the room to be protected shall be at least 44 % and no more than 50 % of the room's gross volume. This volume shall be supplied within 120 seconds.

13. FK-5-1-12 — firefighting systems

Firefighting systems using FK-5-1-12 as the extinguishing agent shall comply with the following provisions in addition to the requirements under (1) to (9):

- a) If there are several rooms to be protected, each with a different gross volume, each room shall be provided with its own firefighting system.
- b) Each container of FK-5-1-12 installed in the room to be protected shall be equipped with an overpressure relief valve. The pressure relief valve shall harmlessly release the contents of the container into the room to be protected if the container is exposed to the effects of fire and the fire-fighting system has not been triggered.
- c) Each container shall be fitted with a device for checking the gas pressure.
- d) The containers shall not be filled to more than 1,00 kg/l. The specific volume of the unpressurised FK-5-1-12 is to be taken as 0,0719 m³/kg.
- e) The volume of FK-5-1-12 for the room to be protected shall be at least 5,5 % of the room's gross volume. This volume shall be supplied within 10 seconds.
- f) The FK-5-1-12 containers shall be provided with a pressure monitor which triggers an acoustic and optical alarm signal in the wheelhouse in the event of an unauthorised loss of propellant. If there is no wheelhouse, this alarm signal shall be given outside the room to be protected.
- g) After flooding, the concentration in the room to be protected shall not exceed 10,0 %.

14. Fire-fighting systems using water as the extinguishing agent

Fire-fighting systems using water as the extinguishing agent may only release this agent into the room to be protected in the form of a water mist. The droplet size must be between 5 and 300 microns.

In addition to the requirements laid down in (1) to (7) and (9), (8) applies *mutatis mutandis*, these fire-fighting systems must comply with the following provisions:

- a) The fire-fighting system shall have a type-approval pursuant to MSC/Circ. 1165¹ or another Standard recognised by one of the Member States. Type-approval shall be carried out by a recognised classification society or an accredited testing institution. The accredited testing institution shall comply with the European Standard EN 17025 : 2017.
- b) The fire-fighting system must be sized according to the largest of the rooms to be protected and must be able to spray water continuously into the room for a minimum of 30 minutes.

¹ Circular MSC/Circ. 1165 – Revised guidelines for the approval of equivalent water-based fire-extinguishing systems for machinery spaces and cargo pump-rooms – adopted on 10 June 2005 and as amended by MSC/Circ.1269, MSC/Circ.1386 and MSC/Circ.1385.

- c) The pumps, their switching mechanisms and the valves that are required in order for the system to operate should be installed in a room outside the rooms to be protected. The room in which they are installed should be separated from adjacent by at least type A30 partition walls.
- d) The fire-fighting system must be completely full of water at all times at least as far as the trip valves and be under the required initial operating pressure. The water supply pumps must be automatically initiated when the system is triggered. The system must feature a continuously operating water supply. Measures must be taken to ensure impurities do not affect system operation.
- e) The capacity and design of the system's pipe network must be based on an hydraulic calculation.
- f) The number and arrangement of nozzles must ensure sufficient distribution of water in the rooms to be protected. The spray nozzles must be located so as to ensure that the water mist is distributed throughout the room to be protected, especially in those areas where there is a higher risk of fire, including behind the fittings and beneath the floor.
- g) The fire-fighting system's electrical components in the room to be protected must at a minimum comply with protection class IP54. The system shall feature two independent energy sources with automatic switching. One of the power sources must be located outside the room to be protected. Each power source should on its own be capable of ensuring the operation of the system.
- h) The fire-fighting system must feature redundant pumps.
- i) The fire-fighting system must be equipped with a monitoring device which triggers an alarm signal in the wheelhouse in the following cases:
 - drop in water tank level (if fitted),
 - power supply failure,
 - loss of pressure in the low pressure system pipework,
 - loss of pressure in the high pressure circuit,
 - when the system is activated.
- j) The documents required for the installation, functional testing and documentation of the installation referred to in (9) must include at a minimum:
 - a schematic diagram of the system showing the sections of pipe work and the types of spray nozzle,
 - the hydraulic calculation referred to in (d),
 - the manufacturer's technical documentation covering all aspects of the installation,
 - the maintenance manual.

15. K_2CO_3 - fire-fighting systems

In addition to the requirements laid down in (1) to (7) and (9), fire-fighting systems using K_2CO_3 as the extinguishing agent shall comply with the following provisions:

- a) The fire-fighting system shall have a type-approval pursuant to MSC/Circ. 1270¹ or another Standard recognised by one of the Member States. Type-approval shall be carried out by a recognised classification society or an accredited testing institution. The accredited testing institution shall comply with the European Standard EN 17025 : 2017.

¹ Circular MSC/Circ. 1270 – Revised Guidelines for the approval of fixed aerosol fire-extinguishing systems equivalent to fixed gas extinguishing systems, as referred to in SOLAS 1974, for machinery spaces – adopted on 4 June 2008. Circular MSC/Circ. 1270/Corr. 1 – Corrigendum – adopted on 29 August 2008.

- b) Each room shall be provided with its own firefighting system.
- c) The extinguishing agent must be stored in specially provided unpressurised tanks in the room to be protected. These tanks must be fitted in such a way that the extinguishing agent is dispensed evenly in the room. In particular the extinguishing agent must also work underneath the deck plates.
- d) Each tank is separately connected with the triggering device.
- e) The quantity of extinguishing agent relative to the room to be protected is at least 120 g per m³ of the net volume of this room. This net volume is calculated according to MSC/Circ. 1270, items 11.2 to 11.4. It shall be possible to supply the extinguishing agent within 120 seconds.

Article 13.06

Permanently installed firefighting systems for protecting objects

1. Permanently installed firefighting systems for protecting objects may be used to protect systems and equipment. In addition, rooms can also be protected with a firefighting system in accordance with this article, unless these rooms are subject to Articles 13.04 or 13.05 or are protected with firefighting systems in accordance with Articles 13.04 or 13.05.

The effect of the firefighting systems must be aimed directly at the objects to be protected. The operating area of the firefighting systems can be restricted by structural measures.

Firefighting systems for object protection can be already structurally integrated with the object in question.

With regard to their supply of extinguishing agent, permanently installed firefighting systems for protecting objects shall be independent of systems referred to in Articles 13.04 and 13.05 as well as (5) of this Article.

2. The following requirements of Article 13.05 apply to permanently installed firefighting systems for protecting objects:
 - a) (2) if the extinguishing agent used needs a restriction of the operating area by structural measures;
 - b) (3) and (4);
 - c) (5)(b) and (c), in addition to the provisions of (3) of this Article;
 - d) (6) (a) to (e), and, at every entrance to a room or in the near vicinity of an enclosed object, a clearly visible appropriate notice on the fire extinguishing system for objects shall be put up;
 - e) (7) to (13);
 - f) (14) (b) to (g), where one energy source is sufficient, and (i) and (j);
 - g) (15) (b) to (e).

Firefighting systems for protecting objects are only to use extinguishing agents that are appropriate to extinguishing a fire on or in the object to be protected and which are listed in Article 13.05(1).

The inspection body can authorise derogations in respect of the extinguishing agent for permanently installed firefighting systems for protecting objects that are based on a fire protection concept.

3. Permanently installed firefighting systems for protecting objects shall have the ability for manual triggering. Manual triggering shall be possible in the near vicinity of the protected object. They may be triggered automatically if the triggering signal is released by two fire detectors of different detection methods. The triggering shall occur without delay. If the fire-fighting system is intended for the protection of several objects, the triggering devices for each object have to be separate and clearly identified.

The triggering of the fire extinguishing system must be indicated in the wheelhouse and at the entrance to the room in which the object to be protected is located. In the case of enclosed objects, the indication at the entrance to the room may be omitted if the indicator is attached to the object itself.

For manual triggering, operating instructions in accordance with Article 13.05(5)(e) shall be posted up next to each triggering device, considering the location and nature of the object.

4. The type and location of permanently installed firefighting systems for protecting objects shall be entered in item 52 of the inland navigation vessel certificate.
5. The provisions of this Article do not apply to the water-spray systems in accordance with sections 9.3.1.28, 9.3.2.28 and 9.3.3.28 of the ADN.

Article 13.07 ***Ship's boats***

1. The following craft shall be equipped with a ship's boat according to European Standard EN 1914 : 2016:
 - a) motor cargo vessels, motor tankers and barges exceeding 150 t deadweight;
 - b) tugs and pushers with a water displacement of more than 150 m³;
 - c) floating equipment;
 - d) passenger vessels.
2. It shall be possible for one person to launch such ship's boats safely within five minutes from the first manual action necessary. If a powered launching device is used this shall be such that safe, quick launching shall not be impaired if its power supply fails.
3. Inflatable ship's boats shall be inspected according to manufacturer's instructions.

Article 13.08

Lifebuoys and lifejackets

1. On board craft there shall be at least three lifebuoys:
 - in accordance with European Standard EN 14144 : 2003; or
 - in accordance with the 1974 International Convention for the Safety of Life at Sea (SOLAS 1974), Chapter III, Regulation 7.1, and the International Life-Saving Appliance (LSA) Code, sub-section 2.1.

They shall be ready for use and attached to the deck at appropriate points without being attached to their mounting. At least one lifebuoy shall be in the immediate vicinity of the wheelhouse and shall be equipped with a self-igniting, battery-powered light that will not be extinguished in water.

2. A personal automatically inflatable life jacket shall be within reach of every person who is regularly on board a craft. Such life jackets shall conform to:
 - a) the Regulation (EU) 2016/425¹ as amended; or
 - b) the International Life-Saving Appliance (LSA) Code, sub-section 2.2.

The requirements of (a) above shall be deemed to have been met when the life jacket satisfies the European Standards EN ISO 12402-2 : 2020, EN ISO 12402-3 : 2020, EN ISO 12402-4 : 2020.

Non-inflatable lifejackets in accordance with (a) or (b) shall also be admissible for children.

3. Lifejackets shall be inspected in accordance with the manufacturer's instructions.

¹ Regulation (EU) 2016/425 of the European Parliament and of the Council of 9 March 2016 on individual protective equipment and abrogating Council Directive 89/686/EEC (OJ L81/51, 31.3.2016) or equivalent provisions of the Swiss Ordinance on the safety of personal protective equipment of 25 October 2017 (RS 930.115).

CHAPTER 14

SAFETY AT WORK STATIONS

Article 14.01

General

1. Vessels shall be built, arranged and equipped in such a way as to enable persons to work and move about in safety in passageways.
2. Permanently installed facilities that are necessary for working on board shall be arranged, laid out and secured in such a way as to permit safe and easy operation, use and maintenance. If necessary, mobile or high-temperature components shall be fitted with protective devices.

Article 14.02

Protection against falling

1. Decks and side decks shall be flat and at no point be likely to cause tripping; it shall be impossible for puddles to form.
2. Decks, side decks, engine room floors, landings, stairways and the tops of side deck bollards shall have non-slip surfaces.
3. The tops of side deck bollards and obstacles in passageways, such as the edges of steps, shall be painted in a colour contrasting with the surrounding deck.
4. The outer edges of decks and side decks, as well as work stations where persons might fall more than 1 m, shall be fitted with bulwarks or coamings that are at least 0,90 m high or with a continuous guard rail in accordance with European Standard EN 711 : 2016. Where the shipside guard rails are retractable,
 - a) a continuous handrail 0,02 to 0,04 m in diameter shall additionally be secured to the coaming at a height of 0,7 to 1,1 m; and
 - b) signs in accordance with Annex 4, Figure 10, at least 15 cm in diameter, shall be affixed in clearly visible positions at the point where the side deck begins.
5. By way of derogation from (4), in the case of lighters and barges without accommodation, bulwarks or guard rails shall not be required where:
 - a) foot rails have been fitted to the outer edges of the decks and side decks;
 - b) handrails in accordance with (4)(a) have been fitted to the coamings; and
 - c) signs in accordance with Annex 4, Figure 10, at least 15 cm in diameter, have been affixed in clearly visible positions on deck.
6. By way of derogation from (4), in the case of vessels with flush- or trunk-decks it shall not be required that guard rails be fitted directly on the outer edges of those decks, or on side decks where:
 - a) the passageways run over those decks;

- b) the passageways and work stations on those decks are surrounded by fixed guard rails in accordance with EN 711 : 2016; and
 - c) signs in accordance with Annex 4, Figure 10, at least 15 cm in diameter, have been affixed in clearly visible positions at the transitions to areas unprotected by guard rails.
7. At work stations where there is danger of falling more than 1 m the inspection body may require appropriate fittings and equipment to ensure safe working.

Article 14.03 ***Dimensions of work stations***

Work stations shall be large enough to provide every person working in them with adequate freedom of movement.

Article 14.04 ***Side decks***

1. The clear width of a side deck shall be at least 0,60 m. This requirement applies up to a height of 2,00 m above the side deck.

By way of derogation from the first sentence, the clear width of the side deck may be reduced to
 - a) 0,50 m at certain points that are necessary for the operation of the vessel such as deck-washing valves,
 - b) 0,40 m at bollards and cleats.
2. By way of derogation from (1), the clear width of the side deck may be reduced to 0,54 m, up to a height of 0,90 m above the side deck, provided that the clear width above, between the outer edge of the hull and the inner edge of the hold, is not less than 0,65 m.
3. By way of derogation from (1), the clear width of the side deck may be reduced to 0,50 m, provided that the outer edge of the side deck is fitted with a guard rail in accordance with European standard EN 711 : 2016 to prevent falling.

Article 14.05 ***Access to work stations***

1. Points of access and passageways for the movement of persons and objects shall be of sufficient size and so arranged that:
 - a) in front of the access opening, there is sufficient room not to impede movement;
 - b) the clear width of the passageway shall be appropriate for the intended use of the working space and shall be not less than 0,60 m, except in the case of craft less than 8 m wide, where it may be reduced to 0,50 m;
 - c) the clear height of the passageway including the sill is not less than 1,90 m.
2. Doors shall be so arranged that they can be opened and closed safely from either side. They shall be protected against accidental opening or closing.

3. Appropriate stairs, ladders or steps shall be installed in accesses, exits and passageways where there is more than a 0,50 m difference in floor level.
4. Work stations which are manned continuously shall be fitted with stairs if there is a difference in floor level of more than 1,00 m. This requirement shall not apply to emergency exits.
5. Vessels with holds shall have at least one permanently installed means of access at each end of each hold.

By way of derogation from the first sentence the permanently installed means of access may be dispensed with if at least two movable ladders are provided which reach at least 3 rungs over the hatch coaming at an angle of inclination of 60°.

Article 14.06 ***Exits and emergency exits***

1. The number, arrangement and dimensions of exits, including emergency exits, shall be in keeping with the purpose and dimensions of the relevant space. Where one of the exits is an emergency exit, it shall be clearly marked as such.
2. Emergency exits or windows or the covers of skylights to be used as emergency exits shall have a clear opening of not less than 0,36 m², and the smallest dimension shall be not less than 0,50 m.

Article 14.07 ***Ladders, steps and similar devices***

1. Stairs and ladders shall be securely fixed. Stairs shall be not less than 0,60 m wide and the clear width between handrails shall be not less than 0,60 m; steps shall be not less than 0,15 m deep; steps shall have non-slip surfaces and stairs with more than three steps shall be fitted with handrails.
2. Ladders and separately attached rungs shall have a clear width of not less than 0,30 m; rungs shall be not more than 0,30 m apart and the distance between rungs and structures shall be not less than 0,15 m.
3. Ladders and separately attached rungs shall be clearly recognisable from above and shall be equipped with safety handles above exit openings.
4. Movable ladders shall be at least 0,40 m wide, and at least 0,50 m wide at the base; it shall be possible to ensure that they will not topple or skid; the rungs shall be securely fixed in the uprights.

Article 14.08 ***Interior rooms***

1. The dimensions, arrangement and layout of interior work stations shall be in keeping with the work to be carried out and shall meet the health and safety requirements. They shall be equipped with sufficient non-dazzle lighting and with sufficient ventilation arrangements. If necessary, they shall be fitted with heating appliances capable of maintaining an adequate temperature.

2. The floors of interior working spaces shall be solid and durable, and shall be designed not to cause tripping or slipping. Openings in decks and floors shall, when open, be secured against the danger of falling. Windows and skylights shall be so arranged and fitted that they can be operated and cleaned safely.

Article 14.09
Protection against noise and vibration

1. Working spaces shall be so situated, equipped and designed that employees are not exposed to harmful vibrations.
2. Permanent working spaces shall, in addition, be so constructed and sound-proofed that the health and safety of employees are not affected by noise.
3. For persons who are likely to be exposed to noise levels exceeding 80 dB(A) every day, individual acoustic protection devices shall be available. In working spaces where the noise level can exceed 85 dB(A) it shall be indicated that wearing of acoustic protection devices is mandatory by a symbol 'Wear acoustic protection device' with a diameter of at least 10 cm in accordance with Figure 7 of Annex 4.

Article 14.10
Hatch covers

1. Hatch covers shall be easily accessible and safe to handle. Hatch-cover components weighing more than 40 kg shall be designed to slide or pivot or be fitted with mechanical opening devices. Hatch covers operated by lifting gear shall be fitted with adequate and easily accessible attachment devices. Non-interchangeable hatch covers and upper sills shall be clearly marked to show the hatches to which they belong and their correct position on those hatches.
2. Hatch covers shall be secured against being tilted by the wind or by loading gear. Sliding covers shall be fitted with catches to prevent accidental horizontal movement of more than 0,40 m; they shall be capable of being locked in their final position. Appropriate devices shall be fitted to hold stacked hatch covers in position.
3. The power supply for mechanically operated hatch covers shall be cut off automatically when the control switch is released.
4. Hatch covers shall be capable of bearing the loads to which they are likely to be subjected: Hatch covers designed to be walked on shall be capable of bearing concentrated loads of at least 75 kg. Hatch covers not designed to be walked on shall be marked as such. Hatch covers designed to receive deck cargo shall have the permissible load in t/m² marked on them. Where supports are needed to achieve the maximum permissible load this shall be indicated in an appropriate place; in this case the relevant drawings shall be kept on board.

Article 14.11
Winches

1. Winches shall be designed in such a way as to enable work to be carried out safely. They shall be fitted with devices that prevent unintentional load release. Winches that do not lock automatically shall be fitted with a brake that is adequate to deal with their tractive force.
2. Hand-operated winches shall be fitted with devices to prevent kickback of the crank. Winches that are both power- and manually driven shall be designed in such a way that the motive-power control cannot actuate the manual control.

Article 14.12
Cranes

1. Cranes shall be built in accordance with best practice. The forces arising during their operation shall be safely transmitted into the vessel's structure; they shall not impair its stability.
2. A manufacturer's plate containing the following information shall be affixed to cranes:
 - a) manufacturer's name and address;
 - b) the CE marking, together with the year of manufacture;
 - c) series or type reference;
 - d) where applicable, serial number.

3. The maximum permissible loadings shall be permanently marked in a clearly legible manner on cranes.

Where a crane's safe working load does not exceed 2000 kg, it will be sufficient if the safe working load at the maximum reach is permanently marked in a clearly legible manner on the crane.

4. The presence of devices to protect against crushing or shearing hazards is mandatory. The outer parts of the crane shall leave a minimum safety clearance of 0,50 m relative to fixed superstructure in workstations and passageways.
5. It shall be possible to protect power driven cranes against unauthorised use. It shall only be possible to start these up from the crane's driving position. The control shall be of the automatic-return type (buttons without stops); their operating direction shall be unambiguously clear.

If the motive power fails, it shall not be possible for the load to drop in an uncontrolled manner. Unintentional crane movements shall be prevented.

Any upward movement of the hoisting device and any exceeding of the safe working load shall be limited by an appropriate device. Any downward movement of the hoisting device shall be limited if under any envisaged operating conditions at the moment of attaching the hook there can be less than two cable windings on the drum. The corresponding counter movement shall still be possible after the automatic limiting devices have been actuated.

The breaking load of the cables for running rigging shall correspond to five times the cable's permissible loading. The cable construction shall be faultless and the design shall be suitable for use on cranes.

6. Cranes shall be inspected by an expert:
- a) before being put into service for the first time;
 - b) before being put back into service after any major modification or repair, and
 - c) regularly, at least every ten years.

In this inspection proof of adequate strength and stability shall be provided by calculations and an on-board load test.

Where a crane's safe working load does not exceed 2000 kg the expert may decide that the proof by calculation may be fully or partly replaced by a test with a load 1.25 times the safe working load carried out over the full working range.

An inspection attestation shall be issued, signed by the expert and showing the date of the inspection.

7. Cranes shall be checked regularly and in any case at least every year, by a competent person. During that inspection the safe working condition of the crane shall be determined by a visual check and an operating check.

An inspection attestation shall be issued, signed by the competent person and showing the date of the inspection.

8. Cranes with a safe working load exceeding 2000 kg, or which are used for transshipment of cargo, or which are mounted on board lifting jacks, pontoons and other floating equipment or worksite craft shall in addition meet the requirements of one of the Member States.

9. The crane manufacturer's operating instructions shall be kept on board. These shall include at least the following information:
- a) operating range and function of the controls;
 - b) maximum permissible safe working load as a function of the reach;
 - c) maximum permissible inclination of the crane;
 - d) assembly and maintenance instructions;
 - e) general technical data.

Article 14.13

Storing flammable liquids

To store flammable liquids with a flash point of less than 55 °C there shall be a ventilated cupboard made of non-combustible material on deck. On its outside there shall be a symbol 'Fire, naked flame and smoking prohibited' with a diameter of at least 10 cm in accordance with Figure 2 of Annex 4.

CHAPTER 15 ACCOMMODATION

Article 15.01 General

1. Vessels shall have accommodation for the persons lodging habitually on board, and at least for the minimum crew.
2. Accommodation shall be so designed, arranged and fitted out as to meet the health, safety and comfort needs of those on board. It shall be of safe and easy access and adequately insulated against heat and cold.
3. The inspection body may authorise exceptions to the provisions of this Chapter if the health and safety of those on board are ensured by other means.
4. The inspection body shall enter on the inland navigation vessel certificate any restrictions on the vessel's daily operating periods and its operating mode resulting from the exceptions referred to in (3).

Article 15.02 Special design requirements for accommodation

1. It shall be possible to ventilate accommodation adequately even when the doors are closed; in addition, communal living quarters shall receive adequate daylight and, as far as possible, provide a view out.
2. Where there is no deck-level access to the accommodation and the difference in level is 0,30 m or more the accommodation shall be accessible by means of stairs.
3. In the fore-section of the vessel no floor shall be more than 1,20 m below the plane of maximum draught.
4. Communal living quarters and sleeping cabins shall have at least two exits which are as far apart from each other as possible and which serve as escape routes. One exit may be designed as an emergency exit. This does not apply to rooms with an exit leading directly onto the deck or into a corridor which serves as an escape route, provided the corridor has two exits apart from each other leading to port and starboard. Emergency exits, which may include skylights and windows, shall have a clear opening of at least 0,36 m² and a shortest side no less than 0,50 m and permit rapid evacuation in an emergency. Insulation and cladding of escape routes shall be made of flame-retardant materials and the usability of escape routes shall be guaranteed at all times by appropriate means such as ladders or separately attached rungs.
5. Accommodation shall be protected against inadmissible noise and vibration. Sound pressure levels shall not exceed:
 - a) 70 dB(A) in communal living quarters;
 - b) 60 dB(A) in sleeping cabins. This provision shall not apply to vessels operating exclusively outside the rest periods of the crew as laid down by Member States' national regulations.

The restriction of the operating mode mentioned in (b) shall be entered on the inland navigation vessel certificate.

6. Headroom in the accommodation shall be not less than 2,00 m.
7. As a general rule, vessels shall have at least one communal living room partitioned off from the sleeping cabins.
8. The free floor area of communal living quarters shall be not less than 2 m² per person, and in any event not less than 8 m² in total (not counting furniture, except tables and chairs).
9. The cubic capacity of private living quarters and sleeping cabin shall be not less than 7 m³ each.
10. The volume of airspace per person shall be at least 3,5 m³ in private living quarters. In sleeping cabins it shall be at least 5 m³ for the first occupant and at least 3 m³ for each additional occupant (not counting volume of furniture). Sleeping cabins shall be intended for no more than two persons. Berths shall be not less than 0,30 m above the floor. Where one berth is placed over another, the headroom above each berth shall be not less than 0,60 m.
11. Doors
 - a) shall have an opening whose upper edge is at least 1,90 m above deck or above the floor and a clear width of at least 0,60 m. The prescribed height may be achieved by means of sliding or hinged covers or flaps;
 - b) shall be capable of being opened outwards from both sides;
 - c) which are located along escape routes shall not hinder the evacuation of persons when they are opened;
 - d) which are locked from the inside shall be capable of being opened from the outside in an emergency.

Sills shall not be more than 0,40 m high, but shall nonetheless comply with the provisions of other safety regulations.”
12. Stairways shall be permanently fixed and safely negotiable. They shall be deemed to be so when:
 - a) they are at least 0,60 m wide;
 - b) the tread is at least 0,15 m deep;
 - c) the steps are non-slip; and
 - d) stairways with more than three steps are fitted with at least one handrail or handle.
13. Pipes carrying dangerous gases or liquids, and particularly those under such a high pressure that a leak could pose a danger to persons, shall not be located in the accommodation or in corridors leading to the accommodation. This does not apply for the pipes of liquefied gas installations for domestic purposes, and to steam pipes and hydraulic system pipes, provided they are fitted in metal sleeves

Article 15.03

Sanitary installations

1. At least the following sanitary installations shall be provided in vessels with accommodation:
 - a) one toilet per accommodation unit or per six crew members. It shall be possible to ventilate these with fresh air;
 - b) one washbasin with waste pipe and connected up to hot and cold potable water per accommodation unit or per four crew members;
 - c) one shower or bath connected up to hot and cold potable water per accommodation unit or per six crew members.
2. The sanitary installations shall be in close proximity to the accommodation. Toilets shall not have direct access to galleys, mess rooms or combined communal living quarters/galleys.
3. Toilet compartments shall have a floor space of at least 1 m², not less than 0,75 m wide and not less than 1,10 m long. Toilet compartments in sleeping cabins for no more than two persons may be smaller. Where a toilet contains a wash basin and/or shower, the floor space shall be increased at least by the floor space occupied by the wash basin and/or shower (or bath).

Article 15.04

Galleys

1. Galleys may be combined with communal living quarters.
2. Galleys shall comprise:
 - a) a cooker;
 - b) a sink with waste connection;
 - c) a supply of potable water;
 - d) a refrigerator;
 - e) sufficient storage and working space as well as storage space for supplies.
3. The eating area of combined galleys/communal living quarters shall be large enough to accommodate the number of crew normally using it at the same time. Seats shall be not less than 0,60 m wide.

Article 15.05

Potable water installations

1. Vessels with accommodation shall have a potable water installation. The filler neck of the potable water tanks shall be fitted with a connecting piece in accordance with International Standard ISO 5620-1 : 1992 or equivalent standard recognised by one of the Member States. Potable water tank filling apertures and potable water hoses shall be marked as being intended exclusively for potable water. This requirement is deemed to be fulfilled if the requirements of the International Standard ISO 14726 : 2008 are met. Potable water filler necks shall be installed above the deck."

2. Potable water installations shall:
 - a) on their inner surfaces be made of a material which resists corrosion and poses no physiological danger;
 - b) be free of pipe sections where a regular flow of water is not guaranteed, and
 - c) be protected against excessive heating.
3. In addition to (2), potable water tanks shall:
 - a) have a capacity of at least 150 litres per person normally living on board, and at least per crew member;
 - b) have a suitable, lockable opening to enable the inside to be cleaned;
 - c) have a water level indicator;
 - d) have ventilation pipes which lead to the open air or are fitted with appropriate filters.
4. Potable water tanks shall not share walls with other tanks. Potable water pipes shall not pass through tanks containing other liquids. Connections are not permitted between the potable water supply system and other pipes. Pipes carrying gas or liquids other than potable water shall not pass through potable water tanks.
5. Potable water pressure vessels shall operate only on uncontaminated compressed air. Where it is produced by means of compressors, appropriate air filters and oil separators shall be installed directly in front of the pressure vessel unless the water and the air are separated by a diaphragm.

Article 15.06 ***Heating and ventilation***

1. It shall be possible to heat accommodation in accordance with its intended use. Heating installations shall be appropriate for the weather conditions which may arise.
2. It shall be possible to ventilate the communal living quarters and sleeping cabins adequately even when the doors are closed. Ventilation shall ensure adequate air circulation in all climatic conditions.
3. The accommodation shall be so designed and arranged as to prevent as far as possible the entry of foul air from other areas of the vessel such as engine rooms or holds; where forced-air ventilation is used, the intake vents shall be so placed as to satisfy the above requirements.

Article 15.07 ***Other accommodation installations***

1. Each crew member living on board shall have an individual berth and an individual clothes locker fitted with a lock. The internal measurements of the berth shall be not less than 2,00 m long and 0,90 m wide.
2. Suitable places for storing and drying work clothes shall be provided, but not in the sleeping quarters.

3. All accommodation areas shall be fitted with electric lighting. Additional lamps using gas or liquid fuel may only be used in communal living quarters. Lighting devices using liquid fuel shall be made of metal and shall burn only fuels with a flash point above 55 °C or commercial paraffin oil. They shall be placed or attached so as not to constitute a fire hazard.

CHAPTER 16

FUEL-FIRED HEATING, COOKING AND REFRIGERATING EQUIPMENT

Article 16.01

General

1. Heating, cooking and refrigeration equipment running on liquefied gas shall meet the requirements of Chapter 17.
2. Heating, cooking and refrigeration equipment, together with its accessories, shall be so designed and installed that it is not dangerous even in the event of overheating. It shall be so installed that it cannot overturn or be moved accidentally.
3. The equipment referred to in (2) shall not be installed in areas in which substances with a flash point below 55 °C are used or stored. No flues from these installations may pass through such areas.
4. The supply of air necessary for combustion shall be ensured.
5. Heating appliances shall be securely connected to flues, which shall be fitted with suitable cowls or devices affording protection against the wind. They shall be arranged in such a manner as to permit cleaning.

Article 16.02

Use of liquid fuels, oil-fired equipment

1. Heating, cooking and refrigeration equipment which uses liquid fuel may be operated only with fuels whose flash point is above 55 °C.
2. By way of derogation from (1), cooking appliances and heating and refrigeration appliances fitted with burners with wicks and running on commercial paraffin oil may be permitted in the accommodation and wheelhouse provided the capacity of the fuel tank does not exceed 12 litres.
3. Appliances fitted with burners with wicks shall be:
 - a) fitted with a metal fuel tank whose filling aperture may be locked and which has no soft-solder joints below the maximum filling level, and shall be designed and installed in such a way that the fuel tank cannot be opened or emptied accidentally;
 - b) capable of being lit without the aid of another liquid fuel; and
 - c) so installed as to ensure the safe evacuation of combustion gases.

Article 16.03

Vaporising oil burner stoves and atomising oil burner heating appliances

1. Vaporising oil burner stoves and atomising oil burner heating appliances shall be built in accordance with best practice.

2. Where a vaporising oil burner stove or an atomising oil burner heating appliance is installed in an engine room, the air supply to the heating appliance and the engines shall be so designed that the heating appliance and the engines can operate properly and safely independently of one another. Where necessary, there shall be a separate air supply. The equipment shall be installed in such a way that no flame from the burner can reach other parts of the engine room installations.

Article 16.04 ***Vaporising oil burner stoves***

1. It shall be possible to light vaporising oil burner stoves without the aid of another combustible liquid. They shall be fixed above a metal drip pan which encompasses all the fuel-carrying parts, whose sides are at least 20 mm high and which has a capacity of at least 2 litres.
2. For vaporising oil burner stoves installed in an engine room, the sides of the metal drip pan prescribed in (1) shall be at least 200 mm high. The lower edge of the vaporising burner shall be located above the edge of the drip pan. In addition, the upper edge of the drip pan shall extend at least 100 mm above the floor.
3. Vaporising oil burner stoves shall be fitted with a suitable regulator which, at all settings, ensures a virtually constant flow of fuel to the burner and which prevents any fuel leak should the flame go out. Regulators shall be considered suitable which function properly even when exposed to vibration and inclined up to 12° and which, in addition to a level-regulating float, have
 - a) a second float which closes off the fuel supply safely and reliably when the permitted level is exceeded, or
 - b) an overflow pipe, but only if the drip pan has sufficient capacity to accommodate at least the contents of the fuel tank.
4. Where the fuel tank of a vaporising oil burner stove is installed separately:
 - a) the drop between the tank and the burner feed may not exceed that laid down in the manufacturer's operating instructions;
 - b) it shall be so installed as to be protected from unacceptable heating;
 - c) it shall be possible to interrupt the fuel supply from the deck.
5. The flues of vaporising oil burner stoves shall be fitted with a device to prevent draught inversion.

Article 16.05 ***Atomising oil burner heating appliances***

Atomising oil burner heating appliances shall in particular meet the following requirements:

- a) adequate ventilation of the burner shall be ensured before the fuel is supplied;
- b) the fuel supply shall be regulated by a thermostat;
- c) the fuel shall be ignited by an electric device or by a pilot flame;

- d) a flame monitoring device shall cut off the fuel supply when the flame goes out;
- e) the main switch shall be placed at an easily accessible point outside the installation room.

Article 16.06 ***Forced-air heating appliances***

Forced-air heating appliances consisting of a combustion chamber around which the heating air is conducted under pressure to a distribution system or to a room shall meet the following requirements:

- a) If the fuel is atomised under pressure the combustion air shall be supplied by a blower;
- b) The combustion chamber shall be well ventilated before the burner can be lit. Ventilation may be considered complete when the combustion air blower continues to operate after the flame has gone out;
- c) The fuel supply shall be automatically cut off if:
 - the fire goes out;
 - the supply of combustion air is not sufficient;
 - the heated air exceeds a previously set temperature; or
 - the power supply of the safety devices fails;In the above cases the fuel supply shall not be re-established automatically after being cut off;
- d) It shall be possible to switch off the combustion air and heating air blowers from outside the room where the heating appliance is located;
- e) Where heating air is drawn from outside, the intake vents shall be located as far as possible above the deck. They shall be installed in such a manner that rain and spray water cannot enter;
- f) Heating air pipes shall be made of metal;
- g) It shall not be possible to close the heating air outlet apertures completely;
- h) It shall not be possible for any leaking fuel to reach the heating air pipes;
- i) It shall not be possible for forced-air heating appliances to draw their heating air from an engine room.

Article 16.07 ***Solid fuel heating***

1. Solid fuel heating appliances shall be placed on a metal plate with raised edges such that no burning fuel or hot cinders fall outside the plate.

This requirement does not apply to appliances installed in compartments built of non-combustible materials and intended solely to house boilers.

2. Solid fuel boilers shall be fitted with thermostatic controls to regulate the flow of combustion air.
3. A means by which cinders can be quickly doused shall be placed in the vicinity of each heating appliance.

CHAPTER 17

LIQUEFIED GAS INSTALLATIONS FOR DOMESTIC PURPOSES

Article 17.01 **General**

1. Liquefied gas installations consist essentially of a supply unit comprising one or more gas receptacles, and of one or more pressure regulators, a distribution system and a number of gas-consuming appliances.

Spare and empty receptacles not in the supply unit shall not be considered part of the installation. Article 17.05 shall apply to them *mutatis mutandis*.

2. Installations may be operated only with commercial propane.

Article 17.02 **Installations**

1. Liquefied gas installations shall be suitable throughout for use with propane and shall be built and installed in accordance with best practice.
2. Liquefied gas installations may be used only for domestic purposes in the accommodation and the wheelhouse, and for corresponding purposes on passenger vessels.
3. There may be a number of separate installations on board. A single installation shall not be used to serve accommodation areas separated by a hold or a fixed tank.
4. No part of a liquefied gas installation shall be located in the engine room.

Article 17.03 **Receptacles**

1. Only receptacles with an approved content of between 5 and 35 kg are permitted. In the case of passenger vessels, the inspection body may approve the use of receptacles with a larger content.
2. The receptacles must satisfy the current requirements in one of the Member States.

These receptacles shall bear the official stamp certifying that they have been accepted following the required tests.

Article 17.04 **Location and arrangement of supply units**

1. Supply units shall be installed on deck in a freestanding or wall cupboard located outside the accommodation in a position such that it does not interfere with movement on board. They shall not, however, be installed against the fore or aft bulwark. The cupboard may be a wall cupboard set into the superstructure provided that it is gastight and can only be opened from outside the superstructure. It shall be so located that the distribution pipes leading to the gas consumption points are as short as possible.

No more receptacles may be in operation simultaneously than are necessary for the functioning of the installation. Several receptacles may be connected only if a reversing coupler is used. Up to four receptacles may be connected per supply unit. The number of receptacles on board, including spare receptacles, shall not exceed six per installation.

Up to six receptacles may be connected on passenger vessels with galleys or canteens for passengers. The number of receptacles on board, including spare receptacles, shall not exceed nine per installation.

Pressure regulators, or in case of two-stage regulation the first pressure regulator, shall be fitted to a wall in the same cupboard as the receptacles.

2. Supply units shall be so installed that any leaking gas can escape from the cupboard into the open without any risk of it penetrating inside the vessel or coming into contact with a source of ignition.
3. Cupboards shall be constructed of flame-retardant materials and shall be sufficiently ventilated by apertures in the top and bottom. Receptacles shall be placed upright in the cupboards in such a way that they cannot overturn.
4. Cupboards shall be so built and placed that the temperature of the receptacles cannot exceed 50 °C.
5. The words 'Liquefied gas' and a 'Fire, naked flame and smoking prohibited' symbol at least 10 cm in diameter in accordance with Figure 2 of Annex 4 shall be affixed to the outer wall of the cupboard.

Article 17.05 ***Spare and empty receptacles***

Spare and empty receptacles not located in the supply unit shall be stored outside the accommodation and the wheelhouse in a cupboard built in accordance with Article 17.04.

Article 17.06 ***Pressure regulators***

1. Gas-consuming appliances may be connected to receptacles only through a distribution system fitted with one or more pressure regulators to bring the gas pressure down to the utilisation pressure. The pressure may be reduced in one or two stages. All pressure regulators shall be set permanently at a pressure determined in accordance with Article 17.07.
2. The final pressure regulators shall be either fitted with or immediately followed by a device to protect the pipe automatically against excess pressure in the event of a malfunctioning of the pressure regulator. It shall be ensured that in the event of a leak in the protection device any leaking gas can escape into the open without any risk of it penetrating inside the vessel or coming into contact with a source of ignition; if necessary, a special pipe shall be fitted for this purpose.
3. The protection devices and vents shall be protected against the entry of water.

Article 17.07
Pressure

1. Where two-stage regulating systems are used, the mean pressure shall be not more than 2,5 bar above atmospheric pressure.
2. The pressure at the outlet from the last pressure regulator shall be not more than 0,05 bar above atmospheric pressure, with a tolerance of 10 %.

Article 17.08
Piping and flexible tubes

1. Pipes shall consist of permanently installed steel or copper tubing.

However, pipes connecting with the receptacles shall be high-pressure flexible tubes or spiral tubes suitable for propane. Gas-consuming appliances may, if not permanently installed, be connected by means of suitable flexible tubes not more than 1 m long.
2. Pipes shall be able to withstand any stresses, in particular regarding corrosion and strength, which may occur under normal operating conditions on board and their characteristics and layout shall be such that they ensure a satisfactory flow of gas at the appropriate pressure to the gas-consuming appliances.
3. Pipes shall have as few joints as possible. Both pipes and joints shall be gastight and shall remain gastight despite any vibration or expansion to which they may be subjected.
4. Pipes shall be readily accessible, properly fixed and protected at every point where they might be subject to impact or friction, particularly where they pass through steel bulkheads or metal walls. The entire surface of steel pipes shall be treated against corrosion.
5. Flexible pipes and their joints shall be able to withstand any stresses which may occur under normal operating conditions on board. They shall be installed in such a way that they are free of tension, cannot be heated excessively and can be inspected over their entire length.

Article 17.09
Distribution system

1. It shall be possible to shut off the entire distribution system by means of a main valve which is at all times easily and rapidly accessible.
2. Each gas-consuming appliance shall be supplied by a separate branch of the distribution system, and each branch shall be controlled by a separate closing device.

3. Valves shall be fitted at points where they are protected from the weather and from impact.
4. An inspection connection shall be fitted after each pressure regulator. It shall be ensured using a closing device that in pressure tests the pressure regulator is not exposed to the test pressure.

Article 17.10
Gas-consuming appliances and their installation

1. The only appliances that may be installed are propane-consuming appliances approved in one of the Member States and equipped with devices that effectively prevent the escape of gas in the event of either the flame or the pilot light being extinguished.
2. Appliances shall be so placed and connected that they cannot overturn or be accidentally moved and any risk of accidental wrenching of the connecting pipes is avoided.
3. Heating and water-heating appliances and refrigerators shall be connected to a flue for evacuating combustion gases into the open air.
4. The installation of gas-consuming appliances in the wheelhouse is permitted only if the wheelhouse is so constructed that no leaking gas can escape into the lower parts of the craft, in particular through the penetrations for control lines to the engine room.
5. Gas-consuming appliances may be installed in sleeping quarters only if combustion is independent of ambient air in the quarters.
6. Gas-consuming appliances in which combustion depends on ambient air shall be installed in rooms which are sufficiently large.

Article 17.11
Ventilation and evacuation of combustion gases

1. In rooms containing gas-consuming appliances in which combustion depends on ambient air, fresh air shall be supplied and combustion gases evacuated by means of ventilation apertures of adequate dimensions, with a clear section of at least 150 cm² per aperture.
2. Ventilation apertures shall not have any closing device and shall not lead to sleeping quarters.
3. Evacuation devices shall be so designed as to ensure the safe evacuation of combustion gases. They shall be reliable in operation and made of non-combustible materials. Their operation shall not be affected by forced ventilation.

Article 17.12

Operating instructions

An operating instruction shall be affixed on board in a suitable place. It shall contain at least the following:

'The valves of receptacles not connected to the distribution system shall be closed, even if the receptacles are presumed empty';

'Flexible pipes shall be replaced as soon as their condition so requires';

'All gas-consuming appliances shall be connected or the corresponding connecting pipes shall be sealed'.

Article 17.13

Testing

Liquefied gas installations shall be checked by an expert, in order to verify whether the installation conforms to the requirements of this Chapter:

- a) before being put into service for the first time;
- b) before being put back into service after any major modification or repair; and
- c) on every renewal of the attestation referred to in Article 17.15.

An inspection attestation shall be issued, signed by the expert and showing the date of the inspection. A copy of the inspection attestation shall be submitted to the inspection body.

Article 17.14

Test conditions

Tests on the installation shall be carried out under the following conditions:

1. Medium-pressure pipes between the closing device, referred to in Article 17.09(4), of the first pressure regulator and the valves fitted before the final pressure regulator:
 - a) pressure test, carried out with air, an inert gas or a liquid at a pressure 20 bar above atmospheric pressure;
 - b) tightness test, carried out with air or an inert gas at a pressure 3,5 bar above atmospheric pressure.
2. Pipes at the service pressure between the closing device, referred to in Article 17.09(4), of the only pressure regulator or the final pressure regulator and the valves fitted before the gas-consuming appliances:

tightness test, carried out with air or an inert gas at a pressure of 1 bar above atmospheric pressure.
3. Pipes situated between the closing device, referred to in Article 17.09(4), of the only pressure regulator or the final pressure regulator and the controls of gas-consuming appliances:

tightness test at a pressure of 0,15 bar above atmospheric pressure.

4. In the tests referred to in (1)(b), (2) and (3), the pipes are deemed gastight if, after sufficient time to allow for equalisation with ambient temperature, no decrease in the test pressure is observed during a further 10 minute test period.
5. Receptacle connectors, pipe joints and other fittings subjected to the pressure in the receptacles, and joints between pressure regulators and the distribution pipe:
tightness test, carried out with a foaming substance, at the service pressure.
6. All gas-consuming appliances shall be brought into service at the nominal capacity and shall be tested for satisfactory and undisturbed combustion at different capacity settings.

Flame failure devices shall be checked to ensure that they operate satisfactorily.
7. After the test referred to in (6), it shall be verified for each gas-consuming appliance connected to a flue, whether, after five minutes' operation at the nominal capacity, with windows and doors closed and the ventilation devices in operation, any combustion gases are escaping into the room through the air intake.

If there is a more than momentary escape of such gases, the cause shall immediately be detected and remedied. The appliance shall not be approved for use until all defects have been eliminated.

Article 17.15 ***Attestation***

1. The inland navigation vessel certificate shall include an attestation to the effect that all liquefied gas installations conform to the requirements of this Chapter.
2. The attestation will be issued by the inspection body following the testing referred to in Article 17.13.
3. The attestation shall be valid for a period not exceeding three years. It may be renewed only after a further testing carried out in accordance with Article 17.13.

Exceptionally, where the owner of a vessel or his representative submits a reasoned request, the inspection body may extend the validity of the attestation for not more than three months without carrying out the testing referred to in Article 17.13. Such extension shall be entered in the inland navigation vessel certificate.

CHAPTER 18

ON-BOARD SEWAGE TREATMENT PLANTS

Article 18.00 **Definitions**

In this Chapter:

1. 'on-board sewage treatment plant': a sewage treatment plant of compact design for treating the quantities of domestic waste water accruing on board;
2. 'type-approval': the decision whereby the competent authority confirms that an on-board sewage treatment plant satisfies the technical requirements of Chapter 18;
3. 'special test': the procedure carried out in accordance with Article 18.10 whereby the competent authority ensures that the on-board sewage treatment plant operated in a craft satisfies the requirements of Chapter 18;
4. 'manufacturer': the person or body who is responsible to the competent authority for all aspects of the type-approval procedure and for ensuring conformity of production. This person or body does not have to be involved in all stages of the construction of the on-board sewage treatment plant. If the on-board sewage treatment plant is converted by modifications or retrofitting after its original manufacture for use on a craft for the purposes of the Chapter 18, the person or body having carried out the modifications or retrofitting is considered as the manufacturer;
5. 'information document': the document set out in Annex 7, Section II that lists the information to be supplied by an applicant;
6. 'information folder': the complete set of data, drawings, photographs or other documents supplied by the applicant to the technical service or the competent authority as prescribed in the information document;
7. 'information package': the information folder plus any test reports or other documents that the technical service or the competent authority have added to the information folder in the course of their duties;
8. 'type-approval certificate' the document drawn up in accordance with Annex 7, Section III with which the competent authority certifies the type-approval;
9. 'operation management manual': the manual written for the on-board sewage treatment plant in accordance with Article 18.11, showing all the on-board sewage treatment plant's components, and containing instructions on the operation and maintenance of the on-board sewage treatment plant;
10. 'manufacturer's guide to checking the components and parameters relevant to sewage treatment': the document compiled in accordance with Article 18.10(4) for the purpose of implementing the installation, performance and special tests;
11. 'domestic waste water': waste water from galleys, dining rooms, washrooms and laundries and water containing faecal matter;
12. 'sewage sludge': residues accruing from operation of a sewage treatment plant on board a craft.

Article 18.01 General provisions

1. This Chapter applies to all on-board sewage treatment plants which are installed on board of craft.
2. a) On-board sewage treatment plants shall comply with the following limit values during the type test:

Table 1: Limit values to be observed in operation in the outflow of the on-board sewage treatment plant (test plant) during the type test

Parameter	Concentration (Stage II)	Sample
Biochemical oxygen demand (BOD_5) ISO 5815-1 : 2019 and 5815-2 : 2003 ¹	20 mg/l	24h composite sample, homogenised
	25 mg/l	Random sample, homogenised
Chemical oxygen demand (COD) ² ISO 15705 : 2022 ¹	100 mg/l	24h composite sample, homogenised
	125 mg/l	Random sample, homogenised
Total organic carbon (TOC) EN 1484 : 2019 ¹	35 mg/l	24h composite sample, homogenised
	45 mg/l	Random sample, homogenised

- 1) Member States may implement equivalent procedures.
- 2) Instead of the chemical oxygen demand (COD) the total organic carbon (TOC) may also be referred to for the check.

- b) On-board sewage treatment plants shall comply with the following control values during operation:

Table 2: Control values to be observed in the outflow of the on-board sewage treatment plant during operation

Parameter	Concentration (Stage II)	Sample
Biochemical oxygen demand (BOD_5) ISO 5815-1 : 2019 and 5815-2 : 2003 ¹	25 mg/l	Random sample, homogenised
Chemical oxygen demand (COD) ² ISO 15705 : 2022 ¹	125 mg/l	Random sample, homogenised
Total organic carbon (TOC) EN 1484 : 2019 ¹	45 mg/l	Random sample, homogenised

- 1) Member States may implement equivalent procedures.
2) Instead of the chemical oxygen demand (COD) the total organic carbon (TOC) may also be referred to for the check.

3. Processes using products containing chlorine are not admissible.

It is equally inadmissible to dilute domestic waste water so as to reduce the specific load and thereby also enable disposal.

4. Adequate arrangements shall be made for storage, preservation (if necessary), and discharge of the sewage sludge. This shall also include a management plan for the sewage sludge.
5. For the purpose of discharging tasks pursuant to this Chapter, the competent authority may employ a technical service. The technical services responsible shall satisfy the European Standard EN 17025 : 2017, taking the following conditions into account:
- manufacturers of on-board sewage treatment plants cannot be recognised as technical services;
 - for the purposes of this Chapter a technical service may, with the agreement of the competent authority, make use of facilities external to its own laboratory.
6. Each on-board sewage treatment plant shall come with an operation management manual in compliance with Article 18.11. The operation management manual shall be carried on board.
7. The limit values set out in Table 1 in (2)(a) shall be confirmed by a type test and determined by a type-approval. The type-approval shall be certified in a type-approval certificate. The operation management manual and a copy of the type-approval certificate shall be submitted to the competent authority and the technical service upon request.
8. The on-board sewage treatment plant shall be designed in such a way that operating faults or the failure of the on-board sewage treatment plant do not result in untreated sewage being discharged into the waterway.

9. Each on-board sewage treatment plant shall have a sampling point (sampling tap).
10. The following data shall be entered in item 52 of the inland navigation vessel certificate for all on-board sewage treatment plants:
 - a) name of the manufacturer;
 - b) on-board sewage treatment plant type;
 - c) type-approval number;
 - d) serial number;
 - e) year of construction.
11. The on-board sewage treatment plant shall be serviced at regular intervals and in accordance with the manufacturer's instructions. Maintenance shall be documented in the operation management manual.

Article 18.02 ***Application for type-approval***

1. An application for type-approval for an on-board sewage treatment plant type shall be submitted by the manufacturer to the competent authority. The application shall enclose
 - a) an information folder in accordance with Article 18.00(6),
 - b) the draft of the operation management manual in accordance with Article 18.11, and
 - c) the manufacturer's guide to checking the components and parameters relevant to sewage treatment for that on-board sewage treatment plant type in accordance with Article 18.00(10).

For the type test the manufacturer shall demonstrate a prototype of the on-board sewage treatment plant.

2. If, in a particular application for type-approval for an on-board sewage treatment plant type, the competent authority finds that the application submitted with regard to the presented plant prototype is not representative of the characteristics of this type of on-board sewage treatment plant as described in Annex 7, Section II, Appendix 1 another, if necessary additional, prototype, to be designated by the competent authority, shall be supplied for approval in accordance with (1).
3. No application for type-approval for an on-board sewage treatment plant type may be submitted to more than one competent authority. A separate application shall be submitted for each on-board sewage treatment plant type to be approved.

Article 18.03 ***Type approval procedure***

1. The competent authority to which the application is submitted shall issue the type-approval for the on-board sewage treatment plant type which corresponds to the descriptions in the information folder and satisfies the requirements of this Chapter. The fulfilling of these requirements will be proven by a type test in accordance with Annex 7, Section IX.

2. For each on-board sewage treatment plant type that it type-approves, the competent authority shall complete all relevant parts of the type-approval certificate, the model for which is to be found in Annex 7, Section III, and shall compile or verify the contents of the index to the information package. Type approval certificates shall be numbered in accordance with the method described in Annex 7, Section IV. The completed type-approval certificate and its Annexes shall be delivered to the applicant.
3. If the on-board sewage treatment plant to be approved can only fulfil its function or only has specific properties in conjunction with other components of the craft in which it is to be installed and if for this reason compliance with one or more requirements can only be checked if the on-board sewage treatment plant to be approved is operated together with other real or simulated components of the craft, the scope of the type-approval for this on-board sewage treatment plant shall be limited accordingly. In such cases, all restrictions on use and all installation requirements shall be detailed in the type-approval certificate for that plant type.

Article 18.04 ***Amendment of type-approvals***

1. The competent authority which issued the type-approval shall make the necessary arrangements to ensure that it is informed of any change in the particulars appearing in the information package.
2. The application for amendment or extension of a type-approval shall be made exclusively to the competent authority which issued the original type-approval.
3. Should characteristics of the on-board sewage treatment plant as described in the information package have been modified, the competent authority shall:
 - a) issue revised pages of the information package as necessary, marking each revised page to show clearly the nature of the change and the date of re-issue. Whenever revised pages are issued, the index to the information package which is attached to the type-approval certificate shall also be updated accordingly;
 - b) issue a revised type-approval certificate (with an extension number) if any information on it (excluding its annexes) has changed or if the minimum requirements of this Chapter have changed since the original approval date. The revised type-approval certificate shall clearly show the reason for its modification and the date of the re-issueShould the competent authority which issued the type-approval find that new trials or tests are justified owing to a modification made to the information package, it shall notify the manufacturer of this fact and issue the documents specified above only after new trials or tests have been successfully completed

Article 18.05 ***Conformity of the type-approval***

1. The manufacturer shall affix to each on-board sewage treatment plant manufactured in conformity with the type-approval the markings as defined in Annex 7, Section I, including the type-approval number.
2. Should the type-approval contain limitations of usage in accordance with Article 18.03(3), the manufacturer shall enclose detailed information on these limitations and all installation requirements with each unit manufactured.

3. If requested by the competent authority which issued the type-approval, the manufacturer shall provide a list of the serial numbers of all on-board sewage treatment plants which have been manufactured in accordance with the requirements set out in this Chapter since the last report, or since the point at which these provisions first came into force, within 45 days after the end of each calendar year, and immediately after each additional date specified by the competent authority. The list shall set out the correlations between the serial numbers, the corresponding on-board sewage treatment plant types and the type-approval numbers. Furthermore, the list shall also include particular information for those cases where the manufacturer discontinues production of a type-approved on-board sewage treatment plant type. Should the competent authority not demand the regular provision of such a list from the manufacturer, the manufacturer shall retain the data recorded for a period of at least 40 years.

Article 18.06 ***Checking of serial numbers***

1. The competent authority issuing a type-approval shall ensure that the serial numbers of the on-board sewage treatment plants manufactured in conformity with the requirements of this Chapter are registered and checked. It may collaborate with other authorities as defined in this Chapter and with the competent authorities of the Member States.
2. An additional check of the serial numbers may take place in conjunction with the check on conformity of production with requirements laid down in Article 18.07.
3. In relation to the checking of the serial numbers, the manufacturer or their authorised representatives located in the Member States shall, if requested, promptly supply the competent authority with all necessary information relating to their direct purchasers as well as the serial numbers of those on-board sewage treatment plants which have been reported as manufactured in accordance with Article 18.05(3).
4. Should a manufacturer be unable to comply with the requirements set out in Article 18.05 when requested to do so by the competent authority, the approval for the on-board sewage treatment plant type concerned may be withdrawn. In such a case the notification procedure specified in Article 18.08(4) shall be used.

Article 18.07 ***Conformity of production***

1. The competent authority issuing a type-approval shall ascertain in advance that suitable arrangements have been made to ensure effective checking of conformity of production in respect of the requirements of Annex 7, Section I. It may collaborate with other authorities as defined in this Chapter and with the competent authorities of the Member States.
2. The competent authority which has issued a type-approval shall ascertain that the arrangements specified in (1) in respect of the provisions of Annex 7, Section I continue to be sufficient and that every on-board sewage treatment plant provided with a type-approval number in accordance with the requirements of this Chapter continues to correspond to the description in the type-approval certificate and its annexes for the type-approved on-board sewage treatment plant type. It may collaborate with other authorities as defined in this Chapter and with the competent authorities of the Member States.
3. The competent authority may recognise comparable tests carried out by other competent authorities as equivalent to the provisions of (1) and (2).

Article 18.08***Non-conformity with the type-approved on-board sewage treatment plant type***

1. Non-conformity with the type-approved on-board sewage treatment plant type shall be deemed to exist when there are deviations from the characteristics in the type-approval certificate or, as the case may be, from the information package which have not been approved in accordance with Article 18.04(3) by the competent authority which issued the type-approval.
2. Should the competent authority which has issued a type-approval find that on-board sewage treatment plants do not conform with the on-board sewage treatment plant type for which it issued the approval, it shall take the necessary measures to ensure that on-board sewage treatment plants in production again conform with the type-approved on-board sewage treatment plant type. The competent authority which found the non-conformity shall inform the other competent authorities of the measures taken, which may extend to withdrawal of the type-approval.
3. If a competent authority is able to demonstrate that on-board sewage treatment plants provided with a type-approval number do not conform with the type-approved on-board sewage treatment plant type, it may require the competent authority which issued the type-approval to have the on-board sewage treatment plant type that is in production checked for conformity with the type-approved on-board sewage treatment plant type. Such action shall be taken within six months of the date of the request.

Article 18.09***Installation and performance test***

1. After the sewage treatment plant has been installed on board an installation and performance test shall be carried out by before regular operation begins.
2. The installation and performance test shall include:
 - a) Checking whether all the intended components or component groups have been correctly installed in accordance with the type-approval certificate and with the manufacturer's guide to checking the components and parameters of the on-board treatment plant relevant to sewage treatment;
 - b) Checking the proper functioning of the sewage treatment plant aboard the vessel.
3. The performance test as per 2(b) shall also be conducted if the on-board treatment plant is temporarily taken out of operation or undergoes maintenance.
4. Each installation and performance test shall be certified by the competent authority in the operation management manual in the form of the model in Annex 7 section VIII. The performance test specified in (3) can be certified by a specialised firm.

Article 18.10***Random sample measurement / Special test***

1. No later than three months after the commissioning of the craft or, in the case of retrofitting of the on-board sewage treatment plant, after it has been installed and the appropriate installation and performance test has been carried out, the competent authority shall take a random sample during operation of the craft in order to check the values set out in Article 18.01(2), Table 2.

At irregular intervals the competent authority shall carry out functionality checks on the on-board sewage treatment plant by means of random sample measurements to check the values set out in Article 18.01(2), Table 2.

Should the competent authority find that the values of the random sample measurements do not conform with the values set out in Article 18.01(1), Table 2, it may demand:

- a) that the defects in the on-board sewage treatment plant be remedied so as to ensure that it runs properly;
- b) that the on-board sewage treatment plant be made to conform with the type-approval again; or
- c) that a special test be carried out in accordance with (3).

Once the non-conformities have been remedied and the on-board sewage treatment plant has been made to conform with the type-approval again, the competent authority may carry out new random sample measurements.

If the defects are not remedied or the conformity of the on-board sewage treatment plant with the specifications of the type-approval is not restored, the competent authority shall seal the on-board sewage treatment plant and inform the inspection body to make an entry to that effect in item 52 of the inland navigation vessel certificate.

2. The random samples shall be measured in accordance with the specifications of Article 18.01(2), Table 2.
3. Should the competent authority find any discrepancies in the on-board sewage treatment plant indicating a deviation from the type-approval, the competent authority shall carry out a special test to determine the present state of the on-board sewage treatment plant in relation to the components specified in the on-board sewage treatment plant parameters record, the calibration and the setting of the parameters of the on-board sewage treatment plant.

Should the competent authority come to the conclusion that the on-board sewage treatment plant is not in conformity with the type-approved on-board sewage treatment plant type, it may take the following actions:

- a) demand that
 - aa) the conformity of the on-board sewage treatment plant be restored; or
 - bb) the type-approval in accordance with Article 18.04 be amended accordingly; or
- b) order measurement in accordance with the test procedure as set out in Annex 7, Section IX.

If conformity is not restored or the type-approval is not amended accordingly, or if it becomes apparent from the measurements made in accordance with (b) that the limit values laid down in Article 18.01(2)(a), Table 1 are not complied with, the competent authority shall seal the on-board sewage treatment plant and inform the inspection body to make an entry to that effect in item 52 of the inland navigation vessel certificate.

4. The tests in accordance with (3) shall be carried out on the basis of the type-approval certificate and the manufacturer's guide to checking the components and parameters of the on-board sewage treatment plant relevant to sewage treatment. This guide, which shall be compiled by the manufacturer and approved by a competent authority, shall specify the treatment-relevant components as well as settings, dimensioning criteria and parameters to be applied in order to ensure that the values set out in Article 18.01(2), Tables 1 and 2 are continuously maintained. It shall include at least the following information:
 - a) a specification of the on-board sewage treatment plant type with a process description and an indication of whether waste-water storage tanks are to be installed upstream of the on-board sewage treatment plant;
 - b) a list of the components specific to sewage treatment;
 - c) a schematic representation of the on-board sewage treatment plant with identifying features of the approved treatment-relevant components (e.g. part numbers on the components).
5. An on-board sewage treatment plant that has been sealed in accordance with (3) 3rd sentence may be brought back into service only after a special test in accordance with (3), first subparagraph.

Article 18.11 ***Operation management manual and instructions***

1. Each on-board sewage treatment plant shall have an operation management manual. The operation management manual shall be produced by the manufacturer of the sewage treatment plant installed on-board.
2. The operation management manual shall contain:
 - a) On-board sewage treatment plant components relevant to its operation according to Article 18.10(4),
 - b) Operating instructions:
 - aa) for both manual and automated operation of the on-board sewage treatment plant,
 - bb) for standby operation of the on-board sewage treatment plants,
 - cc) for emergency operation of the on-board sewage treatment plant,
 - dd) on the run-down, standstill and restart operation of the on-board sewage treatment plant,
 - ee) for the special treatment of greasy wastewater and galley waste water,
 - ff) for ongoing inspection and regular maintenance activities during operation as well as fuel supply,
 - gg) for sludge management (determining the sludge content, altering the sludge content),
 - c) Instructions and proofs regarding maintenance and repair,
 - d) Documentation templates,
 - aa) for documenting ongoing and regular inspection and maintenance activities and
 - bb) for documenting excess quantities of sludge and the depositing thereof.

PART III SPECIAL PROVISIONS

CHAPTER 19 SPECIAL PROVISIONS APPLICABLE TO PASSENGER VESSELS

Article 19.01 General provisions

1. The following provisions shall not apply:
 - a) Article 3.02(1)(b);
 - b) Article 4.01 and 4.02;
 - c) Article 8.08(2), second sentence, and (7);
 - d) Article 10.14(3), second sentence, for rated voltages of over 50 V;
 - e) Article 15.02(4).

2. The following items of equipment are prohibited on passenger vessels:
 - a) lamps powered by liquefied gas or liquid fuel according to Article 15.07(3) 2nd sentence;
 - b) devices fitted with wick burners according to Article 16.02(2) and (3),
 - c) vaporising oil-burner stoves according to Article 16.04;
 - d) solid fuel heating appliances and boilers according to 16.07;
 - e) liquefied gas installations according to Chapter 17.

3. Vessels without their own power cannot be licensed for passenger transport.

4. On passenger vessels, areas shall be provided for use by persons with reduced mobility, according to the provisions of this Chapter.

The number of seats for persons with reduced mobility cannot be less than 1 % (rounded up to the nearest whole number) of the permitted number of passengers. In addition, the number of cabins for persons with reduced mobility cannot be less than

 - a) one for cabin vessels with sleeping berths for a maximum of 200 passengers
 - b) two for cabin vessels with sleeping berths for more than 200 passengers.

5. By way of derogation from Article 7.02(2) first sentence, the area of obstructed vision for the helmsman ahead of the vessel in an unladen state with half of its supplies but without ballast shall not exceed two vessel lengths or 250 m, whichever is less.

6. By way of derogation from Article 7.02(3) third subparagraph, a passenger vessel shall be equipped with appropriate auxiliary means when no sufficiently unobstructed view is provided towards the rear. If these auxiliary means do not allow unobstructed view at night, a corresponding restriction shall be entered in item 52 of the inland navigation vessel certificate.

Article 19.02

Hull

- 1 In the course of the periodical inspections, the thickness of the outside plating of steel passenger vessels shall be determined as follows:
- a) the minimum thickness t_{min} of the bottom, bilge and side plating of the outer hull of passenger vessels is determined in accordance with the larger value of the following formulae:

$$t_{1_{min}} = 0,006 \cdot a \cdot \sqrt{T} [mm];$$

$$t_{2_{min}} = f \cdot 0,55 \cdot \sqrt{L_F} [mm].$$

In these formulae:

$$f = 1 + 0,0013 \cdot (a - 500);$$

a = longitudinal or transverse frame spacing (mm), and where the frame spacing is less than 400 mm, $a = 400$ mm should be entered;

- b) it is permissible to fall short of the minimum value determined in accordance with (a) above for the plate thickness in cases where the permitted value has been determined and certified on the basis of a mathematical proof for the sufficient strength (longitudinal, transverse and local) of the vessel's hull;
- c) at no point of the outside plating shall the thickness calculated in accordance with (a) or (b) above be less than 3 mm;
- d) plate renewals shall be carried out when bottom, bilge or side plate thicknesses have fallen short of the minimum value determined in accordance with (a) or (b), in conjunction with (c) above.
- 1a. Where materials other than steel, such as aluminium alloy or Fibre Reinforced Plastic composites, are being used for the construction of a passenger vessel, the structural components, such as bulkheads, walls, decks, ceilings and pillars, shall maintain load-carrying capabilities
- a) in spaces of major or high fire risk, up to the end of a standard one hour fire test,
- b) in spaces of moderate fire risk, up to the end of a standard half-hour fire test, and
- c) of supporting structure of rooms or areas protected for functional need, up to the end of a standard half-hour fire test.

In addition, the material of structural components shall be non combustible or fire-restricting.

The requirements relating to load-carrying capabilities of the structural components shall be deemed to be fulfilled if a certificate, either for the structural components or for the insulation protecting these components, is established in accordance with Article 19.11(1)(a), (d) and (e).

2. The number and position of bulkheads shall be selected such that, in the event of flooding, the vessel remains buoyant according to Article 19.03(7) to (13). Every portion of the internal structure which affects the efficiency of the subdivision of such vessels shall be watertight, and shall be of a design which will maintain the integrity of the subdivision.
3. For determining the positioning of the collision bulkhead and aft-peak bulkhead, the provisions of Article 3.03(1) shall apply, but the reference value to be used shall be the length of waterline L_{WL} rather than the length.

4. A transverse bulkhead may be fitted with a bulkhead recess, if all parts of this recess lie within the safe area.
5. The bulkheads, which are taken into account in the damage stability calculation according to Article 19.03(7) to (13), shall be watertight and be installed up to the bulkhead deck. Where there is no bulkhead deck, these bulkheads shall extend to a height at least 0,20 m above the margin line.
6. The number of openings in these bulkheads shall be kept as low as is consistent with the type of construction and normal operation of the vessel. Openings and penetrations shall not have a detrimental effect on the watertight function of the bulkheads.
7. Collision bulkheads shall have no openings and no doors.
8. Bulkheads separating the engine rooms from passenger rooms or crew and shipboard personnel accommodation shall have no doors.
9. Manually operated doors without remote control in bulkheads referred to in (5), are permitted only in areas not accessible to passengers. They shall:
 - a) remain closed at all times and be opened only temporarily to allow access;
 - b) be fitted with suitable devices to enable them to be closed quickly and safely;
 - c) display the following notice on both sides of the doors:

‘Close door immediately after passing through’.
10. Doors in bulkheads referred to in (5) that are open for long periods shall comply with the following requirements:
 - a) they shall be capable of being closed from both sides of the bulkhead and from an easily accessible point above the bulkhead deck;
 - b) after being closed by remote control the door shall be such that it can be opened again locally and closed safely. Closure shall not be impeded by carpeting, foot rails or other obstructions;
 - c) the time taken for the remote-controlled closure process shall be at least 30 seconds but not more than 60 seconds;
 - d) during the closure procedure an acoustic alarm shall automatically sound by the door; at least in areas intended for use by persons with reduced mobility, the alarm system must generate an optical and acoustic signal;
 - e) the door drive and alarm shall also be capable of operating independently of the on-board power supply. There shall be a device at the location of the remote control that displays whether the door is open or closed.
11. Doors in bulkheads referred to in (5), and their actuators shall be located in the safe area.
12. There shall be a warning system in the wheelhouse to indicate which of the doors in bulkheads referred to in (5) are open.
13. Open-ended piping and ventilation ducts shall be offset in such a way that, in any conceivable flooding, no additional spaces or tanks are flooded through them.
 - a) If several compartments are openly connected by piping or ventilation ducts, such piping and ducts shall, in an appropriate place, be lead above the damaged waterline corresponding to the worst possible flooding.

- b) Piping need not meet the requirement under (a) if shut-off devices are fitted in the piping where it passes through the bulkheads and which can be remotely controlled from a point above the bulkhead deck.
 - c) Where a pipework system has no open outlet in a compartment, the pipework shall be regarded as intact in the event of this compartment being damaged, if it runs within the safe area and is more than 0,50 m from the bottom of the vessel.
14. Remote controls of bulkhead doors according to (10) and shut-off devices according to (13)(b) above the bulkhead deck shall be clearly indicated as such.
15. Where double bottoms are fitted, their height shall be at least 0,60 m, and where double sides are fitted, their width shall be at least 0,60 m.
16. Windows may be situated below the margin line if they are watertight, cannot be opened, possess sufficient strength and conform to Article 19.06(14).

Article 19.03 **Stability**

1. The applicant shall prove by a calculation for the loading conditions as given in Article 19.03(2) that the intact stability of the vessel is appropriate. Proof of sufficient stability shall be approved by the inspection body. All calculations shall be carried out free to trim and sinkage. The basic values for the stability calculation – the vessel's lightweight and location of the centre of gravity – shall be determined
- a) by means of a heeling test in accordance with Annex 1 of IMO Resolution MSC.267(85)¹ (including special considerations for passenger vessels of less than 24 m in length) or
 - b) by detailed mass and moment calculation. In the latter case the lightweight of the vessel shall be checked by means of a lightweight test with a tolerance limit of $\pm 5\%$ between the mass determined by calculation and the displacement determined by the draught readings. However, in case of doubt on the accuracy on the mass calculation, the Inspection body may require a heeling test in accordance with (a).
2. The intact stability shall be proven for the following standard loading conditions:
- a) at the start of the voyage:
100 % passengers, 98 % fuel and fresh water, 10 % waste water;
 - b) during the voyage:
100 % passengers, 50 % fuel and fresh water, 50 % waste water;
 - c) at the end of the voyage:
100 % passengers, 10 % fuel and fresh water, 98 % waste water;
 - d) unladen vessel:
no passengers, 10 % fuel and fresh water, no waste water;
 - e) at the plane of maximum draught.

¹ MSC.267(85) adopted on 4 December 2008 – International Code on Intact Stability.

For all standard loading conditions, the ballast tanks shall be considered as either empty or full in accordance with normal operational conditions.

In addition, the requirement of section 3(d) shall be proved for the following loading condition:

100 % passengers, 50 % fuel and fresh water, 50 % waste water, all other liquid (including ballast) tanks are considered filled to 50 %.

3. The proof of adequate intact stability by means of a calculation shall be produced using the following definitions for the intact stability and for the standard loading conditions mentioned in (2)(a) to (d):
- the maximum righting lever h_{max} shall occur at a heeling angle of $\varphi_{max} \geq (\varphi_{mom} + 3^\circ)$ and shall not be less than 0,20 m. However, in case $\varphi_f < \varphi_{max}$ the righting lever at the downflooding angle φ_f shall not be less than 0,20 m;
 - the downflooding angle φ_f shall not be less than $(\varphi_{mom} + 3^\circ)$;
 - the area A under the curve of the righting levers shall, depending on the position of φ_f and φ_{max} , reach at least the following values:

Case			A
1	$\varphi_{max} \leq 15^\circ$ or $\varphi_f \leq 15^\circ$		0,05 m · rad up to the smaller of the angles φ_{max} or φ_f
2	$15^\circ < \varphi_{max} < 30^\circ$	$\varphi_{max} \leq \varphi_f$	0,035 + 0,001 · (30 – φ_{max}) m · rad up to the angle φ_{max}
3	$15^\circ < \varphi_f < 30^\circ$	$\varphi_{max} > \varphi_f$	0,035 + 0,001 · (30 – φ_f) m · rad up to the angle φ_f
4	$\varphi_{max} \geq 30^\circ$ and $\varphi_f \geq 30^\circ$		0,035 m · rad up to the angle $\varphi = 30^\circ$

Where:

h_{max} is the maximum lever;

φ the heeling angle;

φ_f the downflooding angle, that is the heeling angle, at which openings in the hull, in the superstructure or deck houses which cannot be closed so as to be watertight, submerge;

φ_{mom} the maximum heeling angle according to (e);

φ_{max} the heeling angle at which the maximum righting lever occurs;

A the area under the curve of the righting levers;

- the initial metacentric height, GM_o , corrected by the free surface effect in liquid tanks, shall not be less than 0,15 m;
- in each of the following two cases the heeling angle φ_{mom} shall not exceed 12° :
 - in application of the heeling moment due to persons and wind according to sections 4 and 5;
 - in application of the heeling moment due to persons and turning according to sections 4 and 6.

4. The heeling moment due to one-sided accumulation of persons M_p shall be calculated according to the following formula:

$$M_p = g \cdot P \cdot y = g \cdot \sum P_i \cdot y_i \text{ [kNm]}$$

P = total mass of persons on board in [t], calculated by adding up the maximum permitted number of passengers and the maximum number of shipboard personnel and crew under normal operating conditions, assuming an average mass per person of 0,075 t;

y = lateral distance of centre of gravity of total mass of persons P from centre line in [m];

g = acceleration of gravity ($g = 9,81 \text{ m/s}^2$);

P_i = mass of persons accumulated on area A_i ;

$$P_i = n_i \cdot 0,075 \cdot A_i \text{ [t]}$$

where

A_i = area occupied by persons in [m²];

n_i = number of persons per square meter:

$n_i = 3,75$ for free deck areas and deck areas with movable furniture; for deck areas with fixed seating furniture such as benches, n_i shall be calculated by assuming an area of 0,50 m in width and 0,75 m in seat depth per person;

y_i = lateral distance of geometrical centre of area A_i from centre line in [m].

The calculation shall be carried out for an accumulation of persons both to starboard and to port.

The distribution of persons shall correspond to the most unfavourable one from the point of view of stability. Cabins shall be assumed unoccupied for the calculation of the persons' moment.

For the calculation of the loading cases, the centre of gravity of a person shall be taken as 1 m above the lowest point of the deck at $0,5 L_{WL}$, ignoring any deck curvature and assuming a mass of 0,075 t per person.

A detailed calculation of deck areas which are occupied by persons may be dispensed with if the following values are used:

$P = 1,1 \cdot F_{max} \cdot 0,075$ for day trip vessels

$1,5 \cdot F_{max} \cdot 0,075$ for cabin vessels

where

F_{max} = maximum permitted number of passengers on board

$y = B/2$ in [m].

5. The heeling moment due to wind pressure M_w shall be calculated as follows:

$$M_w = p_w \cdot A_w \cdot \left(L_w + \frac{T}{2} \right) [kNm]$$

where:

p_w = the specific wind pressure of 0,25 kN/m²;

A_w = lateral plane of the vessel above the plane of draught according to the considered loading condition in [m²];

l_w = distance of the centre of gravity of the lateral plane A_w from the plane of draught according to the considered loading condition in [m].

In calculating the lateral plane, account shall be taken of the intended enclosure of the deck by awnings and similar mobile installations.

6. The moment due to centrifugal force M_{dr} , caused by the turning of the vessel, shall be calculated as follows:

$$M_{dr} = c_{dr} \cdot C_B \cdot v^2 \cdot \frac{\Delta}{L_{WL}} \cdot \left(KG - \frac{T}{2} \right) [kNm]$$

where

C_{dr} = a coefficient of 0,45;

C_B = block coefficient (if not known, taken as 1,0);

v = maximum speed of the vessel in [m/s];

The value must not exceed $v = 0,4 \sqrt{gL}$;

Δ = the total weight of the vessel, inclusive of cargo, in t;

KG = distance between the centre of gravity and the keel line in [m];

g = acceleration due to gravity (9,81 ms⁻²).

For passenger vessels with propulsion systems according to Article 6.06, M_{dr} shall be derived from full-scale or model tests or else from corresponding calculations.

If the passenger vessel is capable of achieving greater speeds than $v = 0,4 \sqrt{gL}$, the turning stability for these higher speeds is to be additionally derived from full-scale model tests or else from corresponding calculations.

7. The applicant shall prove by a calculation that the damage stability of the vessel is appropriate. The calculation of the final state of flooding should be based on the method of "lost buoyancy" and the interim states of flooding should be calculated on the basis of the method of "added mass". All calculations shall be carried out free to trim and sinkage.
8. Buoyancy of the vessel in the event of flooding shall be proven for the standard loading conditions specified in (2). Accordingly, mathematical proof of sufficient stability shall be determined for the three intermediate stages of flooding (25, 50 and 75 % of flood build-up) and for the final stage of flooding.

9. Passenger vessels shall comply with the one-compartment status and the two-compartment status.

The following assumptions concerning the extent of damage shall be taken into account in the event of flooding:

	1-compartment status	2-compartment status
Extent of the side damage		
longitudinal l [m]	$0,10 \cdot L_{WL}$, however not less than 4,00 m	$0,05 \cdot L_{WL}$, however not less than 2,25 m
transverse b [m]	B/5	0,59
vertical h [m]	from vessel bottom to top without delimitation	
Extent of the bottom damage		
longitudinal l [m]	$0,10 \cdot L_{WL}$, however not less than 4,00 m	$0,05 \cdot L_{WL}$, however not less than 2,25 m
transverse b [m]	B/5	
vertical h [m]	0,59; pipework installed according to Article 19.02(13)(c), shall be deemed intact	

- a) For 1-compartment status the bulkheads can be assumed to be intact if the distance between two adjacent bulkheads is greater than the damage length. Longitudinal bulkheads at a distance of less than B/3 to the hull, measured perpendicular to the centre line from the shell plating at the maximum draft shall not be taken into account for calculation purposes. A bulkhead recess in a transverse bulkhead that is longer than 2,50 m, is considered a longitudinal bulkhead.
- b) For 2-compartment status each bulkhead within the extent of damage will be assumed to be damaged. This means that the position of the bulkheads shall be selected in such a way as to ensure that the passenger vessel remains buoyant after flooding of two or more adjacent compartments in the longitudinal direction.
- c) The lowest point of every non-watertight opening (e.g. doors, windows, access hatchways) shall lie at least 0,10 m above the damaged waterline. The bulkhead deck shall not be immersed in the final stage of flooding.
- d) Permeability is assumed to be 95 %. If it is proven by a calculation that the average permeability of any compartment is less than 95 %, the calculated value can be used instead.

The values to be adopted shall not be less than:

Lounges	95 %
Engine and boiler rooms	85 %
Luggage and store rooms	75 %
Double bottoms, fuel bunkers, ballast and other tanks, depending on whether, according to their intended purpose, they are to be assumed to be full or empty for the vessel floating at the plane of maximum draught	0 % or 95 %

- e) If damage of a smaller dimension than specified above produces more detrimental effects with respect to heeling or loss of metacentric height, such damage shall be taken into account for calculation purposes.

10. For all intermediate stages of flooding referred to in (8), the following criteria shall be met:
- The heeling angle φ at the equilibrium position of the intermediate stage in question shall not exceed 15° .
 - Beyond the heel in the equilibrium position of the intermediate stage in question, the positive part of the righting lever curve shall display a righting lever value of $GZ \geq 0,02 \text{ m}$ before the first unprotected opening becomes immersed or a heeling angle φ of 25° is reached.
 - Non-watertight openings shall not be immersed before the heel in the equilibrium position of the intermediate stage in question has been reached.
 - The calculation of the free surface effect in all intermediate stages of flooding shall be based on the gross surface area of the damaged compartments.
11. During the final stage of flooding, the following criteria shall be met taking into account the heeling moment in accordance with (4):
- The heeling angle φ_E shall not exceed 10° .
 - Beyond the equilibrium position the positive part of the righting lever curve shall display a righting lever value of $GZ_R \geq 0,02 \text{ m}$ with an area $A \geq 0,0025 \text{ m} \cdot \text{rad}$. These minimum values for stability shall be met until the immersion of the first unprotected opening or in any case before reaching a heeling angle of 25° .

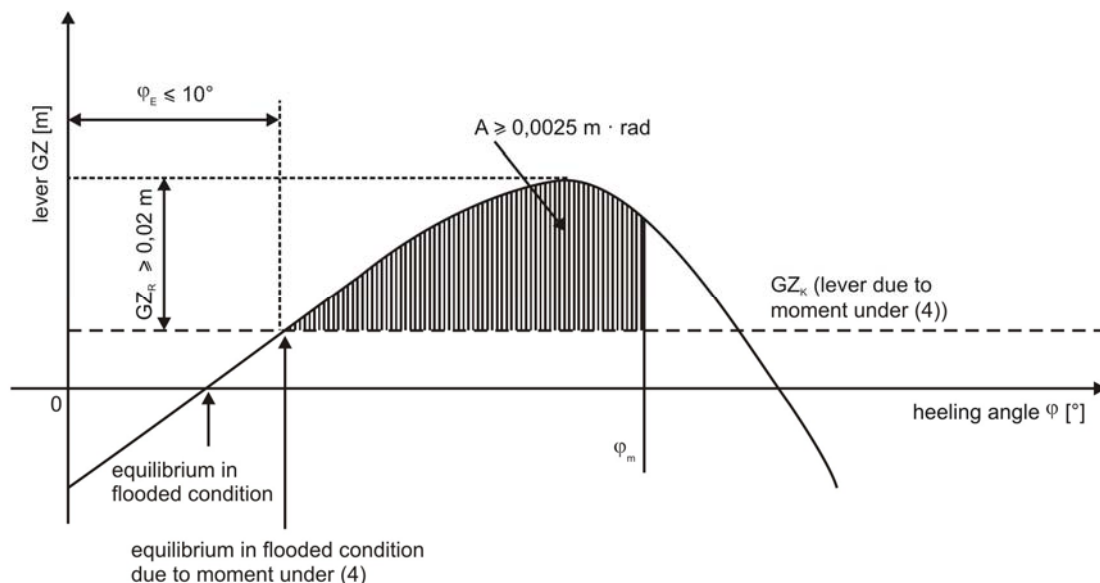

Where:

- φ_E is the heeling angle in the final stage of flooding taking into account the moment in accordance with section 4;
- φ_m is the angle of vanishing stability or the angle at which the first unprotected opening immerses or 25° ; whichever is less is to be used;
- GZ_R is the remaining righting lever in the final stage of flooding taking into account the moment in accordance with section 4;
- GZ_K is the heeling lever resulting from the moment in accordance with section 4.

- c) Non-watertight openings shall not be immersed before the equilibrium position has been reached. If such openings are immersed before this point, the rooms affording access are deemed to be flooded for damage stability calculation purposes.
12. The shut-off devices which shall be able to be closed watertight shall be marked accordingly.
13. If cross-flood openings to reduce asymmetrical flooding are provided, they shall meet the following conditions:
- a) for the calculation of cross-flooding, IMO Resolution MSC.362(92)¹ shall be applied;
 - b) they shall be self-activating;
 - c) they shall not be equipped with shut-off devices;
 - d) the total time allowed for compensation shall not exceed 15 minutes.

Article 19.04 ***Safety clearance and freeboard***

1. The safety clearance shall be at least equal to the sum of:
- a) the additional lateral immersion, which, measured on the outside plating, is resulting from the heeling angle due to persons, wind and turning according to Article 19.03(4), (5) and (6); and
 - b) the residual safety clearance of at least 0,10 m.

For vessels without a bulkhead deck, the safety clearance shall be at least 0,50 m.

2. The freeboard shall be at least equal to the sum of:
- a) the additional lateral immersion, which, measured on the outside plating, is resulting from the heeling angle due to persons, wind and turning according to Article 19.03(4), (5) and (6); and
 - b) the residual freeboard of at least 0,20 m.

However, the freeboard shall be at least 0,30 m.

3. The plane of maximum draught is to be set so as to ensure compliance with the safety clearance according to (1), and the freeboard according to (2) and Articles 19.02 and 19.03.

Article 19.05 ***Maximum permitted number of passengers***

1. The inspection body shall set the maximum permitted number of passengers and shall enter this number on the inland navigation vessel certificate.
2. The maximum permitted number of passengers shall not exceed any of the following values:
- a) number of passengers for whom the existence of a muster area according to Article 19.06(8), has been proven;

¹ MSC.362(92) adopted on 14 June 2013 - Revised Recommendation on a Standard Method for Evaluating Cross-Flooding Arrangements

- b) number of passengers that has been taken into account for the stability calculation according to Article 19.03;
 - c) number of available sleeping berths for passengers on cabin vessels used for voyages including overnight stays.
3. For cabin vessels which are also used as day trip vessels, the number of passengers shall be calculated for use both as a day trip vessel and as a cabin vessel and entered on the inland navigation vessel certificate.
 4. The maximum permitted number of passengers shall be displayed on clearly legible and prominently positioned notices on board the vessel and on the safety plan mentioned in Article 19.13(2).

Article 19.06 ***Passenger rooms and areas***

1. Passenger rooms shall:
 - a) on all decks, be located aft of the level of the collision bulkhead and, if they are below the bulkhead deck, forward of the level of the aft-peak bulkhead; and
 - b) be separated from the engine and boiler rooms in a gas-tight manner.

Deck areas which are enclosed by awnings or similar mobile installations not only above but also fully or partially to the side must satisfy the same requirements as enclosed passenger rooms.
2. Cupboards and rooms referred to in Article 14.13 and intended for the storage of flammable liquids shall be outside the passenger area.
3. The number and width of the exits of passenger rooms shall comply with the following requirements:
 - a) Rooms or groups of rooms designed or arranged for 30 or more passengers or including sleeping berths for 12 or more passengers shall have at least two exits which are as far apart from one another as possible. On day trip vessels one of these two exits can be replaced by two emergency exits. Rooms, with the exception of cabins, and groups of rooms that have only one exit, shall have at least one emergency exit.
 - b) If rooms are located below the bulkhead deck, one of the exits can be a watertight bulkhead door, according to Article 19.02(10), leading into an adjacent compartment from which the upper deck can be reached directly. The other exit shall lead directly or, if permitted in accordance with (a), as an emergency exit into the open air, or to the bulkhead deck. This requirement does not apply to individual cabins.
 - c) Exits according to (a) and (b) shall be suitably arranged and shall have a clear width of at least 0,80 m and also a clear height of at least 2,00 m. For doors of cabins and other small rooms, the clear width can be reduced to 0,70 m.
 - d) In the case of rooms or groups of rooms intended for more than 80 passengers the sum of the widths of all exits intended for passengers and which shall be used by them in an emergency shall be at least 0,01 m per passenger.
 - e) If the total width of the exits is determined by the number of passengers, the width of each exit shall be at least 0,005 m per passenger.

- f) Emergency exits shall have a shortest side at least 0,60 m long or a minimum diameter of 0,70 m. They shall open in the direction of escape and be marked on both sides.
 - g) Exits of rooms intended for use by persons with reduced mobility shall have a clear width of at least 0,90 m.
4. Doors of passenger rooms shall comply with the following requirements:
- a) With the exception of doors leading to connecting corridors, they shall be capable of opening outwards or be constructed as sliding doors.
 - b) Cabin doors shall be made in such a way that they can also be unlocked from the outside at any time.
 - c) Powered doors shall open easily in the event of failure of the power supply to this mechanism.
 - d) For doors intended for use by persons with reduced mobility, there shall be from the direction from which the door opens, a minimum clearance of 0,60 m between the inner edge of the doorframe on the lock side and an adjacent perpendicular wall. As an alternative, doors with an automatic release by a push button are also acceptable. The power for this remote control should be available at all times.
5. Connecting corridors shall comply with the following requirements:
- a) They shall have a clear width of at least 0,80 m. If they lead to rooms intended for more than 80 passengers, they shall comply with the provisions mentioned in (3)(d) and (e) regarding the width of the exits leading to connecting corridors.
 - b) Their clear height shall be not less than 2,00 m.
 - c) Connecting corridors intended for use by persons with reduced mobility shall have a clear width of 1,30 m. Connecting corridors more than 1,50 m wide shall have handrails on either side.
 - d) Where a part of the vessel or a room intended for passengers is served by a single connecting corridor, the clear width thereof shall be at least 1,00 m.
 - e) Connecting corridors shall be free of steps.
 - f) They shall lead only to open decks, rooms or staircases.
 - g) Dead ends in connecting corridors shall be not longer than two meters.
6. Escape routes must be available. In addition to the provisions of (5), escape routes shall also comply with the following requirements:
- a) Stairways, exits and emergency exits shall be so disposed that, in the event of a fire in any given area, the other areas may be evacuated safely.
 - b) The escape routes shall lead by the shortest route to muster areas according to (8).
 - c) Escape routes shall not lead through engine rooms or galleys.
 - d) There shall be no rungs, ladders or the like installed at any point along the escape routes.
 - e) Doors to escape routes shall be constructed in such a way as not to reduce the minimum width of the escape route referred to in (5)(a) or (d).
 - f) Escape routes and emergency exits shall be clearly signed. The signs shall be lit by the emergency lighting system.
7. Escape routes and emergency exits shall have a suitable safety guidance system.

8. For all persons on board, there shall be muster and evacuation areas available which satisfy the following requirements:
- a) The total area of the muster areas A_S shall correspond to at least the following value:
Day trip vessels: $A_S = 0,35 \cdot F_{max} [m^2]$
Cabin vessels: $A_S = 0,45 \cdot F_{max} [m^2]$
where
 F_{max} = maximum permitted number of passengers on board.
 - b) Each individual muster area shall be
 - aa) larger than 10 m² and
 - bb) appropriate for the number of passengers who will be guided to this muster area according to the evacuation procedure required in Article 19.13.
 - c) The muster and evacuation areas shall be clear of furniture, whether movable or fixed.
 - d) If movable furniture is located in a room in which muster or evacuation areas are defined, it shall be secured appropriately to avoid slipping.
 - e) If fixed seats or benches are located in a room in which muster areas are defined the corresponding number of persons need not be taken into account when calculating the total area of muster areas according to (a). However, the number of persons for whom fixed seats or benches in a certain room are taken into account must not exceed the number of persons for whom muster areas are available in this room.
 - f) Life-saving appliances shall be easily accessible from the muster or evacuation areas. In principle, the life-saving appliances shall be stored nearby or within the muster or evacuation areas.
 - g) An evacuation area shall be provided on each side of the vessel. It shall be possible to evacuate people safely from these evacuation areas to shallow water, to the bank or to another craft, using either side of the vessel.
 - h) The muster and evacuation areas shall lie above the margin line.
 - i) The muster and evacuation areas are to be shown as such in the safety plan. The muster area shall be signposted on board the vessel.
 - j) The provisions of (d) and (e) shall also apply to free decks on which muster or evacuation areas are defined.
 - k) If collective life-saving appliances complying with Article 19.09(5), are available on board, the number of persons for whom such appliances are available may be disregarded when calculating the total surface area of the muster areas referred to in (a).
 - l) However, in all cases where reductions according to (e), (j) and (k) are applied, the total area according to (a) shall be sufficient for at least 50 % of the maximum permitted number of passengers.
 - m) The evacuation areas must be accessible from each muster area without passengers having to pass through areas or rooms having lower levels of safety regarding fire protection.

9. Stairs and their landings in the passenger areas shall comply with the following requirements:
- a) They shall be constructed in accordance with European Standard EN 13056 : 2000.
 - b) They shall have a clear width of at least 0,80 m or, if they lead to connecting corridors or areas used by more than 80 passengers, the sum of the widths of all stairs intended for passengers and which shall be used by them in an emergency shall be at least 0,01 m per passenger.
 - c) The clear width between handrails shall be of at least 1,00 m if the stairs provide the only means of access to a room intended for passengers.
The clear width between handrails shall not exceed 1,80 m. If necessary, additional intermediate handrails shall be installed. If additional intermediate handrails are installed, the requirements applicable to stairs shall be met on each side of the handrails.
 - d) Where there is not at least one staircase on each side of the vessel in the same room, they shall lie in the safe area.
 - e) In addition, stairs intended for use by persons with reduced mobility shall comply with the following requirements:
 - aa) the gradient of the stairs shall not exceed 33°;
 - bb) the stairs shall have a clear width of at least 0,90 m;
 - cc) the stairs shall be straight and parallel to the longitudinal axis of the vessel;
 - dd) the handrails of the stairs shall extend approximately 0,30 m beyond the top and bottom of the stairs without restricting passageways;
 - ee) handrails, front sides of at least the first and the last step as well as the floor coverings at the ends of the stairs shall be colour highlighted.Lifts intended for persons with reduced mobility, and lifting equipment, like stairlifts or lifting platforms, shall be constructed according to a relevant standard or a regulation of a Member State.
10. Parts of the deck intended for passengers, and which are not enclosed, shall be surrounded by a fixed bulwark or guard rail at least 1,00 m high or a railing according to the European Standard EN 711 : 2016, construction type PF, PG or PZ. Bulwarks and railings of decks intended for use by persons with reduced mobility shall be at least 1,10 m high.
11. The parts of the vessel not intended for passengers, in particular access to the wheelhouse, to the winches and to the engine rooms, shall be such that they can be secured against unauthorised entry. At any such access, a symbol corresponding to Figure 1 in Annex 4 shall be displayed in a prominent position.
12. Openings and equipment for embarking and disembarking shall comply with the following requirements:
- a) They shall be equipped with devices to prevent falls overboard.
 - b) Openings shall have a clear width of at least 1,00 m.
 - c) Openings, used normally for the embarking or disembarking of persons with reduced mobility, shall have a clear width of at least 1,50 m. For the use of equipment to enable persons to be transferred such as gangways, fixed or mobile facilities must be available which close the distance between the inner edge of the exit opening and the outer edge of the equipment to enable persons to be transferred over its entire height in a child-proof manner.

- d) If the openings and equipment for embarking or disembarking cannot be observed from the wheelhouse, appropriate optical or electronic means shall be provided.
 - e) Gangways shall be constructed in accordance with European Standard EN 14206 : 2003. By way of derogation from Article 13.02(3)(d), their length can be less than 4 m.
13. Passageways intended for use by persons with reduced mobility shall have a clear width of 1,30 m and be free of doorsteps and sills more than 0,025 m high. Walls in passageways intended for use by persons with reduced mobility shall be equipped with handrails at a height of 0,90 m above the floor.
14. Glass doors and walls in passageways and also window panes shall be manufactured from pre-stressed glass or laminated glass. They may also be made from a synthetic material, provided this is authorised for use in a fire-protection context.
- Transparent doors and transparent walls extending as far as the floor in passageways shall be prominently marked.
15. Superstructures (or their roofs) consisting entirely of panoramic panes, shelters created by awnings, or similar mobile installations, together with their substructures, may only be constructed in such a manner that the way in which they are built and the materials employed pose no risk of injury to persons on board in the event of damage.
16. Potable water systems shall, at least, comply with the requirements of Article 15.05.
17. There shall be toilets available for passengers. At least one toilet shall be fitted for use by persons with reduced mobility according to a relevant standard or a regulation of a Member State and shall be accessible from areas intended for use by persons with reduced mobility.
- This shall have been fulfilled if the toilet meets the following requirements:
- a) The surface of the toilet is at least 1,50 m x 1,82 m;
 - b) At least 0,80 m of clearance shall be provided on at least one side of the toilet to facilitate accessibility for wheelchair users;
 - c) The height of the toilet seat is approximately 0,40 m;
 - d) Handgrips for persons with reduced mobility are fixed to the walls and attention given to ensuring that the fittings are quite stable and firmly attached;
 - e) The toilet-paper dispenser is within easy reach and can be used with one hand.
18. Cabins without an opening window shall be connected to a ventilation system.
19. *Mutatis mutandis*, rooms in which crew members or shipboard personnel are accommodated shall comply with the provisions of this Article.

Article 19.07 ***Propulsion system***

1. In addition to the main propulsion system, vessels shall be equipped with a second independent propulsion system so as to ensure that, in the event of a breakdown affecting the main propulsion system, the vessel can continue to make steerageway under its own power.

2. The second independent propulsion system must be located in a separate engine room or electrical service room. If both rooms have common partitions, these shall be built according to Article 19.11(2).

Article 19.08 ***Safety devices and equipment***

1. Passenger vessels shall have an internal communication facility according to Article 7.08. It shall also be available in the service rooms and, where there is no direct communication from the steering position, in the areas for embarking and disembarking passengers as well as muster areas and evacuation areas as referred to in Article 19.06(8).
2. All passenger areas shall be reachable via a loudspeaker system. The system shall be designed in such a way as to ensure that the information transmitted can be clearly distinguished from background noise. Loudspeakers are optional where direct communication between the steering position and the passenger area is possible.
3. The vessel shall be equipped with an alarm system. The system shall include:
 - a) an alarm system enabling passengers, crew members and shipboard personnel to alert the vessel's command and crew.

This alarm should be given only in areas assigned to the vessel's command and to the crew; it should only be possible for the vessel's command to stop the alarm. The alarm shall be capable of being triggered from at least the following places:

 - aa) in each cabin;
 - bb) in the corridors, lifts and stairwells, with the distance to the nearest trigger not exceeding 10 m and with at least one trigger per watertight compartment;
 - cc) in lounges, dining rooms and similar recreation rooms;
 - dd) in toilets, intended for use by persons with reduced mobility;
 - ee) in engine rooms, galleys and similar rooms where there is a fire risk;
 - ff) in the cold-storage rooms and other store rooms.

The alarm triggers shall be installed at a height above the floor of 0,85 m to 1,10 m;
 - b) an alarm system enabling the vessel's command to alert passengers.

This alarm shall be clearly and unmistakably audible in all rooms accessible to passengers. It shall be capable of being triggered from the wheelhouse and from a location that is permanently occupied by the crew or shipboard personnel;
 - c) an alarm system enabling the vessel's command to alert the crew and shipboard personnel, referred to in Article 7.09(1).

The alarm system shall also reach the recreation rooms for the shipboard personnel, the cold-storage rooms and other store rooms.

Alarm triggers shall be protected against unintentional use.

4. Each watertight compartment shall be fitted with a bilge level alarm.
5. Two motor-driven bilge pumps shall be provided.

6. A bilge pumping system with permanently installed pipe work shall be available.
7. Cold-storage room doors, even when locked, shall also be capable of being opened from the inside.
8. Where CO₂ bar-systems are situated in rooms below deck these rooms shall be fitted with an automatic ventilation system which turns itself on automatically when the door or hatch to the room is opened. The ventilation ducts shall run down to 0,05 m from the floor of this room. Ventilation systems for rooms where CO₂ bar systems are situated shall be independent from other ventilation systems.
9. In addition to the first-aid kit according to Article 13.02(3)(f), further first-aid kits shall be provided in sufficient number. The first-aid kits and their storage shall comply with the requirements set out in Article 13.02(3)(f).
10. Passenger vessels must be equipped with at least one automated external defibrillator. Its location is indicated by a symbol for 'automated external defibrillator' in accordance with Figure 12 of Annex 4, having a side length of at least 10 cm. The automated external defibrillator must be maintained in accordance with the manufacturer's instructions.

Article 19.09 ***Life-saving equipment***

1. In addition to the lifebuoys specified in Article 13.08(1), all parts of the deck intended for passengers and not enclosed shall be equipped with suitable lifebuoys, which shall be positioned on both sides of the vessel not more than 20 m apart. Lifebuoys shall be considered as suitable if they comply with
 - the European Standard EN 14144 : 2003; or
 - the International Convention for the Safety of Life at Sea (SOLAS 1974) Chapter III Regulation 7.1 and the International Life-Saving Appliance (LSA) Code, (2.1).

Half of all the prescribed lifebuoys shall be fitted with a buoyant cord at least 30 m long with a diameter of 8 to 11 mm. The other half of the prescribed lifebuoys shall be fitted with a self-igniting, battery-powered light which will not be extinguished in water.
2. In addition to the lifebuoys referred to in (1), individual life-saving equipment according to Article 13.08(2) shall be within reach for all shipboard personnel. For shipboard personnel not responsible for undertaking duties according to the safety rota non-inflatable or semi-automatically inflatable lifejackets in accordance with (a) or (b) of Article 13.08(2) are allowed.
3. Passenger vessels shall have appropriate equipment to enable persons to be transferred safely to shallow water, to the bank or to another craft.
4. In addition to the life-saving equipment referred to in (1) and (2), individual life-saving equipment according to Article 13.08(2), shall be available for 100 % of the maximum permitted number of passengers. Non-inflatable or semi-automatically inflatable lifejackets in accordance with (a) or (b) of Article 13.08(2) are allowed.

5. The term 'collective life-saving appliances' covers ship's boats according to Article 13.07 and life rafts.
- Life rafts shall:
- a) bear a notice indicating their purpose and the number of persons for whom they are approved;
 - b) offer adequate seating space for the permitted number of persons;
 - c) provide a buoyancy of at least 750 N per person in fresh water;
 - d) be provided with a rope linked to the passenger vessel to prevent them drifting away;
 - e) be made of suitable materials and be resistant to oil, oil products and temperatures up to 50 °C;
 - f) assume and maintain a stable trim and, in this respect, be fitted with appropriate devices enabling them to be grabbed by the indicated number of persons;
 - g) be fluorescent orange in colour or have fluorescent surfaces, visible from all sides, of at least 100 cm²;
 - h) be such that they can be released from their stowed position and put overboard quickly and safely by one person, or can float free from their stowed position;
 - i) be provided with appropriate means of evacuation from the evacuation areas referred to in Article 19.06(8), onto the life rafts if the vertical distance between the deck of the evacuation areas and the plane of maximum draught is greater than 1 m.
6. Additional collective life-saving appliances are items of life-saving equipment which ensure the buoyancy of several persons in the water. These shall:
- a) bear a notice indicating their purpose and the number of persons for whom they are approved;
 - b) provide a buoyancy of at least 100 N per person in fresh water;
 - c) be made of suitable materials and be resistant to oil, oil products and to temperatures of up to 50 °C;
 - d) assume and maintain a stable trim and, in this respect, be fitted with appropriate devices enabling them to be grabbed by the indicated number of persons;
 - e) be fluorescent orange in colour or have fluorescent surfaces, visible from all sides, of at least 100 cm²;
 - f) be such that they can be released from their stowed position and put overboard quickly and safely by one person, or can float free from their stowed position.
7. Inflatable collective life-saving appliances shall in addition:
- a) comprise at least two separate air compartments;
 - b) inflate automatically or by manual command when launched;
 - c) assume and maintain a stable trim irrespective of the load to be supported, even when only half the air compartments are inflated.
8. The life-saving appliances shall be stowed on board in such a way that they can be reached easily and safely when required. Concealed storage places shall be clearly marked.
9. Life-saving equipment shall be inspected according to the manufacturer's instructions.
10. The ship's boat shall be equipped with an engine and a searchlight.
11. A suitable stretcher shall be available.

Article 19.10 ***Electrical Equipment***

1. Only electrical equipment shall be permitted for lighting.
2. Article 10.16(3), shall also apply additionally for passenger rooms.
3. For the following rooms and locations, adequate lighting and emergency lighting shall be provided:
 - a) locations where life-saving equipment is stored and where such equipment is normally prepared for use;
 - b) escape routes, access for passengers, including gangways, entrances and exits, connecting corridors, lifts and accommodation area companionways, cabin areas and accommodation areas;
 - c) markings on the escape routes and emergency exits;
 - d) in other areas intended for use by persons with reduced mobility;
 - e) service rooms, engine rooms, steering equipment rooms and their exits;
 - f) wheelhouse;
 - g) emergency electrical power source room;
 - h) points at which extinguishers and fire extinguishing equipment controls are located;
 - i) muster areas and evacuation areas referred to in Article 19.06(8);
 - j) locations where an automated external defibrillator is to be found.
4. There shall be an emergency power plant, consisting of an emergency electrical power source and emergency switchboard, which, in the event of a failure of the supply to the following electrical equipment, can immediately take over as their replacement supply, where the equipment does not have its own electrical power source:
 - a) navigation lights;
 - b) audible warning devices;
 - c) emergency lighting in accordance with (3);
 - d) radiotelephone installations;
 - e) alarm, loudspeaker and on-board message communications systems;
 - f) searchlights according to Article 13.02(2)(i);
 - g) fire alarm system;
 - h) other safety equipment such as automatic pressurised water sprinkler systems or fire extinguishing pumps;
 - i) lifts and lifting equipment within the meaning of Article 19.06(9), second sentence.
5. The light fittings for the emergency lighting shall be marked as such.
6. The emergency power plant shall be installed outside the main engine room, outside the rooms housing the power sources referred to in Article 10.02(1), and outside the room where the main switchboard is located; it shall be separated from these rooms by partitions according to Article 19.11(2).

Cables feeding the electrical installations in the event of an emergency shall be installed and routed in such a way as to maintain the continuity of supply of these installations in the event of fire or flooding. These cables shall never be routed through the main engine room, galleys or rooms where the main power source and its connected equipment is installed, except insofar as it is necessary to provide emergency equipment in such areas.

The emergency power plant shall be installed either above the margin line or as far away as possible from the power sources according to Article 10.02(1), so as to ensure that, in the event of flooding in accordance with Article 19.03(9), it is not flooded at the same time as these power sources.

7. The following are admissible for use as an emergency electrical power source:
 - a) auxiliary generator sets with their own independent fuel supply and independent cooling system which, in the event of a power failure, turn on and take over the supply of power within 30 seconds automatically or, if they are located in the immediate vicinity of the wheelhouse or any other location permanently manned by crew members, can be turned on manually; or
 - b) accumulator batteries, which, in the event of a power failure, turn on automatically or, if they are located in the immediate vicinity of the wheelhouse or any other location permanently manned by crew members, can be turned on manually. They shall be capable of powering the abovementioned power consumers throughout the prescribed period without recharging and without an unacceptable voltage reduction.
8. The projected operating period for the emergency power supply is to be defined according to the purpose of the passenger vessel. It shall not be less than 30 minutes.
9. The insulation resistances and the earthing for electrical systems shall be tested on the occasion of periodical inspections.
10. The power sources according to Article 10.02(1), shall be independent of each other.
11. A failure of the main or emergency power equipment shall not mutually affect the operational safety of the installations.

Article 19.11 ***Fire protection***

1. The suitability for fire protection of materials and components shall be established by an accredited test institution on the basis of appropriate test methods.
 - a) The test institution shall satisfy:
 - aa) the Code for Fire Test Procedures; or
 - bb) European Standard EN 17025 : 2017.
 - b) The recognised test methods for determining the non-flammability of materials are:
 - aa) Annex 1, Part 1, of the Code for Fire Test Procedures; and
 - bb) the equivalent regulations of one of the Member States.

- c) The recognised test methods for determining that a material is flame-retardant are:
 - aa) the respective requirements laid down in Annex 1, Parts 5 (Test for surface flammability - Test for surface materials and primary deck coverings), 7 (Test for vertically supported textiles and films), 8 (Test for upholstered furniture) and 9 (Test for bedding components) of the Code for Fire Test Procedures; and
 - bb) the equivalent regulations of one of the Member States.
- d) The recognised test methods for determining fire resistance are:
 - aa) Annex 1, Parts 3 and 11, of the Code for Fire Test Procedures, and
 - bb) the equivalent regulations of one of the Member States.
- e) The recognised test methods for determining that a material is fire-restricting are:
 - aa) Annex 1, Part 10, of the Code for Fire Test Procedures; and
 - bb) the equivalent regulations of one of the Member States.
- f) The inspection body may, in accordance with the Code for Fire Test Procedures, prescribe a test on a sample partition in order to ensure compliance with the provisions of (2) on resistivity and temperature increase.

2. Partitions

For determining the appropriate fire partition to be applied to boundaries between adjacent rooms or areas, such rooms or areas are classified according to their fire risk as shown in categories below. A non-exhaustive list of rooms or areas is given for each category. In case a new type of room or area is foreseen, it may be placed in the relevant fire risk category as found appropriate by the Inspection body. Where contents and use of a room or area leave a doubt regarding its classification for the purpose of this regulation, or where it is possible to assign two or more classifications to a room or area, it shall be treated as a room or area within the relevant category having the most stringent partition requirements.

- a) Partitions between rooms / areas shall be designed in accordance with the following tables:
 aa) Table for partitions between rooms or areas, in which no pressurised water sprinkler systems according to Article 13.04 are installed

Rooms / areas	Rooms / areas protected for functional need	Rooms of major fire risk	Rooms of high fire risk	Rooms of moderate fire risk	Rooms of low fire risk
Rooms / areas included in the category	Control centres Switchboard rooms Stairwells Muster areas Evacuation areas Rooms containing sprinkler pumps, their switches and the valves that are required in order for the system to be operated	Engine rooms Accumulator rooms	Galleys Stores rooms containing flammable liquids	Store rooms Rooms containing Sauna Laundries Electrical service rooms	Lounges Barber shops and beauty parlours Cabins Corridors Other machinery / technical spaces (e.g. sewage treatment, ventilation, steering gear room)
Rooms / areas protected for functional need	A0 / B0 ^{1), 7), 9)}	A60	A60	A30	A30 / B15 ^{2), 9)}
Rooms of major fire risk		A60 / A0 ⁴⁾	A60	A60	A60
Rooms of high fire risk			A30 ⁷⁾	A30 / B15 ⁶⁾	A30
Rooms of moderate fire risk				A30 ^{3) 7)}	A30 ³⁾
Rooms of low fire risk					B15 ⁸⁾

bb) Table for partitions between rooms or areas, in which pressurised water sprinkler systems according to Article 13.04 are installed (a pressured water sprinkler system is installed in the rooms on both sides of the partition).

Rooms / areas	Rooms / areas protected for functional need	Rooms of major fire risk	Rooms of high fire risk	Rooms of moderate fire risk	Rooms of low fire risk
Rooms / areas included in the category	Control centres Switchboard rooms Stairwells Muster areas Evacuation areas Rooms containing sprinkler pumps, their switches and the valves that are required in order for the system to be operated	Engine room Accumulator room	Galley Store rooms containing flammable liquids	Store rooms Rooms containing Sauna Laundry Electrical service rooms	Lounges Barber shops and beauty parlours Cabins Corridors Other machinery / technical spaces (e.g. sewage treatment, ventilation, steering gear room)
Rooms / areas protected for functional need	A0 / B0 ^{1), 7), 9)}	A60	A30	A0 / A30 ^{5), 9)}	A0 / A30 / B15 ^{2), 9)}
Rooms of major fire risk		A60 / A0 ⁴⁾	A60	A60	A60
Rooms of high fire risk			A30 ⁷⁾	A30 / B15 ⁶⁾	A30
Rooms of moderate fire risk				A0 ⁷⁾	A0
Rooms of low fire risk					B0 ⁸⁾

- 1) Partitions between control centres and external muster areas shall correspond only to Type B0.
- 2) For rooms which are not protected by a sprinkler system; partitions between rooms of low fire risk and external muster areas shall correspond to Type B15. In all other cases they shall comply with Type A30.
For rooms which are protected by a pressured water sprinkler system; partitions between rooms of low fire risk and internal muster areas shall correspond to Type A30, but external muster areas only to Type B15. In all other cases they shall comply with Type A0.
- 3) Partitions between rooms of accommodation or passenger rooms shall correspond only to Type A0.
- 4) Partitions between engine rooms shall comply with Type A0, except for rooms according to Articles 19.07 and 19.10(6), which shall comply with A60. In all other cases they shall comply with Type A60.
- 5) Partitions between rooms of moderate fire risk and muster areas shall correspond to Type A30.
- 6) No partition is required between galleys and adjacent food store rooms provided that outer perimeter of galleys including stores fulfills the requirements for galleys.
- 7) Where adjacent rooms have the same purpose, the partitions need not to comply with the requirements of this table (for example; the partition between two stores).
- 8) Where adjacent technical spaces have the same purpose, the partitions made of material other than steel need not to comply with the requirements of this table, however, a smoke-tight division of non-combustible or fire restricting material is required.
- 9) Partitions between rooms containing pumps, switching mechanisms and valves of fire-fighting systems referred to in Article 13.05(14)(c) and adjacent rooms shall correspond at least to Type A30.

- cc) For partitions made of material other than steel, type A and type B partitions can be replaced by partitions providing following characteristics:

Type A / Type B partition	Transmission of smoke and flames in minutes	Insulation value in minutes (according Article 19.11(2)(d)(cc))
B0	30	0
B15	30	15
A0	60	0
A30	60	30
A60	60	60

The suitability of the fire protection of those partitions shall be established according to Article 19.11(1)(d), with the fire on the side of the rooms and areas of major fire risk, high fire risk and moderate fire risk.

- b) Type A partitions are bulkheads, walls and decks which meet the following requirements:
- aa) They are made of steel or of another equivalent material;
 - bb) They are appropriately stiffened;
 - cc) They are insulated with an approved non-combustible material such that the average temperature on the side facing away from the fire rises to not more than 140 °C above the initial temperature and at no point, including the gaps at the joints, does a temperature increase of more than 180 °C above the initial temperature occur within the following specified periods:
 - Type A60 60 minutes
 - Type A30 30 minutes
 - Type A0 0 minutes;
 - dd) they are constructed in such a way as to prevent the transmission of smoke and flames until the end of the one-hour standard fire test;
- c) Type B partitions are bulkheads, walls, decks, ceilings or facings which meet the following requirements:
- aa) they are made of an approved non-combustible material. Furthermore, all materials used in the manufacture and assembly of partitions shall be non-combustible, except for the facing, which shall be at least flame retardant;
 - bb) they demonstrate an insulation value such that the average temperature on the side facing away from the fire rises to not more than 140 °C above the initial temperature and at no point, including the gaps at the joints, does a temperature increase of more than 225 °C above the initial temperature occur within the following specified periods:
 - Type B15 15 minutes
 - Type B0 0 minutes;
 - cc) they are constructed in such a way as to prevent the transmission of flames until the end of the first half hour of the standard fire test.

- d) Partitions made of fire-restricting materials are bulkheads, walls, decks, ceilings or facings which meet the following requirements:
 - aa) they are constructed in fire-restricting material and are suitably stiffened;
 - bb) they are constructed in such a way as to prevent the transmission of flames and smokes according to Article 19.11(2)(b)(dd) and (c)(cc) as applicable;
 - cc) they demonstrate an insulation according to Article 19.11(2)(b)(cc) and (c)(bb) as applicable;
 - dd) partitions which are part of the load carrying construction shall also comply with Article 19.02(1a);
 - ee) the insulation is to be placed on each side of the partitions in accordance with the fire risk of that room;
 - ff) the upper side of deck within rooms protected by a water-based fixed firefighting installation need not to be insulated.
3. Paints, lacquers and other surface treatment products as well as deck coverings used in rooms except engine rooms and store rooms shall be flame-retardant. Carpets, fabrics, curtains and other hanging textile materials as well as upholstered furniture and components of bedding shall be flame-retardant if the rooms in which they are located are not equipped with a pressurised water sprinkler system according to Article 13.04.
4. Lounge ceilings and wall claddings, including their substructures, shall, where these lounges do not have a pressurised water sprinkler system in accordance with Article 13.04, be manufactured from non-combustible materials with the exception of their surfaces, which shall be at least flame-retardant. The first sentence shall not apply to saunas.
5. Furniture and fittings in lounges which serve as muster areas shall, where the rooms do not have a pressurised water sprinkler system according to Article 13.04, be manufactured from non-combustible materials.
6. None of the exposed surfaces, including paints, lacquers and other materials shall produce excessive amounts of smoke or toxic substances. This shall be proven in accordance with the Code for Fire Test Procedures (Annex 1, Part 2) or the appropriate regulations of one of the Member States.
7. Insulation materials in lounges shall be non-combustible. This does not apply to insulations used on coolant-carrying pipes. The surfaces of the insulation materials used on these pipes shall be at least flame-retardant.
8. Awnings and similar mobile installations with which deck areas are fully or partially enclosed and their substructures shall be at least flame-retardant.
9. Doors in partitions according to (2) shall satisfy the following requirements:
 - a) They shall satisfy the same requirements set out in (2) as the partitions themselves.
 - b) They shall be self-closing in the case of doors in partition walls according to (11) or in the case of enclosures around engine rooms, galleys and stairwells.

- c) Self-closing doors which remain open in normal operation shall be such that they can be closed on the spot and from a location permanently occupied by shipboard personnel or crew members. Once a door has been remotely closed, it shall be possible to reopen and close it safely on the spot.
 - d) Watertight doors according to Article 19.02 need not be insulated.
10. Walls according to (2) shall be continuous from deck to deck or end at continuous ceilings, which satisfy the same requirements as referred to in (2).
11. The following passenger areas shall be divided by vertical partitions as referred to in(2):
- a) passenger areas with a total surface area of more than 800 m²;
 - b) passenger areas in which there are cabins, at intervals of not more than 40 m.

The vertical partitions shall be smoke-tight under normal operating conditions and shall be continuous from deck to deck.

12. Hollows above ceilings, beneath floors and behind wall claddings shall be separated at intervals of not more than 14 m by non-combustible draught stops which, even in the event of fire, provide an effective fireproof seal.
13. Stairs shall be made of steel or another equivalent material in terms of fire-resistance.
14. Internal stairs and lifts shall be encapsulated at all levels by walls according to (2). The following exceptions are permissible:
- a) a staircase connecting only two decks does not need to be encapsulated, if on one of the decks the staircase is enclosed according to (2).
 - b) in a lounge, stairs need not be encapsulated if they are located entirely within the interior of this room, and
 - aa) if this room extends over only two decks, or
 - bb) if there is a pressurised sprinkler system according to Article 13.04 installed in this room on all decks, this room has a smoke extraction system according to (17) and the room has access on all decks to a stairwell.
15. Ventilation systems and air supply systems shall satisfy the following requirements:
- a) they shall be designed in such a way as to ensure that they themselves do not cause the spread of fire and smoke.
 - b) openings for air intake and extraction and air supply systems shall be such that they can be closed off.
 - c) ventilation ducts shall be made from steel or an equivalent non-combustible material and be securely connected to each other and to the superstructure of the vessel.
 - d) when ventilation ducts with a cross-section of more than 0,02 m² are passed through partitions according to (2) of Type A or partitions according to (11), they shall be fitted with automatic fire dampers which can be operated from a location permanently manned by shipboard personnel or crew members.

- e) ventilation systems for galleys and engine rooms shall be separated from ventilation systems which supply other areas.
 - f) air extraction ducts shall be provided with lockable openings for inspection and cleaning. These openings shall be located close to the fire dampers.
 - g) built-in ventilators shall be such that they can be switched off from a central location outside the engine room.
16. Galleys shall be fitted with ventilation systems. Stoves and similar cooking appliances shall be fitted with extractors. The air extraction ducts of the extractors shall satisfy the requirements according to (15) and, additionally, be fitted with manually operated fire dampers at the inlet openings.
17. Control centres, stairwells and internal muster areas shall be fitted with natural or mechanical smoke extraction systems. Smoke extraction systems shall satisfy the following requirements:
- a) they shall offer sufficient capacity and reliability.
 - b) they shall comply with the operating conditions for passenger vessels.
 - c) if smoke extraction systems also serve as general ventilators for the rooms, this shall not hinder their function as smoke extraction systems in the event of a fire.
 - d) smoke extraction systems shall have a manually operated triggering device.
 - e) mechanical smoke extraction systems shall additionally be such that they can be operated from a location permanently occupied by shipboard personnel or crew members.
 - f) natural smoke extraction systems shall be fitted with an opening mechanism, operated either manually or by a power source inside the extraction system.
 - g) manually operated triggering devices and opening mechanisms shall be accessible from inside or outside the room being protected.
18. Lounges not constantly supervised by shipboard personnel or crew members, galleys, engine rooms and other rooms presenting a fire risk shall be connected to an appropriate fire alarm system. The fire alarm and the fire detection zone shall be automatically displayed by an indicator device at a location permanently manned by shipboard personnel or crew members.
19. All rooms made of combustible materials, such as Fibre-Reinforced Plastic composites, which are not engine rooms, empty cells or tanks forming part of the ship's hull, shall be equipped with a permanently installed firefighting system according to Article 13.04 or Article 13.05 depending on the type of rooms.

Article 19.12 ***Fire-fighting***

1. In addition to the portable extinguishers according to Article 13.03, at least the following portable extinguishers shall be available on board:
- a) one portable extinguisher for every 120 m² of gross floor area in passenger rooms;
 - b) one portable extinguisher per group of 10 cabins, rounded upwards;
 - c) one portable extinguisher in each galley and in the vicinity of any room in which flammable liquids are stored or used. In galleys the extinguishing agent shall also be suitable for fighting fat fires.

These additional fire extinguishers shall meet the requirements laid down in Article 13.03(2), and be installed and distributed on the vessel so that, in the event of a fire starting at any point and at any time, a fire extinguisher can be reached immediately. In every galley and also in hairdressing salons and perfumeries, there shall be a fire blanket to hand.

2. Passenger vessels shall be provided with a hydrant system consisting of:
 - a) two motor-driven fire extinguishing pumps of sufficient capacity, at least one of which is permanently installed;
 - b) one fire extinguisher line with a sufficient number of hydrants with permanently connected fire extinguisher hoses at least 20 m in length and fitted with a nozzle capable of producing both a mist and a jet of water and incorporating a shut-off facility.
3. Hydrant systems shall be designed and dimensioned in such a way that:
 - a) any point of the vessel can be reached from at least two hydrants in different places, each with a single hose length of not more than 20 m;
 - b) the pressure at the hydrants is at least 300 kPa; and
 - c) on all decks a water jet length of at least 6 m can be attained.

If a hydrant cupboard is provided, an 'extinguisher hose' symbol similar to that shown in Figure 5 in Annex 4, of at least 10 cm side length, shall be affixed to the outside of the cupboard.

4. Hydrant valves with screw threads or cocks shall be such that they can be set so that each of the fire extinguisher hoses can be separated and removed during operation of the fire extinguishing pumps.
5. Fire extinguisher hoses in the internal area shall be rolled up on an axially connected reel.
6. Materials for fire-fighting equipment shall either be heat-resistant or shall be suitably protected against failure to work when subjected to high temperatures.
7. Pipes and hydrants shall be arranged in such a way that the risk of freezing is avoided.
8. The fire extinguishing pumps shall:
 - a) be installed or housed in separate rooms;
 - b) be such that they can be operated independently of each other;
 - c) each be capable, on all decks, of maintaining the necessary pressure at the hydrants and achieving the requisite length of water jet;
 - d) be installed forward of the aft-peak bulkhead.

Fire extinguishing pumps may also be used for general purposes.

9. Engine rooms shall be fitted with a permanently fitted fire extinguishing system according to Article 13.05.
10. On cabin vessels there shall be:
 - a) two self-contained breathing apparatus sets corresponding to European Standard EN 137 : 2006 of Type 2 with full-face masks corresponding to European Standard EN 136 : 1998;

- b) two sets of equipment consisting of at least a protective suit, helmet, boots, gloves, axe, crowbar, torch and safety-line,
- c) four smoke hoods.

Article 19.13 **Safety organisation**

1. A safety rota shall be provided on board passenger vessels. The safety rota describes the duties of the crew and the shipboard personnel in the following eventualities:
 - a) breakdown;
 - b) fire on board;
 - c) evacuation of passengers;
 - d) person overboard.

Specific safety measures for persons with reduced mobility shall be taken into consideration.

The crew members and shipboard personnel designated in the safety rota should be assigned their various duties, depending on the posts they occupy. Special instructions shall ensure that, in the event of danger, all doors and openings in the watertight bulkheads referred to in Article 19.02 will be hermetically closed immediately.

2. A safety plan shall be provided on board passenger vessels, in which at least the following are clearly and precisely designated:
 - a) areas intended for use by persons with reduced mobility;
 - b) escape routes, emergency exits and muster and evacuation areas;
 - c) life-saving equipment (including ship's boat) referred to in Article 19.09;
 - d) fire extinguishers referred to in Article 19.12(1);
 - e) fire extinguishing and pressurised sprinkler systems referred to in Article 19.12;
 - f) hydrants and hoses referred to in Article 19.12(2) and (3);
 - g) fire fighting pumps referred to in Article 19.12(2) and bilge pumps referred to in Article 8.08;
 - h) alarm system referred to in Article 19.08(3)(a);
 - i) alarm system referred to in Article 19.08(3)(b) and (c);
 - j) bulkhead doors referred to in Article 19.02(5), and the position of their controls, as well as the other openings referred to in Article 19.02(9), (10) and (13), and Article 19.03(12);
 - k) type A partitions referred to in Article 19.11(2) and partitions referred to in Article 19.11(11), as well as doors in such partitions;
 - l) automatic fire dampers, including the location of their controls, referred to in Article 19.11(15)(d) and manually operated fire dampers referred to in Article 19.11(16);
 - m) fire alarm system referred to in Article 19.11(18);
 - n) emergency power plant referred to in Article 19.10(4);
 - o) ventilation system control units referred to in Article 19.11(15)(g);
 - p) electrical shore connections referred to in Article 10.08;

- q) fuel line shut-offs referred to in Article 8.05(7);
- r) liquefied gas installations referred to in Article 19.15(8);
- s) public address systems referred to in Article 19.08(2);
- t) radiotelephone equipment;
- u) first-aid kits referred to in Article 19.08(9);
- v) the automated external defibrillator referred to in Article 19.08(10);
- w) self-contained breathing apparatus sets, as well as sets of equipment and smoke hoods referred to in Article 19.12(10);
- x) fire blanket referred to in Article 19.12(1);
- y) closing devices of ventilation air intake and extraction referred to in Article 19.11(15)(b);
- z) smoke extraction system triggering devices referred to in Article 19.11(17)(g).

The symbols used in the safety plan shall be in accordance with the international standard ISO 17631 : 2022 or other recognized standards.

3. The safety rota according to (1) and the safety plan according to (2) shall:
 - a) be duly stamped by the inspection body,
 - b) be available at a location permanently manned by shipboard personnel or crew members, and
 - c) be permanently stored in a prominently marked weathertight enclosure outside the deckhouse for the assistance of shoreside fire-fighting personnel.
4. A simplified safety plan containing only the information referred to in (2)(a) to (d), (h), (u) and (v) shall be prominently displayed at an appropriate point on each deck and shall be posted up in each cabin. By derogation, the safety plan according to (2) can be used instead of the simplified safety plan.
5. A code of conduct for passengers shall be prominently displayed at an appropriate point on each deck and shall be posted up in each cabin.

This code of conduct shall include at least:

- a) designation of emergencies:
 - aa) fire;
 - bb) flooding;
 - cc) general hazard;
- b) description of the various alarm signals;
- c) instructions concerning the following:
 - aa) escape routes;
 - bb) what to do;
 - cc) need to keep calm;
- d) instructions concerning the following:
 - aa) smoking;
 - bb) use of fire and naked flame;
 - cc) opening windows;
 - dd) use of certain items of equipment.

These details shall be posted up in Dutch, English, French and German.

Article 19.14

Waste water collection and disposal facilities

1. Passenger vessels shall be equipped with collection tanks for domestic waste water in accordance with (2) of this Article or appropriate on-board sewage treatment plants in accordance with Chapter 18.
2. Waste water collection tanks shall have sufficient capacity. Tanks shall be fitted with a device to indicate their content level. There shall be on-board pumps and pipes for emptying the tanks, whereby waste water can be passed from both sides of the vessel. It shall be possible to pass waste water from other vessels onwards.

The pipes shall be fitted with a connection for the discharge of waste water according to European Standard EN 1306 : 2018.

3. For passenger vessels that do not produce domestic waste water, the inspection body may waive the application of (1). This derogation shall be entered in item 52 of the inland navigation vessel certificate.

Article 19.15

Derogations for certain passenger vessels

1. Passenger vessels authorised to carry up less than 50 passengers and with a length L_{WL} of not more than 25 m shall prove adequate stability after damage according to Article 19.03(7 to 13) or, as an alternative, prove that they comply with the following criteria after flooding of each single compartment:
 - a) the immersion of the vessel shall not exceed the margin line and
 - b) the residual metacentric height GM_R shall not be less than 0,10 m.

The necessary residual buoyancy shall be assured through the appropriate choice of material used for the construction of the hull or by means of highly cellular foam floats, solidly attached to the hull. In the case of vessels with a length of more than 15 m, residual buoyancy can be ensured by a combination of floats and subdivision complying with the 1-compartment status according to in Article 19.03.

- 1a. The inspection body may waive the application of Article 19.09(1) for passenger vessels in accordance with (1).
2. For passenger vessels in accordance with (1) the inspection body may permit minor derogations from the clear height required in Article 19.06(3)(c) and (5)(b). The derogation shall not be more than 5 %. In the case of derogations the relevant parts shall be indicated by colour.
3. By way of derogation from Article 19.03(9), passenger vessels with a length L of not more than 45 m and authorised to carry up to a maximum of 250 passengers do not need to have 2-compartment status.

In addition, by way of derogation from Article 19.03(9), passenger vessels with a length L_{WL} of not more than 25 m and authorised to carry up to a maximum of 150 passengers shall have 1-compartment status with the following dimensions of the side and bottom damage : $0,10 \cdot L_{WL}$, however not less than 2,00 m.

4. The inspection body may waive the application of Article 13.07 in the case of passenger vessels authorised to carry up to a maximum of 250 passengers and with a length L_{WL} of not more than 25 m, provided they are equipped with a platform, accessible from each side of the vessel, directly above the line of flotation, so as to enable persons to be recovered from the water. Passenger vessels may be equipped with a comparable installation, subject to the following conditions:
 - a) one person alone shall be able to operate the installation;
 - b) mobile installations are allowed;
 - c) the installations shall be outside the danger area of the propulsion systems; and
 - d) effective communication shall be possible between the boatmaster and the person in charge of the installation.
5. The inspection body may waive the application of Article 13.07 in the case of passenger vessels authorised to carry up to a maximum of 600 passengers and with a length L of not more than 45 m, provided they are equipped with a platform according to (4), first sentence, or with an equivalent installation according to (4), second sentence. In addition, the passenger vessel shall have:
 - a) a rudder propeller, a cycloidal propeller or a water jet as main propulsion, or
 - b) a main propulsion system with two propulsion units, or
 - c) a main propulsion system and a bow-thruster.
6. By way of derogation from Article 19.02(9), passenger vessels with a length L of not more than 45 m and authorised to carry at most a number of passengers corresponding to the length of the vessel in metres are allowed to have on board, in the passenger area, a manually controlled bulkhead door without remote control according to Article 19.02(5), if:
 - a) the vessel has only one deck;
 - b) this door is accessible directly from the deck and is not more than 10 m away from the deck;
 - c) the lower edge of the door opening lies at least 30 cm above the floor of the passenger area, and
 - d) each of the compartments divided by the door is fitted with a bilge level alarm.
7. On passenger vessels in accordance with (6), by way of derogation from Article 19.06(6)(c), one escape route may lead through a galley, as long as there is a second escape route available.
8. For passenger vessels with a length L of not more than 45 m the following shall not apply: Article 19.01(2)(e), when the liquefied gas installations are fitted with suitable gas warning equipment for CO concentrations posing a health risk and for potentially explosive mixtures of gas and air.
9. The following provisions shall not apply to passenger vessels with a length L_{WL} of not more than 25 m:
 - a) Article 19.04(1), last sentence;
 - b) Article 19.06(6)(c), for the galleys, as long as a second escape route is available;
 - c) Article 19.06(8)(b)(aa);
 - d) Article 19.07.

10. For cabin vessels with a length L of not more than 45 m, Article 19.12(10), shall not apply, provided smoke-hoods in a number corresponding to the number of sleeping berths are readily accessible in each cabin.
11. For passenger vessels with a length L_{WL} of not more than 25 m, the fire extinguisher hoses according to Article 19.12(2)(b) can be shorter than 20 m in length, subject that any point of the vessel can be reached.
12. For day-trip vessels operating limited journeys of local interest or in harbour areas, the inspection body may waive the application of Article 19.06(17). However, the absence of toilets shall be entered in item 52 of the inland navigation vessel certificate. The journeys or areas for which the derogation is valid shall be specified in the inland navigation vessel certificate.
13. For day-trip vessels operating limited journeys of local interest or in harbour areas, the inspection body may authorise a shorter time than the 30 minutes required in Article 7.04(11). The journeys or areas for which such derogation is valid shall be specified in the inland navigation vessel certificate.

CHAPTER 20
SPECIAL PROVISIONS APPLICABLE TO PASSENGER SAILING VESSELS NOT
NAVIGATING ON THE RHINE (ZONE R)

Article 20.01
Application of Parts II and III

In addition to the provisions of Parts II and III, the requirements in this Chapter shall apply to passenger sailing vessels not navigating on the Rhine (Zone R).

Article 20.02
Exceptions for certain passenger sailing vessels

1. For passenger sailing vessels having an L_{WL} not exceeding 45 m and a maximum permissible number of passengers not exceeding L_{WL} in whole meters, the following provisions shall not apply:
 - a) Article 3.03(7), provided that anchors are not stored in hawse pipes;
 - b) Article 13.02(2)(d), with regard to length;
 - c) Article 19.08(3)(a);
 - d) Article 19.15(8).
2. By way of derogation from (1), the number of passengers may be raised to 1,5 times the L_{WL} in whole meters, if sails, rigging and deck fittings so permit.

Article 20.03
Stability requirements for vessels under sail

1. For the calculation of the heeling moment according to Article 19.03(3), the furled sails shall be taken into account when determining the centre of gravity of the vessel.
2. Taking into consideration all loading conditions according to Article 19.03(2), and using a standard arrangement of sails, the heeling moment caused by wind pressure shall not be so high as to exceed a heeling angle of 20°. At the same time
 - a) a constant wind pressure of 0,07 kN/m² shall be applied for the calculation;
 - b) the residual safety clearance shall be at least 100 mm, and
 - c) the residual freeboard shall not be negative.
3. The righting lever of static stability shall:
 - a) reach its maximum value h_{max} at a heeling angle φ_{max} of 25° or over;
 - b) amount to at least 0,20 m at a heeling angle of 30° or over;
 - c) be positive at a heeling angle of up to 60°.
4. The area A under the curve of the righting levers shall not be less than
 - a) 0,055 m · rad up to 30°;
 - b) 0,09 m · rad up to 40° or at the angle φ_f at which an unprotected opening reaches the water surface and which is less than 40°.

Between

- c) 30° and 40°, or
- d) 30° and the angle φ_f at which an unprotected opening reaches the water surface and which is less than 40°,

this area shall not be less than $0,03 m \cdot rad$.

Article 20.04 ***Shipbuilding and mechanical requirements***

1. By way of derogation from Article 6.01(3), and Article 10.01(3), the equipment must be designed for permanent lists of up to 20°.
2. By way of derogation from Article 19.06(5)(a) and Article 19.06(9)(b), the inspection body may, in the case of passenger sailing vessels not more than 25 m long, authorise a clear width of less than 0,80 m for connecting corridors and companionways. However, the clear width shall be at least 0,60 m.
3. By way of derogation from Article 19.06(10)(a), the inspection body may, in specific cases, authorise the use of removable guard rails in areas where this is necessary for controlling the sails.
4. Within the meaning of Article 19.07, sails rank as a main propulsion system.
5. By way of derogation from Article 19.15(6)(c), the height of the lower edge of the door opening may be reduced to 0,20 m above the floor of the passenger area. Once opened, the door shall close and lock automatically.
6. If there is a possibility of the propeller idling while the vessel is under sail, any endangered parts of the propulsion system shall be protected against potential damage.

Article 20.05 ***Rigging in general***

1. The parts of the rigging shall be arranged in such a way as to prevent unacceptable chafing.
2. If a material other than wood is used or if special types of rigging are used, such a design shall guarantee equivalent levels of safety with the dimensions and strength values laid down in this Chapter.

As proof of sufficient strength:

- a) a strength calculation shall be carried out; or
- b) a certificate has been obtained from a recognised classification society; or
- c) dimensioning shall be based on the procedures set out in a recognised regulatory framework (e.g. Middendorf, Kusk-Jensen).

The proof shall be presented to the inspection body.

Article 20.06 ***Masts and spars in general***

1. All spars shall be made of high-quality material.
2. Wood for masts shall:
 - a) be free of knot concentrations;
 - b) be free of sapwood within the required dimensions;
 - c) as far as possible be straight-grained;
 - d) contain as little as possible twisted growth.
3. If the chosen timber is either pitch pine or Oregon pine of quality level 'clear and better', the diameters in the tables reproduced in Articles 20.07 to 20.12 can be reduced by 5 %.
4. If the timbers used for masts, topmasts, yardarms, booms and bowsprits are not round in cross-section, such timbers must be of equivalent strength.
5. Mast pedestals, mast trunks and fastenings on deck, on floor-plates and on stem or stern shall be constructed in such a way that they can either absorb the forces they are subjected to or transfer them to other connected parts of the structure.
6. Depending on the stability of the vessel and the external forces it is subjected to and also the distribution of the available sail area, the inspection body may, on the basis of the dimensions laid down in Articles 20.07 to 20.12, allow reductions in the cross-sections of the spars and, where appropriate, of the rigging. Proof shall be submitted in accordance with Article 20.05(2).
7. If the vessel's period of oscillation/period of roll, in seconds, is less than three quarters of its breadth, in metres, the dimensions set out in Articles 20.07 to 20.12 shall be increased. Proof shall be submitted in accordance with Article 20.05(2).
8. In the tables reproduced in Articles 20.07 to 20.12 and 20.14, possible intermediate values shall be interpolated.

Article 20.07 ***Special provisions for masts***

1. Wooden masts shall meet the following minimum requirements:

Length ¹ [m]	Diameter on deck [cm]	Diameter on the cross-tree [cm]	Diameter on the mast cap [cm]
10	20	17	15
11	22	17	15
12	24	19	17
13	26	21	18
14	28	23	19
15	30	25	21
16	32	26	22
17	34	28	23
18	36	29	24
19	39	31	25

¹ Distance from the cross-tree to the deck.

Length ¹ [m]	Diameter on deck [cm]	Diameter on the cross-tree [cm]	Diameter on the mast cap [cm]
20	41	33	26
21	43	34	28
22	44	35	29
23	46	37	30
24	49	39	32
25	51	41	33

If a mast has two yards, the diameters shall be increased by at least 10 %.

If a mast has more than two yards, the diameters shall be increased by at least 15 %.

In the case of masts fitted through the deck, the diameter at the mast foot shall be at least 75 % of the diameter of the mast at deck level.

- Mast fittings, mast bands, cross-trees and mast caps shall be sufficiently strongly dimensioned and attached.

Article 20.08 ***Special provisions for topmasts***

- Wooden topmasts shall meet the following minimum requirements:

Length ¹ [m]	Diameter at the foot [cm]	Half-length diameter [cm]	Diameter at fitting ² [cm]
4	8	7	6
5	10	9	7
6	13	11	8
7	14	13	10
8	16	15	11
9	18	16	13
10	20	18	15
11	23	20	16
12	25	22	17
13	26	24	18
14	28	25	20
15	31	27	21

If square sails are attached to a topmast, the dimensions set out in the table shall be increased by 10 %.

¹ Total length of the topmast, without the masthead.

² Diameter of the topmast at the level of the masthead fitting.

2. The overlap between the topmast and the mast shall be at least 10 times the required foot diameter of the topmast.

Article 20.09
Special provisions for bowsprits

1. Wooden bowsprits shall meet the following minimum requirements:

Length ¹ [m]	Diameter at stem [cm]	Half-length diameter [cm]
4	14,5	12,5
5	18	16
6	22	19
7	25	23
8	29	25
9	32	29
10	36	32
11	39	35
12	43	39

2. The inboard section of the bowsprit shall have a length of at least four times the diameter of the bowsprit at the stem.
3. The diameter of the bowsprit at its head shall be at least 60 % of the diameter of the bowsprit at the stem.

Article 20.10
Special provisions for jib-booms

1. Wooden jib-booms shall meet the following minimum requirements:

Length ² [m]	2	3	4	5	6	7	8	9	10
Diameter at the stem [cm]	7	10	14	17	21	24	28	31	35

2. The diameter of the jib-boom at its head shall be at least 60 % of the diameter at the stem.

¹ Total length of the bowsprit.

² Total length of the jib-boom.

Article 20.11 ***Special provisions for main booms***

1. Wooden main booms shall meet the following minimum requirements:

Length ¹ [m]	5	6	7	8	9	10	11	12	13	14	15	16
Diameter [cm]	14	15	16	17	18	20	21	23	24	25	26	27

2. The diameter at the swivel pin shall be at least 72 % of the diameter specified in the table.
3. The diameter at the clew shall be at least 85 % of the diameter specified in the table.
4. Measured from the mast, the greatest diameter shall be at two thirds of the length.
5. Where:
- a) there is an angle of less than 65° between the main boom and the after leech and the main sheet is attached to the end of the boom, or
 - b) the attachment point of the sheet is not abreast of the clew,

The inspection body may, according to Article 20.05(2), require a greater diameter.

6. For sail areas of less than 50 m², the inspection body may authorise reductions in the dimensions set out in the table.

Article 20.12 ***Special provisions for gaffs***

1. Wooden gaffs shall meet the following minimum requirements:

Length ² [m]	4	5	6	7	8	9	10
Diameter [cm]	10	12	14	16	17	18	20

2. The unsupported length of the gaff shall be not more than 75 %.
3. The breaking strength of the crowfoot shall be at least equal to 1,2 times the breaking strength of the peak halyard.
4. The top angle of the crowfoot shall be a maximum of 60°.
5. If, by way of derogation from (4), the top angle of the crowfoot is greater than 60°, the tensile strength shall be adjusted to accommodate the forces that will then occur.
6. For sail areas of less than 50 m², the inspection body may authorise reductions in the dimensions set out in the table.

¹ Total length of the main boom.

² Total length of the gaff.

Article 20.13

General provisions for standing and running rigging

1. Standing and running rigging shall comply with the strength requirements set out in Articles 20.14 and 20.15.
2. Wire cable connections may take the form of:
 - a) splicings,
 - b) compression sleeves, or
 - c) sealing sleeves.
 Splicings shall be marled and ends shall be whipped.
3. Eye splices shall be provided with thimbles.
4. Ropes shall be routed in such a way as not to obstruct entrances and companionways.

Article 20.14

Special provisions for standing rigging

1. Forestays and shrouds shall meet the following minimum requirements:

Mast length ¹ [m]	11	12	13	14	15	16	17	18
Tensile strength of the forestay [kN]	160	172	185	200	220	244	269	294
Tensile strength of the shrouds [kN]	355	415	450	485	525	540	630	720
Number of shroud cables and ropes per side	3	3	3	3	3	3	4	4

2. Backstays, topmasts, flying jib-stays, jib-booms and bowsprit shrouds shall meet the following minimum requirements:

Mast length ² [m]	<13	13-18	>18
Tensile strength of the backstay [kN]	89	119	159
Tensile strength of the topmast [kN]	89	119	159
Length of topmast [m]	<6	6-8	>8
Tensile strength of the flying jib-stay [kN]	58	89	119
Length of jib-boom [m]	<5	5-7	>7
Tensile strength of the bow sprit shrouds [kN]	58	89	119

¹ Distance from the top or cross-tree to the deck.

² Distance from the top or cross-tree to the deck.

3. The preferred rope design shall be based on Rope Construction Method 6 × 7 FE in the strength class 1550 N/mm². Alternatively, at the same strength class, Construction Method 6 × 36 SE or 6 × 19 FE may be used. Because of the higher elasticity of Construction Method 6 × 19, the tensile strengths given in the table shall be increased by 10 %. Use of a different rope design shall be permitted provided it has comparable properties.
4. If rigid rigging is used, the tensile strengths shown in the table shall be increased by 30 %.
5. For rigging, only approved forks, round eyes and bolts may be used.
6. Bolts, forks, round eyes and turnbuckles shall be capable of being properly secured.
7. The tensile strength of the bobstay shall be at least 1,2 times the tensile strength of the respective jib-stay and flying jib-stay.
8. For vessels with less than 30 m³ water displacement, the inspection body may permit the reductions in tensile strengths shown in the table set out below:

Water displacement divided by the number of masts [m ³]	Reduction [%]
>20 to 30	20
10 to 20	35
< 10	60

Article 20.15
Special provisions for running rigging

1. For running rigging, fibre ropes or steel wire ropes shall be used. The minimum tensile strength and the diameter for running rigging shall, in relation to the sail area, meet the following minimum requirements:

Type of running rigging	Rope material	Sail area [m ²]	Minimum tensile strength [kN]	Diameter of rope [mm]
Staysail halyards	Steel wire	up to 35	20	6
		> 35	38	8
	Fibre (polypropylene - PP)	Rope diameter of at least 14 mm and one rope sheave for every 25 m ² or part thereof		
Gaff sail halyards Top sail halyards	Steel wire	up to 50	20	6
		> 50 to 80	30	8
		> 80 to 120	60	10
		>120 to 160	80	12
	Fibre (PP)	Rope diameter of at least 18 mm and one rope sheave for every 30 m ² or part thereof		

Type of running rigging	Rope material	Sail area [m ²]	Minimum tensile strength [kN]	Diameter of rope [mm]
Staysail sheets	Fibre (PP)	up to 40	14	
		> 40	18	
	For sail areas of more than 30 m ² , the sheet shall take the form of a tackle or shall be capable of being operated by a winch			
Gaff-/Top-sail sheets	Steel wire	< 100	60	10
		100 to 150	85	12
		> 150	116	14
	For top sail sheets, elastic connection elements (fore runners) are necessary.			
Fibre (PP)	Rope diameter of at least 18 mm and at least three rope sheaves. Where the sail area is greater than 60 m ² , one rope sheave per 20 m ²			

- Running rigging forming part of the staying shall have a tensile strength which corresponds to that of the respective stay or shrouds.
- If materials other than those stated in (1) are used, the strength values given in the table in (1) shall be complied with.

Fibre ropes of polyethylene shall not be used.

Article 20.16 ***Fittings and parts of the rigging***

- If steel wire ropes or fibre ropes are used, the diameters of the rope sheaves (measured from centre of rope to centre of rope) shall meet the following minimum requirements:

Steel wire [mm]	6	7	8	9	10	11	12
Fibre [mm]	16	18	20	22	24	26	28
Rope sheave [mm]	100	110	120	130	145	155	165

- By way of derogation from (1), the diameter of the rope sheaves may be equal to six times the diameter of the steel wire, provided that the steel wire does not constantly run over sheaves.
- The tensile strength of the fittings (e.g. forks, round eyes, turnbuckles, eye-plates, bolts, rings and shackles) shall be compatible with the tensile strength of the standing or running rigging that is attached to them.
- The fastenings of stay and shroud futtocks shall be designed to take up the forces they are subjected to.
- Only one shackle, along with the relevant stay or shroud, may be attached to each eye.
- Blocks of halyards and topping lifts shall be securely fastened to the mast, and the revolving crowfeet used for this purpose shall be in good condition.
- Attachments of eye-bolts, cleats, belaying pins and fife-rails shall be designed to cope with the forces they are subjected to.

Article 20.17
Sails

1. It shall be ensured that sails can be taken in simply, swiftly and safely.
2. The sail area shall be appropriate for the type of vessel and the water displacement.

Article 20.18
Equipment

1. Vessels that are fitted with a jib-boom or a bowsprit shall have a jib-net and an adequate number of appropriate holding and tensioning devices.
2. The equipment according to (1) may be dispensed with if the jib-boom or bowsprit is equipped with a hand becket and a foot rope adequately dimensioned to allow for the attachment of a safety harness to be carried on board.
3. For work on the rigging, a boatswain's chair shall be provided.

Article 20.19
Testing

1. The rigging shall be tested by the inspection body every 2,5 years. As a minimum, the test shall cover the following:
 - a) the sails, including leeches, clews and reef eyes;
 - b) the state of the masts and spars;
 - c) the state of the standing and running rigging together with cable wire connections;
 - d) facilities for taking in the sail swiftly and safely;
 - e) the secure fastening of blocks of halyards and topping lifts;
 - f) the fastening of mast trunks and other fastening points for standing and running rigging that are attached to the vessel;
 - g) the winches for operating the sails;
 - h) other facilities fitted for the purposes of sailing, such as lee-boards and the fittings for operating them;
 - i) the measures taken to prevent the chafing of the spars, the running and standing rigging and the sails;
 - j) the equipment according to Article 20.18.
2. That part of the wooden mast passing through the deck and located below the deck shall be re-examined at intervals to be determined by the inspection body, but at the very least on the occasion of each periodical inspection. The mast shall be extracted for this purpose.
3. A certificate of the last inspection carried out in accordance with (1) and issued, dated and signed by the inspection body, shall be carried on board.

CHAPTER 21
**SPECIAL PROVISIONS APPLICABLE TO CRAFT INTENDED TO FORM PART OF A
PUSHED OR TOWED CONVOY OR OF A SIDE-BY-SIDE FORMATION**

Article 21.01
Craft suitable for pushing

1. Craft which are to be used for pushing purposes shall incorporate a suitable pushing device. They shall be designed and equipped in such a way as to:
 - a) enable crews easily and safely to cross over to the pushed craft with the coupling devices connected;
 - b) enable them to occupy a fixed position in relation to the coupled craft and
 - c) prevent relative movement between the craft themselves.
2. If the craft are joined together with cables the pusher craft shall be equipped with at least two special winches or equivalent coupling devices for tensioning the cables.
3. The coupling devices shall enable a rigid assembly to be formed with the pushed craft.

Where convoys consist of a pusher craft and a single pushed craft the coupling devices may permit controlled articulation. The necessary drive units shall easily absorb the forces to be transmitted and shall be capable of being controlled easily and safely. Articles 6.02 to 6.04 shall apply *mutatis mutandis* to such drive units.

4. The collision bulkhead referred to in Article 3.03(1)(a), can be dispensed with for pushers.

Article 21.02
Craft suitable for being pushed

1. The following shall not apply to lighters without steering system, accommodation, engine or boiler rooms:
 - a) Chapters 5 to 7 and 15;
 - b) Article 8.08(2) to (8), Article 13.02 and Article 13.08(1).

If steering systems, accommodation, engine or boiler rooms are present the relevant requirements of this Standard shall apply to them.

2. In addition, ship-borne lighters whose length L does not exceed 40 m shall meet the following requirements:
 - a) collision bulkheads referred to in Article 3.03(1), can be dispensed with if their front faces are able to bear a load at least 2,5 times that set for the collision bulkheads on inland waterway vessels with the same draught and built in accordance with the requirements of a recognised classification society;
 - b) by way of derogation from Article 8.08(1), compartments of the double bottom to which access is difficult do not have to be drainable unless their volume exceeds 5 % of the water displacement of the ship-borne lighter at the maximum authorised loaded draught.
3. Craft intended for being pushed shall be fitted with coupling devices ensuring a safe connection to other craft.

Article 21.03
Craft suitable for propelling side-by-side formations

Craft intended to propel side-by-side formations shall be equipped with bollards or equivalent devices which, as a result of their number and arrangement, enable the formation to be coupled in a safe manner.

Article 21.04
Craft suitable for being propelled in convoys

Craft intended to be propelled in convoys shall be equipped with coupling devices, bollards or equivalent devices which, as a result of their number and arrangement, ensure a safe connection to other craft in the convoy.

Article 21.05
Craft suitable for towing

1. Craft intended for towing shall meet the following requirements:
 - a) The towing devices shall be arranged in such a way that their use does not compromise the safety of the craft, crew or cargo.
 - b) Tugging and towing craft shall be fitted with a tow hook which shall be capable of being released safely from the wheelhouse; this shall not apply if the design or other fittings prevent capsizing.
 - c) Towing devices shall consist of winches or a tow hook. The towing devices shall be located ahead of the propeller plane. This requirement shall not apply to craft that are steered by their propulsion units such as rudder propellers or cycloidal propellers.
 - d) By way of derogation from the requirements of (c), for craft solely giving — in accordance with the applicable navigational authority regulations of the Member States — towing assistance to motorised craft, a towing device such as a bollard or an equivalent device shall suffice. (b) shall apply *mutatis mutandis*.
 - e) Where the towing cables could snag on the stern of the vessel, deflector hoops with cable catchers shall be provided.
2. Craft of length L exceeding 86 m shall not be authorised for towing downstream.

Article 21.06
Navigation tests on convoys

1. In order to authorise a pusher, a motor cargo vessel, a motor tanker or motorised floating equipment to propel a rigid convoy, and to enter this on the inland navigation vessel certificate, the inspection body shall decide which formations are to be presented and shall conduct the navigation tests referred to in Article 5.02 with the convoy in the formation(s) applied for, which the inspection body regards to be the least favourable one(s). The requirements set out in Articles 5.02 to 5.10 shall be met by this convoy.

The inspection body shall check that the rigid connection of all craft in the convoy is maintained during the manoeuvres required by Chapter 5.

- 2 If during the navigation tests referred to in (1) there are specific installations on board the craft that are being either pushed or propelled side-by-side, such as the steering system, propulsion units or manoeuvring equipment, or articulated couplings in order to meet the requirements set out in Articles 5.02 to 5.10, the following shall be entered on the inland navigation vessel certificate for the craft propelling the convoy: formation, position, name and unique European vessel identification number of those craft which are fitted with the specific installations used.

Article 21.07

Entries on the inland navigation vessel certificate

- 1 If a craft is intended to propel a convoy, or be propelled in a convoy, its compliance with the relevant requirements as set out in Articles 21.01 to 21.06 shall be entered on the inland navigation vessel certificate.
- 2 The following information shall be entered on the inland navigation vessel certificate for the propelling craft:
 - a) the convoys and formations that have been accepted;
 - b) the types of coupling;
 - c) the maximum coupling forces determined, and
 - d) where appropriate, the minimum breaking load of the coupling cables for the longitudinal connection and also the number of cable windings.

CHAPTER 22

SPECIAL PROVISIONS APPLICABLE TO FLOATING EQUIPMENT

Article 22.01

General

For construction and equipment of floating equipment Chapters 3, 7 to 17 and 21 shall apply. Floating equipment with its own means of propulsion shall also meet the requirements of Chapters 5 and 6. Propulsion units permitting only short-haul operation shall not constitute own means of propulsion.

Article 22.02

Derogations

1.
 - a) Article 3.03(1) and (2), shall apply *mutatis mutandis*;
 - b) Article 7.02 shall apply *mutatis mutandis*;
 - c) the maximum sound pressure levels prescribed by Article 15.02(5), second sentence, may be exceeded while the floating equipment's working gear is operating, provided that, during service, nobody sleeps on board at night;
 - d) the inspection body may grant exceptions to the other requirements concerning shipbuilding, fitting out and equipment provided that equivalent safety is proven in every case.

2. The inspection body may dispense with the application of the following requirements:
 - a) Article 13.01(1), shall not apply if during operation of floating equipment that equipment can be securely anchored by means of a working anchor or piles. However, floating equipment with its own means of propulsion shall have at least one anchor meeting the requirements in Article 13.01(1), where an empirical coefficient k is taken to be equal to 45, and T is taken to be equal to the height H ;
 - b) Article 15.02(1), second part of sentence, if the accommodation can be adequately lit by means of electricity.

3. In addition, the following shall apply:
 - a) for Article 8.08(2), second sentence, the bilge pump shall be motor driven;
 - b) for Article 8.10(3), the noise may exceed 65 dB(A) at a lateral distance of 25 m from the ship's side of any stationary floating equipment while its working gear is operating;
 - c) for Article 13.03(1), at least one further portable extinguisher is required if working gear not permanently attached to the craft is placed on the deck;
 - d) for Article 17.02(2), in addition to the liquefied-gas equipment for domestic use, there may also be other liquefied-gas facilities. Those facilities and their accessories shall meet the requirements of one of the Member States.

Article 22.03

Additional requirements

1. Floating equipment on which persons are present during operation shall be fitted with a general alarm system. The alarm signal shall be clearly distinguishable from other signals and, within accommodation and at all work stations, shall produce a sound pressure level that is at least 5 dB(A) higher than the maximum local sound pressure level. It shall be possible to actuate the alarm system from the wheelhouse and the main operating stations.
2. Working equipment shall have sufficient strength to withstand the loads it is subjected to and shall meet the requirements of one of the Member States of the CCNR or of Directive 2006/42/EC¹, as amended.
3. The stability and strength of working equipment and, where appropriate, its attachments, shall be sufficient to withstand the forces resulting from the expected heel, trim and movement of the floating equipment.
4. If loads are lifted by means of hoists the maximum authorised load deriving from stability and strength shall be prominently displayed on panels on deck and at the operating stations. If the lifting capacity can be increased by connecting additional floats the values authorised both with and without these additional floats shall be clearly stated.

Article 22.04

Residual safety clearance

1. For the purposes of this Chapter and by way of derogation from Article 1.01, residual safety clearance means the shortest vertical distance between surface of the water and the lowest part of the floating equipment beyond which it is no longer watertight, taking into account trim and heel resulting from the moments referred to in Article 22.07(4) to (9).
2. The residual safety clearance is sufficient according to Article 22.07(1), for any spray-proof and weathertight aperture if it is at least 300 mm.
3. At an aperture that is not spray-proof and weathertight the residual safety clearance shall be at least 400 mm.

Article 22.05

Residual freeboard

1. For the purposes of this Chapter and by way of derogation from Article 1.01, residual freeboard means the smallest vertical distance between the surface of the water and the upper surface of the deck at its edge taking into account trim and heel resulting from the moments referred to in Article 22.07(4) to (9).
2. The residual freeboard is sufficient according to Article 22.07(1), if it is at least 300 mm.
3. The residual freeboard may be reduced if it is proven that the requirements of Article 22.08 have been met.

¹ Directive 2006/42/EC of the European Parliament and of the Council of 17 May 2006 on machinery, and amending Directive 95/16/EC (OJ L 157, 9.6.2006).

4. Where the shape of a floating object differs perceptibly from that of a pontoon, as in the case of a cylindrical floating object, or where the cross-section of a floating object has more than four sides, the inspection body may require or authorise a residual freeboard that differs from (2). This shall also apply to floating equipment consisting of several floating objects.

Article 22.06 **Heeling test**

1. The proof of stability according to Articles 22.07 and 22.08 shall be based on a heeling test that has been carried out in a proper manner.
2. If during a heeling test it is not possible to achieve adequate heeling angles, or if the heeling test causes unreasonable technical difficulties, this may be replaced by a calculation of the craft's centre of gravity and weight. The result of the weight calculation shall be checked by measuring the draught, and the difference shall not exceed $\pm 5\%$.

Article 22.07 **Proof of stability**

1. It shall be confirmed that, when taking into account the loads applied during operation of the working gear and whilst under way, the residual freeboard and the residual safety clearance are sufficient. For that purpose the sum of the trim and heeling angles shall not exceed 10° and the bottom of the float shall not emerge.
2. The proof of stability shall include the following data and documents:
 - a) scale drawings of floating objects and working gear and the detailed data relating to these that are needed to provide proof of stability, such as content of the tanks, openings providing access to the inside of the vessel;
 - b) hydrostatic data or curves;
 - c) righting lever curves for static-stability to the extent required in accordance with (5) below or Article 22.08;
 - d) description of the operating conditions together with the corresponding data concerning weight and centre of gravity, including its unladen state and the equipment situation as regards transport;
 - e) calculation of the heeling, trimming and righting moments, with a specification of the trim and heeling angles and the corresponding residual freeboard and residual safety clearances;
 - f) a compilation of the results of the calculation with a specification of the limits for operation and the maximum loads.
3. The proof of stability shall be based on at least the following load assumptions:
 - a) specific mass of the dredging products for dredgers:
 - sands and gravels: $1,5 \text{ t/m}^3$,
 - very wet sands: $2,0 \text{ t/m}^3$,
 - soil, on average: $1,8 \text{ t/m}^3$,
 - mixture of sand and water in the ducts: $1,3 \text{ t/m}^3$;

- b) for clamshell dredgers, the values given under (a) shall be increased by 15 %;
 - c) for hydraulic dredgers the maximum lifting power shall be considered.
4. The proof of stability shall take account of the moments resulting from:
- a) load;
 - b) asymmetric structure;
 - c) wind pressure;
 - d) turning whilst under way of self-propelled floating equipment;
 - e) cross current, if necessary;
 - f) ballast and provisions;
 - g) deck loads and, where appropriate, cargo;
 - h) free surfaces of liquids;
 - i) inertia forces;
 - j) other mechanical equipment.

The moments which may act simultaneously shall be added up.

5. The moment caused by the wind pressure shall be calculated in accordance with the following formula:

$$M_W = c \cdot P_W \cdot A_W \cdot \left(l_W + \frac{T}{2} \right) [kNm]$$

where:

c = shape-dependent coefficient of resistance

For frameworks $c = 1,2$ and for solid-section beams $c = 1,6$. Both values take account of gusts of wind.

The whole area encompassed by the contour line of the framework shall be taken to be the surface area exposed to the wind.

P_W = specific wind pressure; this shall uniformly be taken to be 0,25 kN/m²;

A_W = lateral plane of the vessel above the plane of draught according to the considered loading condition in [m²];

l_W = distance of the centre of gravity of the lateral plane A_W from the plane of draught according to the considered loading condition in [m].

6. In order to determine the moments due to turning whilst under way according to (4)(d) for self-propelled floating equipment, the formula set out in Article 19.03(6) shall be used.
7. The moment resulting from cross current according to (4)(e) shall be taken into account only for floating equipment which is anchored or moored across the current while operating.
8. The least favourable extent of tank filling from the point of view of stability shall be determined and the corresponding moment introduced into the calculation when calculating the moments resulting from liquid ballast and liquid provisions according to (4)(f).
9. The moment resulting from inertia forces according to (4)(i) shall be given due consideration if the movements of the load and the working gear are likely to affect stability.

10. The righting moments for floating objects with vertical side walls may be calculated using the following formula

$$M_R = 10 \cdot D \cdot \overline{MG} \cdot \sin \varphi \text{ [kNm]}$$

where:

\overline{MG} = metacentric height, in m;

φ = heeling angle in degrees.

That formula shall apply up to heeling angles of 10° or up to a heeling angle corresponding to immersion of the edge of the deck or emergence of the edge of the bottom; the smallest angle shall be decisive. The formula may be applied to slanting side walls up to heeling angles of 5°; the limit conditions set out in (3) to (9) shall also apply.

If the particular shape of the floating object(s) does not permit such simplification the righting lever curves according to (2)(c) shall be required.

Article 22.08

Proof of stability in the case of reduced residual freeboard

If a reduced residual freeboard according to Article 22.05(3), is used, it shall be proven for all operating conditions that:

- a) after correction for the free surfaces of liquids, the metacentric height is not less than 0,15 m;
- b) for heeling angles between 0° and 30°, there is a righting lever of at least

$$h = 0,30 - 0,28 \cdot \varphi_n \text{ [m]}$$

φ_n being the heeling angle from which the righting lever curve displays negative values (range of stability); it shall not be less than 20° or 0,35 rad and shall not be introduced into the formula for more than 30° or 0,52 rad, taking the radian (rad) (1° = 0,01745 rad) for the unit of φ_n ;

- c) the sum of the trim and heeling angles does not exceed 10°;
- d) a residual safety clearance meeting the requirements in Article 22.04 remains;
- e) a residual freeboard of at least 0,05 m remains;
- f) for heeling angles between 0° and 30°, a residual righting lever of at least

$$h = 0,20 - 0,23 \cdot \varphi_n \text{ [m]}$$

remains, where φ_n is the heeling angle from which the righting lever curve displays negative values; it shall not be introduced into the formula for more than 30° or 0,52 rad.

Residual righting lever means the maximum difference existing between 0° and 30° of heel between the righting lever curve and the heeling lever curve. If an opening towards the inside of the vessel is reached by the water at a heeling angle less than that corresponding to the maximum difference between the lever curves, the lever corresponding to that heeling angle shall be taken into account.

Article 22.09
Draught marks and draught scales

Draught marks in accordance with Article 4.03 and draught scales in accordance with Article 4.04 shall be affixed.

Article 22.10
Floating equipment without proof of stability

1. The application of Articles 22.04 to 22.08 may be dispensed with for floating equipment:
 - a) whose working gear can in no way alter their heeling or trim, and
 - b) where any displacement of the centre of gravity can be absolutely excluded.
2. However,
 - a) at maximum load the safety clearance shall be at least 300 mm and the freeboard at least 150 mm; and
 - b) for apertures which cannot be closed spray-proof and weathertight the safety clearance shall be at least 500 mm.

CHAPTER 23
SPECIAL PROVISIONS APPLICABLE TO WORKSITE CRAFT

Article 23.01
Operating conditions

Worksite craft designated as such in the inland navigation vessel certificate may navigate outside worksites only when unladen. That restriction shall be entered on the inland navigation vessel certificate.

For this purpose worksite craft shall have an attestation issued by the competent authority indicating the duration of works and the geographical boundaries of the worksite in which the craft may be operated.

Article 23.02
Application of Part II

Unless otherwise specified in this Chapter, the construction and equipment of worksite craft shall be in line with Chapters 3 to 17 of Part II.

Article 23.03
Derogations

1.
 - a) Article 3.03(1), shall apply *mutatis mutandis*;
 - b) Chapters 5 and 6 shall apply *mutatis mutandis* where the craft is self-propelled;
 - c) Article 13.02(2)(a) and (b), shall apply *mutatis mutandis*;
 - d) the inspection body may grant exceptions to the other requirements concerning shipbuilding, fitting out and equipment provided that equivalent safety is proven in every case.

2. The inspection body may dispense with the following provisions:
 - a) Article 8.08(2) to (8), if no crew is required;
 - b) Article 13.01(1) and (3), if the worksite craft can be securely anchored by means of working anchors or piles. However, self-propelled worksite craft shall be equipped with at least one anchor meeting the requirements set out in Article 13.01(1), where an empirical coefficient k is taken to be equal to 45, and T is taken to be equal to the height H ;
 - c) Article 13.02(1)(c), if the worksite craft is not self-propelled.

Article 23.04
Safety clearance and freeboard

1. If a worksite craft is used as a reclamation barge or a hopper barge the safety clearance outside the hold area shall be at least 300 mm and the freeboard at least 150 mm. The inspection body may permit a smaller freeboard if proof by calculation is provided that stability is sufficient for a cargo having a specific mass of 1,5 t/m³ and that no side of the deck reaches the water. The effect of liquefied cargo shall be taken into account.
2. The provisions of Articles 4.01 and 4.02 shall apply *mutatis mutandis* to worksite craft not covered by (1). The inspection body may determine values departing from the above for safety clearance and freeboard.

Article 23.05
Ship's boats

Worksite craft shall not be required to have a ship's boat where:

- a) they are not self-propelled or
- b) a ship's boat is available elsewhere on the worksite.

That derogation shall be entered on the inland navigation vessel certificate.

CHAPTER 24

SPECIAL PROVISIONS APPLICABLE TO TRADITIONAL CRAFT

Article 24.01

Application of Parts II and III

1. Traditional craft shall be built according to good shipbuilding practice in compliance with the technical conditions of the chosen historical period.

The state of the shipbuilding, fitting out and equipment of the traditional craft shall be at least in accordance with the national regulations of the Member State in which the traditional craft was originally operated at the historical date chosen.

2. All component parts, fitting out and equipment not included in the state of the shipbuilding, fitting out and equipment of the chosen time period shall meet all applicable provisions of Parts II and III of this Standard.
3. In the event of deviations from the currently applicable provisions of this Standard, the inspection body shall establish, as a balancing compensation, an equivalent level of safety in consideration of the traditional craft's technical functioning and also its visual impression. These deviations are only permissible where they are necessary due to the need to preserve the craft's historic character.

Article 24.02

Recognition and entry in the inland navigation vessel certificate

1. The recognition of a craft as a traditional craft requires
 - a) an initial inspection before an inland navigation vessel certificate is first issued or
 - b) a special inspection before issuing an amended inland vessel certificate following the conversion or the change of intended purpose of a craft to a traditional craft.
2. In addition to the regulatory documents required, the following documents shall be submitted to the inspection body with the application for inspection:
 - a) the expert report by an expert of a heritage conservation authority with corresponding expertise in the field, or by a traditional craft expert, issued in response to an inspection, which has been carried out not more than three months before the time of the application, certifying that the requirements of Article 24.01(1) are met, that suitability for a use pursuant to Article 1.01(1.29) is assumed and that the craft is correspondingly worthy of being preserved;
 - b) the operations concept;
 - c) a safety concept based on the operations concept pursuant to (b);
 - d) the traditional craft's documentation, consisting of the following parts:
 - aa) details of the state of shipbuilding, fitting out and equipment of the craft presented for inspection, by means of relevant descriptions, drawings, photographs and other documentation;
 - bb) list of the requirements applicable at the chosen historical date and copies thereof as far as these are necessary for justification of deviations from the requirements of parts II and III of this Standard;

- cc) proof that the state of shipbuilding, fitting out and equipment is appropriate to operate the craft as a traditional craft;
- dd) drawings, plans, calculations and evidence pursuant to this Standard. These have to comply with the state applicable of the craft at the time of the submission of the application;
- ee) list of deviations in the state of shipbuilding, fitting out and equipment pursuant to the details in (aa) from the requirements of this Standard applicable at the time of the submission of the application;
- ff) data on the traditional craft's crew at the chosen historic time period.

3. The applicant applies for the historical date for the traditional craft; this date must not be chosen before the date when the craft was first put into service. In the case of a replica of a traditional craft, the historical date can be seen from the expert report in accordance with (2)(a).

4. On the basis of the above documentation and the inspection in accordance with (1), the inspection body assess conformity in accordance with Article 1.01(1.29) and Article 24.01 and the recognition as "traditional craft" is entered in item 2 of the inland navigation vessel certificate.

The assessment of conformity may not take place against the judgement of the traditional craft expert and against the expert report pursuant to (2)(a).

5. In addition to the entry 'traditional craft', the 'traditional craft' Annex shall be issued pursuant to the model of Annex 3, Section V. The following entry shall be entered in item 52 of the inland navigation vessel certificate:

'See Traditional Craft Annex.'

6. If non-conformities to the version of this Standard applicable at the time of submission of the application are detected in the documentation referred to in (2)(d)(ee), or during the inspection referred to in (1), then

- a) only the crew or persons who are on official business on board can remain on the craft while under way, and
- b) operation of machines or mechanically-driven equipment on board which are easily accessible is permitted only if no one is on board, except the crew or persons who are on official business on board.

The following entry shall be entered in item 52 of the inland navigation vessel certificate.

'Persons other than the crew or persons who are on official business on board may only stay on board when the craft is securely moored and freely-accessible machines and mechanically-driven equipment are not in operation'.

Article 24.03
Other provisions and requirements

1. The inspection body shall determine, in accordance with the operations and safety concepts in accordance with Article 24.02(2)(b) and (c), as well as the state of the shipbuilding, fitting out and equipment of the traditional craft:
 - a) the minimum manning level and the crew's qualifications;
 - b) the permissible number of persons which may be reduced to the minimum manning level;
 - c) restrictive conditions for the stay of persons other than crew members on board;
 - d) the permissible load which may be reduced to 'zero';
 - e) the permissible area of operation;
 - f) the meteorological restrictions;
 - g) the nautical restrictions;
 - h) further restrictive conditions.

2. In the case of periodic inspections, the inspection body may modify the conditions in accordance with Article 24.03(1) and Article 24.01(3) on the basis of the further development of the technical regulations of this Standard. These modifications shall be entered in the traditional craft annex of the inland navigation vessel certificate.

CHAPTER 25
SPECIAL PROVISIONS APPLICABLE TO SEA-GOING VESSELS

Article 25.01
Provisions for the Rhine (Zone R)

1. Seagoing vessels navigating on the Rhine shall comply with the relevant national and international provisions concerning technical requirements as regards construction, equipment and the seagoing vessels' environment and must be able to corroborate this by means of the necessary certificates.
2. Seagoing vessels shall comply with the following provisions of this Standard in addition to the requirements specified in (1):
 - a) Chapter 5;
 - b) to Chapter 6:
Article 6.01(1) and Article 6.02(1) and (2);
 - c) to Chapter 7:
Article 7.01(2), Article 7.02(1) and (3), 1st and 2nd subparagraphs, Article 7.04(11)(e), Article 7.05(2),
Article 7.13 for sea-going vessels designed for radar navigation by one person;
 - d) to Chapter 8
Article 8.03(2) for sea-going vessels when an automatic shut-off device can be switched off from the steering position; Article 8.08(10), Article 8.09(1) and (2) and Article 8.10.
Locking the closures in position prescribed in Article 8.08(10) shall be regarded as equivalent to sealing the closures of the bilge system through which the oily water can be pumped out of the vessel. The required key or keys must be kept in a central location which shall be marked accordingly.
An oil discharge monitoring and control system complying with Regulation 16 of MARPOL 73/78 shall be deemed equivalent to locking the closures in position prescribed in Article 8.08(10). The existence of the monitoring and control system must be attested by an international oil pollution prevention (IOPP) certificate that complies with MARPOL 73/78.
If the IOPP attestation reveals that the vessel is equipped with collecting tanks enabling all the oily water and oily residues to be retained on board, Article 8.09(2) must be deemed to have been complied with;
 - e) to Chapter 10:
Article 10.17;
 - f) to Chapter 13:
Articles 13.01 and 13.02(1);
 - g) Chapter 21,
for sea-going vessels permitted to form part of a convoy;
 - h) Chapter 27:
Chapter 27 shall be deemed to have been complied with when stability complies with current IMO Resolutions, the corresponding stability-related documents have been endorsed by the competent authority and the containers are secured in the customary maritime navigation manner.

CHAPTER 26
SPECIAL PROVISIONS APPLICABLE TO RECREATIONAL CRAFT

Article 26.01
Application of Part II

1. Recreational craft shall meet the following requirements:
 - a) from Chapter 3:
Article 3.01, Article 3.02(1)(a) and (2), Article 3.03(1)(a) and (6), and Article 3.04(1);
 - b) from Chapter 5:
Article 5.01(1) and (3), Article 5.02, Article 5.03, Article 5.05 to Article 5.10;
 - c) from Chapter 6:
Article 6.01(1), and Article 6.08;
 - d) from Chapter 7:
Article 7.01(1) and (2), Article 7.02, Article 7.03(1) and (2), Article 7.04(1), Article 7.04(11)(e), Article 7.05(2),
Article 7.06(3) in case of recreational craft for which the applicable navigational authority regulations for certain areas of navigation in the Member States specify that they must be equipped with Inland AIS equipment,
Article 7.13;
 - e) from Chapter 8:
Article 8.01(1) and (2), Article 8.02(1) and (2), Article 8.03(1) and (2), Article 8.04, Article 8.05(1) to (5),
Article 8.05(6) or as an alternative with the technical requirements of Standard EN ISO 10088 : 2023,
Article 8.05(7) to (10), Article 8.06, Article 8.07, Article 8.08(1), (2), (5), (7) and (10), Article 8.09(1), and Article 8.10;
 - f) Chapter 9;
 - g) from Chapter 10:
Article 10.01(1), *mutatis mutandis*;
 - h) from Chapter 13:
Article 13.01(2), (3) and (5) to (14), Article 13.02(1)(a) to (c), and (3)(a) and (e) to (h),
Article 13.03(1)(a), (b) and (d) however, there shall be at least two fire extinguishers on board,
Article 13.03(2) to (6), Article 13.04, Article 13.05 and
Article 13.08 however non-inflatable lifejackets are also admissible for adults;
 - i) Chapter 16;
 - j) Chapter 17;
 - k) from Chapter 21:
Article 21.02(3), Article 21.04 and Article 21.07.

2. For recreational craft subject to Directive 2013/53/EU¹ (or previously Directive 94/25/EC), only the following requirements apply:
- a) Article 6.08;
 - b) from Chapter 7:
 - Article 7.01(2), Article 7.02, Article 7.03(1),
 - Article 7.06(3) in case of recreational craft for which the applicable navigational authority regulations for certain areas of navigation in the Member States specify that they must be equipped with Inland AIS equipment, and
 - Article 7.13;
 - c) from Chapter 8:
 - Article 8.01(2), Article 8.02(1), Article 8.03(2), Article 8.05(5), and Article 8.08(2);
 - d) from Chapter 13:
 - Article 13.01(2), (3), (6) and (14), Article 13.02(1)(b) and (c), (3)(a) and (e) to (h), Article 13.03(1)(b) and (d),
 - Article 13.03 (2) to (6) as an alternative with the technical requirements of Standard ISO 9094 : 2022, and
 - Article 13.08, however
 - aa) non-inflatable lifejackets are also admissible for adults;
 - bb) the requirement for three lifebuoys under Article 13.08(1) may be reduced to two;
 - cc) horseshoe lifebuoys are permitted;
 - e) Chapter 16;
 - f) from Chapter 17:
 - aa) Article 17.12;
 - bb) Article 17.13; the testing after putting into service of the liquefied gas installation shall be carried out in accordance with the requirements of Directive 2013/53/EU, and an inspection attestation shall be submitted to the inspection body;
 - cc) Article 17.14 and Article 17.15; the liquefied gas installation shall be in accordance with the requirements of Directive 2013/53/EU;
 - dd) Chapter 17 entirely, if the liquefied gas installation is fitted after placing on the market of the recreational craft.

¹ Directive 2013/53/EU of the European Parliament and of the Council of 20 November 2013 on recreational craft and personal watercraft and repealing Directive 94/25/EC (OJ L 354, 28.12.2013).

CHAPTER 27

SPECIAL PROVISIONS APPLICABLE TO VESSELS CARRYING CONTAINERS

Article 27.01

General

1. The provisions of this Chapter shall apply to vessels carrying containers where stability documents are required in accordance with applicable navigational authority regulations of the Member States

Stability documents shall be checked, or submitted elsewhere for checking, and duly stamped by an inspection body.

2. Stability documents shall provide the boatmaster with comprehensible information on vessel stability for each loading condition.

Stability documents shall include at least the following:

- a) information on the permissible stability coefficients, the permissible \overline{KG} - values or the permissible heights for the centre of gravity of the cargo;
 - b) data concerning spaces that can be filled with ballast water;
 - c) forms for checking stability;
 - d) instructions for use or an example of a calculation for use by the boatmaster.
3. For vessels where it is optional whether containers are carried non-secured or secured, separate calculation methods shall be applied for proof of stability both for transport of non-secured and secured cargoes of containers.
 4. A cargo of containers shall only be considered to be secured if each individual container is firmly attached to the hull of the vessel by means of container guides or securing equipment and its position cannot alter during the voyage.

Article 27.02

Limit conditions and method of calculation for proof of stability for the transport of non-secured containers

1. All methods of calculating vessel stability in the case of non-secured containers shall meet the following limit conditions:
 - a) Metacentric height \overline{MG} shall be not less than 1,00 m.
 - b) Under the joint action of the centrifugal force resulting from the vessel's turning, wind pressure and the free surfaces of liquids, the heeling angle shall not exceed 5° and the edge of the deck shall not be immersed.
 - c) The heeling lever resulting from the centrifugal force caused by the vessel's turning shall be determined in accordance with the following formula:

$$h_{KZ} = c_{KZ} \cdot \frac{v^2}{L_{WL}} \cdot \left(\overline{KG} - \frac{T'}{2} \right) [m]$$

where:

- c_{KZ} parameter ($c_{KZ} = 0,04$) [s^2/m];
 v the maximum speed of the vessel in relation to the water [m/s];
 \overline{KG} height of centre of gravity of the laden vessel above its base [m];
 T' draught of the laden vessel [m].

- d) The heeling lever resulting from the wind pressure shall be determined in accordance with the following formula:

$$h_{KW} = c_{KW} \cdot \frac{A'}{D'} \cdot \left(l_W + \frac{T'}{2} \right) [m]$$

where:

- c_{KW} parameter ($c_{KW} = 0,025$) [t/m^2];
 A' lateral plane above water with the vessel laden [m^2];
 D' displacement of the laden vessel [t];
 l_W height of the centre of gravity of the lateral plane A' above the respective waterline [m];
 T' draught of the laden vessel [m].

- e) The heeling lever resulting from the free surfaces of rainwater and residual water within the hold or the double bottom shall be determined in accordance with the following formula:

$$h_{KfO} = \frac{c_{KfO}}{D'} \cdot \sum (b \cdot l \cdot (b - 0,55 \sqrt{b})) [m]$$

where:

- c_{KfO} parameter ($c_{KfO} = 0,015$) [t/m^2];
 b width of hold or section of the hold in question [m];*
 l length of hold or section of the hold in question [m];*
 D' displacement of the laden vessel [t].

- f) Half of the fuel and fresh water supply shall be taken into account for each loading condition.

2. The stability of a vessel carrying non-secured containers shall be considered to be sufficient if the effective \overline{KG} does not exceed the \overline{KG}_{zul} resulting from the following formulae. The \overline{KG}_{zul} shall be calculated for various displacements covering the entire range of draughts:

* The hold sections providing free surfaces that are exposed to water arise from the longitudinal and/or transverse water-tight compartmentalisation that forms independent sections.

a)

$$\overline{KG}_{zul} = \frac{\overline{KM} + \frac{B_{WL}}{2F} \cdot \left(Z \cdot \frac{T_m}{2} - h_{KW} - h_{kFO} \right)}{\frac{B_{WL}}{2F} \cdot Z + 1} [m]$$

No value less than 11,5 (11,5 = 1/tan5°) shall be taken for $\frac{B_{WL}}{2F}$

b) $\overline{KG}_{zul} = \overline{KM} - 1,00 [m]$

The lowest value of \overline{KG}_{zul} in accordance with formula (a) or (b) shall be decisive.

Within the formulae:

\overline{KG}_{zul} maximum permissible height of the laden vessel's centre of gravity above its base [m];

\overline{KM} height of the metacentre above the base [m] in accordance with the approximation formula in (3);

F respective effective freeboard at $\frac{1}{2} L$ [m];

Z parameter for the centrifugal force resulting from turning

$$Z = \frac{(0,7 \cdot v)^2}{9,81 \cdot 1,25 L_{WL}} = 0,04 \cdot \frac{v^2}{L_{WL}}$$

v maximum speed of the vessel in relation to the water [m/s];

T_m respective average draught [m];

h_{KW} heeling lever resulting from lateral wind pressure according to (1)(d) [m];

h_{kFO} sum of the heeling levers resulting from the free surfaces of liquids according to (1)(e) [m].

3. Approximation formula for \overline{KM} :

Where no sheet of hydrostatic curves is available the value \overline{KM} for the calculation in accordance with (2) and Article 27.03 (2), may be determined by the following approximation formulae:

a) for vessels in the shape of a pontoon

$$\overline{KM} = \frac{B^2_{WL}}{\left(12,5 - \frac{T_m}{H} \right) \cdot T_m} + \frac{T_m}{2} [m]$$

b) for other vessels

$$\overline{KM} = \frac{B^2_{WL}}{\left(12,7 - 1,2 \cdot \frac{T_m}{H} \right) \cdot T_m} + \frac{T_m}{2} [m]$$

Article 27.03
Limit conditions and method of calculation for proof of stability
for the transport of secured containers

1. All methods of calculating vessel stability in the case of secured containers shall meet the following limit conditions:
 - a) Metacentric height \overline{MG} shall be not less than 0,50 m.
 - b) Under the joint action of the centrifugal force resulting from the vessel's turning, wind pressure and the free surfaces of liquids, no hull opening shall be immersed.
 - c) The heeling levers resulting from the centrifugal force due to the vessel's turning, the wind pressure and the free surfaces of liquids shall be determined in accordance with the formulae referred to in Article 27.02(1)(c) to (e).
 - d) Half of the fuel and fresh water supply shall be taken into account for each loading condition.

2. The stability of a vessel carrying secured containers shall be considered to be sufficient if the effective \overline{KG} does not exceed \overline{KG}_{zul} resulting from the following formulae that has been calculated for various displacements covering the entire range of draughts.

$$a) \quad \overline{KG}_{zul} = \frac{\overline{KM} - \frac{I-i}{2\forall} \left(1 - 1,5 \frac{F}{F'}\right) + 0,75 \frac{BWL}{F'} \left(Z \cdot \frac{T_m}{2} - h_{KW} - h_{KfO}\right)}{0,75 \cdot \frac{BWL}{F'} \cdot Z + 1} [m]$$

No value less than 6,6 shall be taken for $\frac{BWL}{F'}$ and

no value less than 0 for $\frac{I-i}{2\forall} \cdot \left(1 - 1,5 \frac{F}{F'}\right)$

$$b) \quad \overline{KG}_{zul} = \overline{KM} - 0,50 [m]$$

The lowest value for \overline{KG}_{zul} in accordance with formula (a) or (b) shall be decisive.

Within these formulae, apart from the terms defined previously:

I transverse moment of inertia of water line area at T_m [m^4] (for the approximation formula see (3));

i transverse moment of inertia of the water line area parallel to the base, at height

$$T_m + \frac{2}{3} F' [m^4]$$

\forall water displacement of the vessel at T_m [m^3];

F' ideal freeboard

$F' = H' - T_m [m]$ or $F' = \frac{a \cdot BWL}{2 \cdot b} [m]$, the lowest value shall be decisive;

- a* the vertical distance between the lower edge of the opening that is first immersed in the event of heeling and the water line in the vessel's upright position [m];
- b* distance from that same opening from the centre of the vessel [m];
- H'* ideal side height $H' = H + \frac{q}{0,9 \cdot L \cdot B_{WL}}$ [m];
- q* sum of the volumes of the deckhouses, hatches, trunk decks and other superstructures up to a maximum height of 1,0 m above *H* or up to the lowest aperture in the volume under consideration, the lowest value being decisive. Parts of volumes located within a range of 0,05 *L* from the extremities of the vessel shall not be taken into account [m³].

3. Approximation formula for *I*

Where there is no sheet of hydrostatic curves available the value for the transverse moment of inertia *I* of the water line area may be calculated by the following approximation formulae:

- a) for vessels in the shape of a pontoon

$$I = \frac{B_{WL}^2 \cdot \nabla}{\left(12,5 - \frac{T_m}{H}\right) \cdot T_m} [m^4]$$

- b) for other vessels

$$I = \frac{B_{WL}^2 \cdot \nabla}{\left(12,7 - 1,2 \cdot \frac{T_m}{H}\right) \cdot T_m} [m^4]$$

Article 27.04 ***Procedure for assessing stability on board***

The procedure for assessing stability may be determined by the documents referred to in Article 27.01(2).

CHAPTER 28

SPECIAL PROVISIONS APPLICABLE TO CRAFT LONGER THAN 110 M

Article 28.01

Application of Part II

In addition to Part II and III, Articles 28.02 to 28.04 shall apply to craft whose length L exceeds 110 m.

Article 28.02

Strength

Sufficient hull strength in accordance with Article 3.02(1)(a) (longitudinal, lateral and local strength) shall be verified by a attestation issued by a recognised classification society.

Article 28.03

Buoyancy and stability

1. (2) to (10) shall apply to craft whose length L exceeds 110 m, with the exception of passenger vessels.
2. The basic values for the stability calculation, the vessel's lightweight and the location of the centre of gravity, shall be determined by means of a heeling test carried out in accordance with Annex 1 to IMO Resolution MSC.267(85)¹.
3. The applicant shall prove by a calculation that the damage stability of the vessel is appropriate. The calculation of the final state of flooding should be based on the method of 'lost buoyancy' and the intermediate states of flooding should be calculated on the basis of the method of 'added mass'. All calculations shall be carried out free to trim and sinkage.

Sufficient buoyancy and stability of the vessel in the event of flooding shall be proven with a cargo corresponding to its maximum draught and evenly distributed among all the holds and with maximum supplies and fully fuelled.

For diversified cargo, the stability calculation shall be performed for the most unfavourable loading condition. This stability calculation shall be carried on board.

For this purpose, mathematical proof of sufficient stability shall be determined for the intermediate stages of flooding (25 %, 50 % and 75 % of final stage of flooding, and, where appropriate, for the stage immediately prior to transverse equilibrium) and for the final stage of flooding, in the loading conditions specified above.

4. The following assumptions shall be taken into consideration for the damaged condition:
 - a) Extent of side damage:
 - longitudinal extent: at least $0,10 L$,
 - transverse extent: 0,59 m,
 - vertical extent: from the bottom upwards without limit.

¹ MSC.267(85) adopted on 4 December 2008 - International Code on Intact Stability.

- b) Extent of bottom damage:
 longitudinal extent: at least $0,10 L$,
 transverse extent: 3,00 m,
 vertical extent: from the base 0,39 m upwards, the sump excepted.
- c) Any bulkheads within the damaged area shall be assumed damaged, which means that the subdivision shall be chosen so that the vessel remains afloat after the flooding of two or more adjacent compartments in the longitudinal direction. For the main engine room only the one compartment standard need be taken into account, i.e. the end bulkheads of the engine room shall be assumed as not damaged.
 For bottom damage, adjacent athwart ship compartments shall also be assumed as flooded.
- d) Permeability
 Permeability shall be assumed to be 95 %.
 If a calculation proves that the average permeability of a compartment is less than 95 %, the calculated value may be used instead.
 The values used shall not be less than:

Engine and service rooms	85 %
Cargo holds	70 %
Double bottoms, fuel tanks, ballast tanks, etc. depending on whether, according to their function, they have to be assumed as full or empty for the vessel floating at the maximum permissible draught	0 or 95 %.

- e) The calculation of free surfaces effect in intermediate stages of flooding shall be based on the gross surface area of the damaged compartments.
5. For all intermediate stages of flooding referred to in (3), the following criteria shall be met:
- The heeling angle φ at the equilibrium position of the intermediate stage in question shall not exceed 15° (5° where containers are not secured).
 - Beyond the heel in the equilibrium position of the intermediate stage in question, the positive part of the righting lever curve shall display a righting lever value of $GZ \geq 0,02 m$ ($0,03 m$ where containers are not secured) before the first unprotected opening becomes immersed or a heeling angle φ of 27° is reached (15° where containers are not secured).
 - Non-watertight openings shall not be immersed before the heel in the equilibrium position of the intermediate stage in question has been reached.
6. During the final stage of flooding, the following criteria shall be met:
- The lower edge of non-watertight openings (e.g., doors, windows, access hatches) shall be not less than 0,10 m above the damaged waterline.
 - The heeling angle φ at the equilibrium position shall not exceed 12° (5° where containers are not secured).

- c) Beyond the heel in the equilibrium position of the intermediate stage in question, the positive part of the righting lever curve shall display a righting lever value of $GZ_R \geq 0,05 \text{ m}$ and the area under the curve shall reach at least $0,0065 \text{ m} \cdot \text{rad}$ before the first unprotected opening becomes immersed or a heeling angle φ of 27° (10° where containers are not secured) is reached.

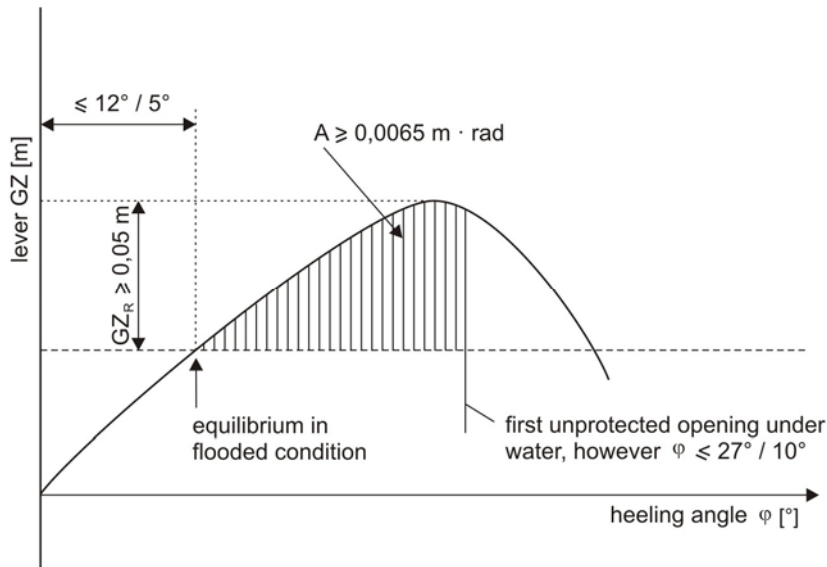

- d) If non-watertight openings are immersed before the equilibrium position is reached, the rooms affording access shall be deemed flooded for the purposes of the damage stability calculation.
7. If cross-flood openings to reduce asymmetrical flooding are provided, the following conditions shall be met:
- for the calculation of cross-flooding, IMO Resolution A.266 (VIII) shall be applied;
 - they shall be self-acting;
 - they shall not be equipped with shut-off devices;
 - the total time allowed for equalisation shall not exceed 15 minutes.
8. If openings through which undamaged compartments may additionally become flooded are capable of being closed watertight, the shut-off devices shall bear the following readily legible instruction on both sides:
- 'Close immediately after passage'.
9. The proof by calculation in accordance with (3) to (7) shall be considered to have been provided if damage stability calculations in accordance with Part 9 of the ADN are produced with a positive result.
10. Where necessary in order to meet the requirements in (3), the plane of maximum draught shall be re-established.

Article 28.04 ***Additional requirements***

1. Craft whose length L exceeds 110 m shall:
 - a) be fitted with a multi-propeller propulsion system, with at least two independent engines of equal power and a bow thruster that is controlled from the wheelhouse and is also effective when the craft is in an unladen state;
or
have a single-propeller propulsion system and a bow thruster that is controlled from the wheelhouse with its own power supply and which is also effective when the craft is in an unladen state and makes it possible for the craft to proceed under its own power in the event of a breakdown of the main propulsion system;
 - b) be fitted with a navigational radar installation, together with a rate-of-turn indicator in accordance with Article 7.06(1);
 - c) have a permanently-installed bilge pumping system in accordance with Article 8.08;
 - d) meet the requirements of Article 31.02.

2. By way of derogation from (1) and having regard to the applicable navigational authority regulations for certain areas of navigation in the Member States, for craft, except passenger vessels, with a length L of more than 110 m, which:
 - a) comply with (1)(a) to (d);
 - b) are capable of being separated, in the event of an accident, in the middle third of the craft without the use of heavy salvage equipment while the separated parts of the craft shall remain afloat after separation;
 - c) are provided with a proof that shall be carried on board and which is issued by a recognised classification society regarding the buoyancy, trim position and stability of the separate parts of the craft, indicating the degree of loading above which buoyancy of the two parts is no longer ensured;
 - d) are built as double-hull vessels in accordance with the ADN, where for motor cargo vessels sections 9.1.0.91 to 9.1.0.95, and for motor tankers paragraph 9.3.2.11.7 and sections 9.3.2.13 to 9.3.2.15 of Part 9 of the ADN shall apply;
 - e) are fitted with a multi-propeller propulsion system in accordance with (1)(a), first half sentence;

it shall be entered in item 52 of the inland navigation vessel certificate that they comply with all the requirements of (a) to (e).

3. By way of derogation from (1) and having regard to the applicable navigational authority regulations for certain areas of navigation in the Member States, for passenger vessels with a length L of more than 110 m which:
 - a) comply with (1)(a) to (d);
 - b) are built or converted for their highest class under the supervision of a recognised classification society, in which case compliance shall be confirmed by means of a attestation issued by the classification society. Maintaining class is not necessary;

- c) have a double bottom with a height of at least 600 mm and subdivision to ensure that, in the event of flooding of any two adjacent watertight compartments, the vessel does not immerse lower than the margin line and a residual safety clearance of 100 mm remains,
or
have a double bottom with a height of at least 600 mm and a double hull with a distance of at least 800 mm between the side wall of the vessel and the longitudinal bulkhead;
- d) be fitted with a multi-propeller propulsion system with at least two independent engines of equal power and a bow thruster system which can be operated from the wheelhouse and which operates longitudinally as well as transversely;
- e) allow the stern anchors to be operated directly from the wheelhouse;

it shall be entered in item 52 of the inland navigation vessel certificate that they comply with all the requirements of (a) to (e).

CHAPTER 29
SPECIAL PROVISIONS APPLICABLE TO HIGH-SPEED VESSELS

Article 29.01
General

1. High-speed vessels shall not be constructed as cabin vessels.
2. The following installations are prohibited on board high-speed vessels:
 - a) appliances fitted with wick burners according to Article 16.02;
 - b) vaporising oil burner stoves according to Articles 16.03 and 16.04;
 - c) solid-fuel heating appliances according Article 16.07;
 - d) liquefied gas installations according to Chapter 17.
3. High-speed vessels shall be constructed and classified under the supervision and in accordance with the applicable rules of a recognised classification society which has special rules for high-speed vessels. The class shall be maintained.

Article 29.02
Application of Parts II and III

1. Notwithstanding (2), Chapters 3 to 19 shall apply to high-speed vessels, with the exception of the following provisions:
 - a) Article 3.04(6), second subparagraph;
 - b) Article 8.08(2), second sentence;
 - c) Article 14.02(4), second and third sentences;
 - d) Article 15.02(4), second sentence;
 - e) Article 19.06(3)(a), second sentence.
2. By way of derogation from Article 19.02(9), and Article 19.15(6), all doors in watertight bulkheads shall be capable of being remotely controlled.
3. By way of derogation from Article 6.02(1), in case of failure or malfunctioning of the steering apparatus drive unit a second independent steering apparatus drive unit or a manually operated drive unit shall come into operation without time delay.
4. In addition to the requirements of (1) to (3), high-speed vessels shall meet the requirements of Articles 29.03 to 29.10.

Article 29.03

Seats and safety belts

Seats shall be available for the maximum number of passengers permitted on board. Seats shall be fitted with safety belts. Safety belts may be dispensed with where suitable impact protection is provided or where they are not required under Chapter 4, part 6, of the HSC Code 2000.

Article 29.04

Freeboard

By way of derogation from Article 4.02, the freeboard shall be at least 500 mm.

Article 29.05

Buoyancy, stability and subdivision

For high-speed vessels, sufficient proof shall be provided for:

- a) buoyancy and stability characteristics adequate for safety where the craft is operated in the displacement mode, both when intact and when damaged;
- b) stability characteristics and stabilising systems adequate for safety where the craft is operated in the dynamic buoyancy phase and the transition phase;
- c) stability characteristics adequate for safety where the craft is operated in the dynamic buoyancy phase and the transitional phase, and allow to transfer the craft safely to displacement mode in case of any system malfunction.

Article 29.06

Wheelhouse

1. Arrangement

- a) By way of derogation from Article 7.01(1), wheelhouses shall be arranged in such a way that the helmsman and a second member of the crew may at all times perform their tasks while the vessel is under way.
- b) The steering position shall be arranged so as to accommodate work stations for the persons mentioned in (a). The instruments for navigation, manoeuvring, monitoring and communication and other important operating controls shall be sufficiently close together to allow a second member of the crew as well as the helmsman to obtain the necessary information and to operate the controls and installations as necessary while seated. The following requirements shall apply in all cases:
 - aa) the steering position for the helmsman shall be arranged so as to allow radar navigation by one person;
 - bb) the second member of the crew shall have his own radar screen (slave) at his work station and shall be able to intervene from his work station to transmit information and control the propulsion of the vessel.
- c) The persons mentioned in (a) shall be able to operate the installations mentioned in (b) without any hindrance, including when safety belts are properly worn.

2. Unobstructed view
 - a) By way of derogation from Article 7.02(2), the area of obstructed vision for the helmsman in a seated position ahead of the vessel shall not exceed one vessel length, irrespective of the loading conditions.
 - b) By way of derogation from Article 7.02(3), the sum of the blind sector arcs from dead ahead to 22,5° abaft the beam, on either side, shall not exceed 20°. Each individual blind sector shall not exceed 5°. The sector of visibility between two blind sectors shall not be less than 10°.

3. Instruments

Panels of control and monitoring instruments for the installations mentioned in Article 29.10 shall be in separate and clearly marked positions in the wheelhouse. This shall also apply, where appropriate, to controls for launching collective life-saving equipment.

4. Lighting

Red light shall be used for areas or pieces of equipment which shall be lit during use.

5. Windows

Reflections shall be avoided. A means for avoiding dazzle by sunlight shall be provided.

6. Surface materials

The use of reflective surface materials in the wheelhouse shall be avoided.

Article 29.07 ***Additional equipment***

High-speed vessels shall have the following equipment:

- a) a navigational radar installation and rate-of-turn indicator according to Article 7.06(1); and
- b) readily accessible individual life-saving equipment installed conforming to Article 19.09(4).

Article 29.08 ***Enclosed areas***

1. General

Public rooms and accommodation and the equipment they contain shall be designed so that any person making proper use of those facilities will not suffer injury during a normal and emergency start or stop, or during manoeuvring in normal cruise and in failure or malfunction conditions.

2. Communication
 - a) For the purpose of informing passengers of safety measures, all passenger vessels shall be fitted with optic and acoustic installations visible and audible to everyone on board.
 - b) The installations described under (a) shall enable the boatmaster to give instructions to passengers.
 - c) Every passenger shall have access to instructions for emergency situations close to their seat, including a plan of the vessel showing all exits, escape routes, emergency equipment, life-saving equipment and instructions for the use of lifejackets.

Article 29.09 ***Exits and escape routes***

Exits and escape routes shall satisfy the following requirements:

- a) There shall be easy, safe and quick access from the steering position to rooms and accommodation accessible to the public.
- b) Escape routes leading to emergency exits shall be clearly and permanently marked.
- c) All exits shall be properly marked. The operation of the opening mechanism shall be obvious from the outside and the inside.
- d) The escape routes and emergency exits shall have a suitable safety guidance system.
- e) Sufficient space for a member of the crew shall be left next to exits.

Article 29.10 ***Fire protection and fire-fighting***

1. Corridors, rooms and accommodation accessible to the public and also galleys and engine rooms shall be connected to an appropriate fire alarm system. The fire alarm and the fire detection zone shall be automatically displayed by an indicator device at a location permanently manned by shipboard personnel or crew members.
2. Engine rooms shall be equipped with a permanently installed fire-fighting system according to Article 13.05.
3. Rooms and accommodation accessible to the public and their escape routes shall be equipped with a pressurised water sprinkler system according to Article 13.04. It shall be possible to drain the used water rapidly and directly to the outside.

CHAPTER 30
SPECIAL PROVISIONS APPLICABLE TO CRAFT EQUIPPED WITH
PROPULSION OR AUXILIARY SYSTEMS OPERATING ON FUELS WITH A
FLASHPOINT EQUAL TO OR LOWER THAN 55 °C

Article 30.00
Definition

For the purposes of this Chapter, the following definition shall apply:

“propulsion and auxiliary system”: any system using fuel, including fuel tanks, tank connections, fuel preparation systems, piping, valves, energy converters (such as engines, turbines or fuel cells), control, monitoring and safety systems.

Article 30.01
Scope of application

1. This chapter applies to craft with propulsion or auxiliary systems operating on fuels with a flashpoint equal to or lower than 55 °C.
2. In addition to the requirements of this chapter, Annex 8 applies, providing requirements that are specific for the storage and energy converters for the different fuels.
3. The provisions of this Chapter shall not apply to fuel cells components, which are part of auxiliary systems operating on fuels with a flashpoint equal to or lower than 55 °C and with a cumulative reference power that is less than 20 kW.

Article 30.02
General

1. Craft according to Article 30.01(1) must comply with the mitigation measures identified by the risk assessment according to Article 30.04.
2. Unless otherwise specified in Annex 8 and if necessary, derogations to Articles 8.01(3) and 8.05(1), (6), (9), (11), (12) are permitted provided that the craft meets an equivalent level of safety.

If the energy converter of the craft generates gaseous or particulate pollutants but does not fall in the scope of application of Chapter 9, the emissions of gaseous and particulate pollutants from the energy converter shall be equivalent or lower than those of the internal combustion engines referred to in Article 9.01(2). The inspection body may ask for a report which demonstrates its compliance to this requirement.

Article 30.03***Tasks of the inspection body and technical service, documentation***

1. Propulsion and auxiliary systems of craft according to Article 30.01(1) shall be constructed and installed under the supervision of the inspection body.
2. For the purpose of discharging tasks pursuant to this chapter, the inspection body may employ a technical service. The technical services shall satisfy the European Standard EN ISO 17020 : 2012. The knowledge of the technical service shall cover at least the following areas:
 - a) fuel system including tanks, heat exchangers, pipelines,
 - b) strength (longitudinal and local) and stability of the craft,
 - c) electrical installation and control, monitoring and safety systems,
 - d) ventilation system,
 - e) fire safety, and
 - f) gas warning equipment.

Manufacturers and distributors of propulsion or auxiliary systems, or parts of these systems, cannot be recognised as technical services.

The supervision and testing according to Articles 30.03(1) and 30.11 may be performed by different technical services provided that all the expertise described above is taken into account in the process.

3. Before commissioning of a propulsion or auxiliary system according to Article 30.01(1), the following documents shall be submitted to the inspection body:
 - a) a risk assessment according to Article 30.04,
 - b) a description of the propulsion or auxiliary system,
 - c) drawings of the propulsion or auxiliary system,
 - d) a diagram of the pressure and temperature within the system,
 - e) the operating manual according to 30.05(5), and
 - f) a safety rota according to Article 30.05(1).
4. The technical documentation according to (3) shall enable an assessment of whether craft, propulsion and auxiliary systems and their components comply with the applicable rules, regulations, standards applied and principles regarding safety, availability, maintainability and reliability.
5. A copy of the documents according to (3) shall be kept on board.

Article 30.04 **Risk assessment**

1. A risk assessment shall be conducted to ensure that risks arising from the use of fuels with a flashpoint equal to or lower than 55 °C affecting people on board including passengers, the environment, the structural strength and the integrity of the craft, are addressed.
2. The risk assessment shall include at least:
 - a) a hazard identification (HAZID) which combines techniques described in ISO 31010 : 2019, to identify risks, assess the risks and provide measures to eliminate or mitigate these risks. In selecting the appropriate techniques, the nature and scale of the propulsion or auxiliary system in the craft, as well as the experience of similar systems is to be considered.
 - b) the classification of hazardous areas on board, divided into zones 0, 1 and 2, according to Article 1.01(3.23).

In the light of the outcome of the hazard identification (HAZID), the inspection body may request additional risk analysis (e.g. quantitative risk analysis, failure modes, effects and (criticality) analysis (FME(C)A), hazard and operability study (HAZOP) or fire and explosion risk analysis).

3. As a minimum, the process of the hazard identification (HAZID) shall consider the following risks:
 - a) hazards associated with physical layout,
 - b) the mechanical damage to components,
 - c) influences related to operations, bunkering, purging, maintenance, cargo and weather,
 - d) electrical failures,
 - e) unintended chemical reactions,
 - f) release of toxic vapours,
 - g) self-ignition of fuels,
 - h) fire,
 - i) explosion,
 - j) temporary power outage (blackout),
 - k) flooding of water in parts of the craft which may contain fuel or hazardous vapours,
 - l) craft sinking.
4. As a minimum, the process of the hazard identification (HAZID) shall involve:
 - a) a risk assessment facilitator,
 - b) fuel related safety experts,
 - c) craft and system designers,
 - d) the shipyard or equivalent entity having an overview of the shipbuilding,
 - e) the equipment suppliers,
 - f) the future craft operator,
 - g) a boatmaster.

The inspection body must be permitted to attend as observer the risk assessment process.

-
5. The risk assessment shall ensure that risks are eliminated wherever possible. Risks which cannot be eliminated entirely are to be mitigated to an acceptable level in accordance with (6). Details of risks, and the measures by which they are mitigated, shall be documented to the satisfaction of the inspection body.
 6. Craft according to Article 30.01(1) must fulfil the following requirements:
 - a) A single failure in parts of the craft which may contain fuel or hazardous vapours, such as engines, fuel tanks and associated piping, shall not lead to an unsafe situation.
 - b) The level of safety, reliability and dependability of the craft shall be at least equivalent to that of craft with main and auxiliary machinery using fuels having a flashpoint of more than 55 °C.
 - c) The probability and consequences of fuel-related hazards shall be minimised through system design. Failure of risk-reducing measures shall lead to measures mitigating the impact on safety.
 - d) Fuel supply, storage and bunkering arrangements shall be suitable to receive and contain fuel in the required state without leakage or venting under normal operating conditions.
 - e) A fire or explosion in parts of the craft which may contain fuel or hazardous vapours shall not:
 - aa) damage or disrupt the proper functioning of equipment/systems located in any space other than that in which the incident occurs;
 - bb) damage the craft in such a way that flooding of water below the main deck or any progressive flooding occurs;
 - cc) damage work areas or accommodation in such a way that persons who stay in such areas under normal operating conditions are injured or exposed to hot temperatures or toxic substances;
 - dd) injure persons as well as prevent persons' access to life-saving appliances or impede escape routes either by physical blockage, heat or toxic substances.
 7. In agreement with the inspection body, the scope of the risk assessment can exclude concepts in whole or in part that have been previously subjected to a risk assessment, provided that:
 - a) there are no changes to the arrangements or design, location of the installation, mode of operation, type of fuels, use of surrounding spaces or to the number of persons exposed, and
 - b) mitigation measures taken as a result of previous risk assessments are included.

Article 30.05
Safety organisation

1. A safety rota shall be provided on board craft according to Article 30.01. The safety rota shall include safety instructions according to (2) and a safety plan according to (3) of the craft.
2. These safety instructions shall include information on at least the following measures:
 - a) emergency shutdown of the system,
 - b) measures in the event of accidental release of liquid or gaseous fuel, for instance during bunkering,
 - c) measures in the event of fire or other incidents on board,
 - d) measures in the event of collision,
 - e) use of safety equipment,
 - f) raising the alert, and
 - g) evacuation.
3. The safety plan shall include information on at least the following areas and equipment:
 - a) hazardous areas,
 - b) escape routes, emergency exits and gastight rooms,
 - c) life-saving equipment and ships' boats,
 - d) fire extinguishers, fire-fighting systems and sprinkler systems,
 - e) alarm systems,
 - f) emergency circuit-breakers' controls,
 - g) fire dampers,
 - h) emergency power sources,
 - i) ventilation system controls,
 - j) controls for fuel supply lines, and
 - k) safety equipment.
4. The safety rota shall:
 - a) be duly stamped by the inspection body, and
 - b) be prominently displayed at one or more appropriate points on board.
5. A detailed operating manual of the propulsion and auxiliary system shall be provided on board craft according to Article 30.01, and shall at minimum:
 - a) contain practical explanations about bunkering system, fuel containment system, fuel piping system, fuel supply system, engine or energy converter room, ventilation system, leakage prevention and control, monitoring and safety system,
 - b) describe the bunkering operations, especially valves operation, purging, inerting and gas freeing,

- c) describe the relevant method of electrical insulation during bunkering operations, and
- d) describe the details of risks identified in the risk assessment as referred to in Article 30.04 and the means by which they are mitigated.

Article 30.06 ***Marking***

Service rooms and system components shall be appropriately marked with a symbol in accordance with the corresponding figure of Annex 4, which clearly shows for what fuels they are being used, with a side length of at least 10 cm.

Article 30.07 ***Independent propulsion***

In the event of an automatic shutdown of the propulsion system or parts of the propulsion system, the craft shall be able to make steerageway under its own power.

Article 30.08 ***Fire safety***

1. Fire detection, protection and extinction measures appropriate to the hazards concerned shall be provided on board.
2. An appropriate fixed fire alarm system shall be provided for all rooms and spaces of the propulsion and auxiliary system where fire cannot be excluded.
3. An appropriate firefighting system shall be provided for all rooms and spaces of the propulsion and auxiliary system.

Article 30.09 ***Electrical installations***

1. In accordance with Article 10.04, equipment for hazardous areas shall be of an appropriate type according to zones where such equipment is installed.
2. Electrical generation and distribution systems and associated control systems shall be designed such that a single failure will not result in the release of fuel.
3. The lighting system in hazardous areas shall be divided between at least two branch circuits. All switches and protective devices shall interrupt all poles and phases and shall be located in a non-hazardous area.

Article 30.10 ***Control, monitoring and safety systems***

1. Each propulsion and each auxiliary system of craft according to Article 30.01(1) shall be fitted with its own control and monitoring system and its own safety system. These systems must be independent from each other. All elements of these systems shall be capable of being functionally tested.

2. Spaces in which the propulsion or auxiliary system is installed shall be equipped with permanently installed devices for gas detection and leakage monitoring. The number, type and redundancy of detectors in each space shall correspond to the size, layout and ventilation of the space. Permanently installed gas detectors shall be installed where gas may accumulate and in the ventilation outlets of these spaces.
3. Instrumentation devices shall be fitted to allow a local and a remote reading of essential parameters, where they are necessary to ensure a safe operation of the whole system including bunkering.

Article 30.11 ***Testing***

1. Propulsion and auxiliary systems of craft according to Article 30.01(1) shall be inspected by the inspection body:
 - a) before commissioning,
 - b) after any modification or repair, and
 - c) regularly, at least once a year.

The relevant instructions of the manufacturers shall be taken into account in the process.

2. The inspections referred to in (1)(a) and (c), must at least cover:
 - a) a check of conformity of the propulsion and auxiliary systems with the approved drawings and in the case of subsequent checks, whether alterations in the propulsion or auxiliary system were made,
 - b) if necessary, a functional test of the propulsion and auxiliary systems for all operational possibilities,
 - c) a visual check and a tightness check of all system components, in particular valves, pipelines, hoses, pistons, pumps and filters,
 - d) a visual check of the electrical and electronic appliances of the installation, and
 - e) a check of the control, monitoring, and safety systems.
3. The inspections referred to in (1)(b) shall include at least the parts of (2) which have been modified or repaired.
4. For each inspection according to (1), an inspection attestation shall be issued showing the date of inspection.

CHAPTER 31
SPECIAL PROVISIONS APPLICABLE TO VESSELS SAILING WITH MINIMUM
CREW

Article 31.01
Vessels' equipment

For craft for which a minimum crew is required compliance with, or failure to comply with, the requirements of Article 31.02 or Article 31.03 shall be entered in item 47 of the inland navigation vessel certificate by the inspection body.

Article 31.02
Standard S1

1. The propulsion systems shall be arranged in such a way that speed can be changed and the direction of the propeller thrust reversed from the steering position.

It shall be possible for the auxiliary engines needed for operational purposes to be switched on or off from the steering position, unless this is done automatically or the engines run continuously during each voyage.

2. In the critical areas of,
 - the temperature of the main-engine cooling water,
 - the lubricating-oil pressure for the main engines and transmissions,
 - the oil and air pressure of the main-engine reversing units, reversible transmissions or propellers,
 - the bilge levels in the main engine room,there shall be monitoring by means of instruments which set off optical and acoustic signals in the wheelhouse in the event of malfunction. The acoustic alarm signals may be combined in one audible warning device. They may be switched off as soon as the malfunction has been acknowledged. The visual alarm signals may only be switched off when the malfunctions which set them off have been corrected.
3. The fuel shall be supplied and main engines cooled automatically.
4. The steering system shall be able to be operated by one person, even in maximum draught, without requiring particular force.
5. It shall be possible to give the optical and acoustic signals in accordance with the applicable navigational authority regulations of the Member States, as appropriate, from the steering position of vessels under way.
6. Where there is no direct communication between the steering position and the fore-section, the aft, the accommodation and the engine rooms, a voice communication system shall be provided. For communication with the engine rooms, this may be in the form of an optical or acoustic signal.
7. The operation of cranks and similar revolving parts of lifting devices shall not require a force of more than 160 N.

8. The towing winches entered in the inland navigation vessel certificate shall be motorised.
9. The bilge and deck-wash pumps shall be motorised.
10. The principal control units and monitoring instruments shall be ergonomically arranged.
11. The equipment required under Article 6.01(1), shall be capable of being remotely operated from the steering position.

Article 31.03
Standard S2

Standard S1 and additionally equipped with:

1. For motor cargo vessels or motor tankers operating separately:
a bow thruster which can be operated from the steering position;
2. For motor cargo vessels or motor tankers propelling in side-by-side formation:
a bow thruster which can be operated from the steering position;
3. For motor cargo vessels or motor tankers propelling pushed convoys made up of the motor cargo vessel or motor tanker itself and a craft in front:
hydraulic or electrically operated coupling winches. This equipment is, however, not required if the foremost vehicle in the pushed convoy is equipped with a bow thruster which can be operated from the steering position of the pushing motor cargo vessel or motor tanker;
4. For pushers propelling a pushed convoy:
hydraulic or electric coupling winches. This equipment is, however, not required if the foremost craft in the pushed convoy is equipped with a bow thruster which can be operated from the steering position of the pusher;
5. For passenger vessels:
a bow thruster which can be operated from the steering position. This equipment is, however, not required if the propulsion system and steering system of the passenger vessel guarantee equal manoeuvrability.

PART IV TRANSITIONAL PROVISIONS

CHAPTER 32 TRANSITIONAL PROVISIONS FOR CRAFT NAVIGATING ON THE RHINE (ZONE R)

Article 32.01

Applicability of transitional provisions to craft which are already in service

1. The provisions of Articles 32.02 to 32.04 apply only to craft in possession of a valid Rhine vessel inspection certificate:
 - a) first issued according to the Rhine Vessel Inspection Regulations in force on 31 December 1994, or
 - b) renewed at least once before the 31 December 1994, or
 - c) which were under construction or undergoing conversion on 31 December 1994.
2. For craft not covered by (1), the provisions of Article 32.05 apply.

Article 32.02

Transitional provisions for craft which are already in service

1. Craft that do not fully comply with the requirements of this Standard shall:
 - a) be adapted to comply with those provisions in accordance with the transitional provisions listed in the table below, and
 - b) until their adaptation, comply with the Rhine Vessel Inspection Regulations in force on 31 December 1994.

In the event of a new inland navigation vessel certificate being issued to a craft as defined in Article 32.01(1), the Rhine vessel inspection certificate shall be submitted as corroboration, the Rhine vessel inspection certificate shall be withdrawn and the date the Rhine vessel inspection certificate was issued according to the Rhine Vessel Inspection Regulations in force on 31 December 1994 shall be entered in item 52 of the new inland navigation vessel certificate as follows:

“A Rhine vessel inspection certificate according to the Rhine Vessel Inspection Regulations in force on 31 December 1994 was issued on: ...”

2. The following definitions apply in the table below:

‘N.R.C.’: the provision does not apply to craft which are already operating, unless the parts concerned are replaced or converted, i.e. the provision applies only to Newly-built craft and to the Replacement or Conversion of the parts or areas concerned. If existing parts are replaced by replacement parts using the same technology and of the same type, this does not constitute replacement ‘R’ within the meaning of the transitional provisions.

‘Issue or renewal of the inland navigation vessel certificate’: the provision must be complied with the time of the next issue or renewal of the inland navigation vessel certificate after the date indicated.

<i>Article and paragraph</i>		<i>Content</i>	<i>Deadline and comments</i>	
CHAPTER 3				
3.03	(1)(a)	Situation of collision bulkhead	N.R.C., at the latest on renewal of the inland navigation vessel certificate after	1.1.2035
	(1)(b)	Situation of aft-peak bulkhead	N.R.C., at the latest on renewal of the inland navigation vessel certificate after	1.1.2035
	(2)	Accommodation aft of the aft-peak bulkhead	N.R.C., at the latest on renewal of the inland navigation vessel certificate after	1.1.2045
		Safety equipment aft of the aft-peak bulkhead	N.R.C., at the latest on renewal of the inland navigation vessel certificate after	1.1.2035
	(7)	Anchors not protruding in fore-sections of vessels	N.R.C., at the latest on renewal of the inland navigation vessel certificate after	1.1.2041
3.04	(6)	Exits of engine rooms	Engine rooms which were not considered as engine rooms according to Article 1.01 before 1995 must be equipped with a second exit at N.R.C., at the latest on renewal of the inland navigation vessel certificate after	1.1.2035
CHAPTER 5				
5.06	(1) 1st sentence	Minimum speed	For craft which were laid down before 1.1.1996, at the latest on renewal of the inland navigation vessel certificate after	1.1.2035
CHAPTER 6				
6.01	(1)	Manoeuvrability required by Chapter 5	N.R.C., at the latest on renewal of the inland navigation vessel certificate after	1.1.2035
6.02	(1)	Duplicated pilot valves in case of hydraulic drive units	N.R.C., at the latest on renewal of the inland navigation vessel certificate after	1.1.2020
		Separated pipework for the second drive unit in case of hydraulic drive units	N.R.C., at the latest on renewal of the inland navigation vessel certificate after	1.1.2020

<i>Article and paragraph</i>		<i>Content</i>	<i>Deadline and comments</i>	
	(3)	Manoeuvrability required by Chapter 5 ensured by second drive unit or manual drive	N.R.C., at the latest on renewal of the inland navigation vessel certificate after	1.1.2035
CHAPTER 7				
7.02	(6)	Minimal light transmission	N.R.C. for vessels with tinted windows satisfying the following conditions: <ul style="list-style-type: none"> - The windows are tinted green and exhibit a minimum light transmission of 60 %, - The wheelhouse ceiling is so designed as to preclude reflections on the windows, - Light sources in the wheelhouse must be steplessly dimmable or capable of being switched off, - All reasonable measures to avoid other reflections have been taken. 	
		Safety glass design	N.R.C.	
7.04	(2)	Control of each main engine	Unless steering positions have been designed for radar navigation by one person: N.R.C., at the latest on renewal of the inland navigation vessel certificate after	1.1.2035 if the direction of motion can be achieved directly 1.1.2010 for other engines
7.05	(1)	Navigation lights, their casings, accessories and light sources	Navigation lights, their casings, accessories, and light sources that fulfill the requirements for colour and light intensity of lights on board, and for the admission of navigation lights for navigation on the Rhine, as of 30 November 2009 may still be used.	

<i>Article and paragraph</i>		<i>Content</i>	<i>Deadline and comments</i>	
7.06	(1)	Rate-of-turn indicators, which have received an approval before 1 st January 1990	Rate-of-turn indicators, which have received an approval before 1 st January 1990 and have been installed before 1 st January 2000, may be maintained and used until renewal of the inland navigation vessel certificate after 1 st January 2015, if there is a valid installation certificate pursuant to Directive 2006/87/EC ¹ or Resolution CCNR 1989-II-35.	
		Radar navigation installations and rate-of-turn indicators which have received an approval after 1 st January 1990	Radar navigation installations and rate-of-turn indicators which have received an approval on or after 1 st January 1990, pursuant to the minimum requirements and test conditions for radar installations used for navigation on the Rhine, as well as the minimum requirements and test conditions for rate-of-turn indicators used for navigation on the Rhine, may continue to be installed then be used if there is a valid installation certificate pursuant to this Standard, Directive 2006/87/EC or Resolution CCNR 1989-II-35.	
		Radar navigation installations and rate-of-turn indicators which have received an approval after 31 st December 2006	Radar navigation installations and rate-of-turn indicators which have received an approval on or after 31 st December 2006, pursuant to the minimum requirements and test conditions of the Directive 2006/87/EC, may continue to be installed then be used if there is a valid installation certificate pursuant to this Standard or Directive 2006/87/EC.	
		Radar navigation installations and rate-of-turn indicators which have received an approval after 1 st December 2009	Radar navigation installations and rate-of-turn indicators which have received an approval on or after 1 st December 2009, pursuant to the minimum requirements and test conditions of the Resolution CCNR 2008-II-11 may continue to be installed then be used if there is a valid installation certificate pursuant to this Standard or Resolution CCNR 2008-II-11.	
		Navigational radar installations which have received an approval based on European standard 302 194-1 : 2006	Navigational radar installations which have received an approval based on European standard EN 302 194-1 : 2006 before 31 December 2023, may continue to be installed then be used if there is a valid installation certificate pursuant to this Standard.	

¹ Directive 2006/87/EC of the European Parliament and of the Council of 12 December 2006 laying down technical requirements for inland waterway vessels and repealing Council Directive 82/714/EEC (OJ L 389, 30.12.2006).

<i>Article and paragraph</i>		<i>Content</i>	<i>Deadline and comments</i>	
	(2)	Inland ECDIS equipment being operated in navigation mode	Inland ECDIS equipment with a type-approval according to Edition 2.4 (or previous ones) of the Inland ECDIS Standard, ES-RIS 2021/1 or ES-RIS 2023/1, and installed before the 1st January 2026 may continue to be used.	
			Inland ECDIS equipment with a type-approval according to Edition 2.4 (or previous ones) of the Inland ECDIS Standard, ES-RIS 2021/1 or ES-RIS 2023/1, may continue to be installed then be used, when the current edition of the presentation library and the feature catalogue as required by ES-RIS (parts I and V) has been implemented in the equipment.	
		Inland ECDIS equipment being operated in navigation mode and which have received an approval based on European standard EN 302 194-1 : 2006	Inland ECDIS equipment which has received an approval based on European standard EN 302 194-1 : 2006 before 31 December 2023, may continue to be installed then be used if there is a valid installation certificate pursuant to this Standard.	
	(3)	Inland AIS equipment	Inland AIS equipment with a type-approval according to edition 1.0 and 1.01 of the Test Standard for Inland AIS and installed before the 1 st December 2015 may continue to be used.	
			Inland AIS equipment with a type-approval according to edition 2.0 of the Test Standard for Inland AIS and installed before the 1 st January 2024 may continue to be used.	
			Inland AIS equipment with a type-approval according to edition 2021/3.0 of the Test Standard for Inland AIS, ES-RIS 2021/1 or ES-RIS 2023/1, may continue to be installed then be used.	
7.12	(4) 3 rd sentence	Roof opening used as an emergency exit	N.R.C., at the latest on renewal of the inland navigation vessel certificate after	1.1.2035
	(5) 2 nd sentence	Indications	N.R.C., at the latest on renewal of the inland navigation vessel certificate.	
	(6)	Stopping, locking and automatic deactivation	N.R.C., at the latest on renewal of the inland navigation vessel certificate after	1.1.2025

<i>Article and paragraph</i>		<i>Content</i>	<i>Deadline and comments</i>	
	(8) 1st and 2nd sentences	Arrangements and protection features	N.R.C., at the latest on renewal of the inland navigation vessel certificate after	1.1.2025
	(8) 3rd sentence	Symbol and warning device	N.R.C., at the latest on renewal of the inland navigation vessel certificate.	
	(8) 4 th sentence	Optical warning signal	N.R.C., at the latest on renewal of the inland navigation vessel certificate.	
	(9)	Emergency lowering system for lifting mechanisms which are not hydraulic	N.R.C., at the latest on renewal of the inland navigation vessel certificate after	1.1.2040
7.14	(3) 2 nd sentence	Enter and leave the wheelhouse, whatever its position	N.R.C., at the latest on renewal of the inland navigation vessel certificate.	
	(3) 3 rd sentence	Dimensions of the opening in the roof	N.R.C., at the latest on renewal of the inland navigation vessel certificate after	1.1.2035
	(4)	Stopping, locking and automatic deactivation	N.R.C.	
	(5)	No exceeding of terminal position	N.R.C., at the latest on renewal of the inland navigation vessel certificate.	
	(6) 1 st and 2 nd sentences	Arrangements and protection features	N.R.C.	
	(7)	Hydraulic hoses	N.R.C., at the latest on renewal of the inland navigation vessel certificate.	
CHAPTER 8				
8.02	(4)	Protection of connections of pipes	N.R.C., at the latest on renewal of the inland navigation vessel certificate after	1.1.2025
	(5)	Jacketed piping system	N.R.C., at the latest on renewal of the inland navigation vessel certificate after	1.1.2025
8.05	(3)	No fuel tanks aft of the aft-peak bulkhead	N.R.C., at the latest on renewal of the inland navigation vessel certificate after	1.1.2035

<i>Article and paragraph</i>		<i>Content</i>	<i>Deadline and comments</i>	
	(6), 3 rd to 5 th sentences	Installation and measurements of breather pipes and connection pipes	N.R.C., at the latest on renewal of the inland navigation vessel certificate after	1.1.2020
8.06		Tanks for lubricating oil, pipes and accessories	N.R.C., at the latest on renewal of the inland navigation vessel certificate after	1.1.2045
8.07		Tanks for oils in power transmission systems, control and activating systems and heating systems, pipes and accessories	N.R.C., at the latest on renewal of the inland navigation vessel certificate after	1.1.2045
8.10	(2)	Noise generated by a vessel under way	The vessels must satisfy the following conditions: the sound pressure level of the noise generated by a vessel under way does not exceed 75 dB(A) at a lateral distance of 25 m from the ship's side.	
	(3)	Noise generated by a vessel when stationary	The vessels must satisfy the following conditions: the sound pressure level of the noise generated by a vessel when stationary does not exceed 65 dB(A) at a lateral distance of 25 m from the ship's side.	

<i>Article and paragraph</i>		<i>Content</i>	<i>Deadline and comments</i>	
CHAPTER 9			Chapter 9 applies to engines with the following exceptions. a) Only Article 9.02 applies for engines which are already installed onboard and aa) non-type-approved or bb) for which no installation test had to be carried out. b) Without prejudice to (a), Article 9.10(2) only applies to repairs of engines carried out after 1 January 2024 including those carried out on an engine in service before this date. c) Without prejudice to (a), Article 9.01(2) does not apply for engines installed before 1 January 2020, if they comply with the provisions on type-approval and installation in force on the installation date.	
CHAPTER 10				
10.01	(1) second sentence	Required documents must be submitted to the inspection body	N.R.C., at the latest on renewal of the inland navigation vessel certificate after	1.1.2035
	(2)(e)	Switchboard plans as well as electric propulsion engine documentation	N.R.C., at the latest on renewal of the inland navigation vessel certificate after	1.1.2030
	(2)(f)	Plans for electronic systems	N.R.C., at the latest on renewal of the inland navigation vessel certificate after	1.1.2030
	(2)(g)	Control circuit plans	N.R.C., at the latest on renewal of the inland navigation vessel certificate after	1.1.2030
10.03		Type of protection according to installation location	N.R.C., at the latest on renewal of the inland navigation vessel certificate after	1.1.2030
10.04		Protection from explosion	N.R.C., at the latest on renewal of the inland navigation vessel certificate after	1.1.2022
10.06	(1) table	Three-phase alternating current	N.R.C., at the latest on renewal of the inland navigation vessel certificate after	1.1.2025

<i>Article and paragraph</i>		<i>Content</i>	<i>Deadline and comments</i>	
10.08	(1)	Compliance with European Standards EN 15869-1, EN 15869-3 and EN 16840	N.R.C., at the latest on renewal of the inland navigation vessel certificate after	1.1.2025
	(9)	Connection and disconnection when the line is dead	N.R.C., at the latest on renewal of the inland navigation vessel certificate after	1.1.2030
10.10	(2)	Installation of transformers	N.R.C., at the latest on renewal of the inland navigation vessel certificate after	1.1.2025
	(3)	Insulation of primary and secondary windings of transformers	N.R.C., at the latest on renewal of the inland navigation vessel certificate after	1.1.2050
	(4)	Tappings on the secondary windings of transformers	N.R.C., at the latest on renewal of the inland navigation vessel certificate after	1.1.2050
	(5)	Plate with manufacturer and power of engines, generators, transformers	N.R.C. except for engines, which come under Chapter 9 or Regulation (EU) 2016/1628 or Chapter 8a of the Rhine Vessel Inspection Regulations.	
10.11	(3)	Ventilation of service rooms and cupboard to the open deck	N.R.C., at the latest on renewal of the inland navigation vessel certificate.	
	(7)	Ventilation of enclosed rooms, cupboard or chest, in which accumulators are installed	N.R.C., at the latest on renewal of the inland navigation vessel certificate.	
	(12)	Measurement of charging devices	N.R.C., at the latest on renewal of the inland navigation vessel certificate after	1.1.2025
	(13)	Automatic chargers	N.R.C., at the latest on renewal of the inland navigation vessel certificate after	1.1.2025
	(14)	Maximum charging voltage	N.R.C., at the latest on renewal of the inland navigation vessel certificate after	1.1.2025
	(15)	European Standards EN 62619 and EN 62620 for lithium-ion accumulators	Lithium-ion accumulators installed before 7.10.2018 shall comply with the requirements of European Standards EN 62619 and EN 62620 at the latest on renewal of the inland navigation vessel certificate after	1.1.2028

<i>Article and paragraph</i>		<i>Content</i>	<i>Deadline and comments</i>	
	(16)	Accumulator management system	N.R.C., at the latest on renewal of the inland navigation vessel certificate after	1.1.2025
10.15	(11)	Cable harness penetrations	N.R.C., at the latest on renewal of the inland navigation vessel certificate after	1.1.2025
	(12)	Cables from an emergency electrical power source to consumer equipment	N.R.C., at the latest on renewal of the inland navigation vessel certificate after	1.1.2025
	(13)	Cable in areas with high ambient temperatures	N.R.C., at the latest on renewal of the inland navigation vessel certificate after	1.1.2025
	(14)	Installation of main and emergency power supply cables	N.R.C., at the latest on renewal of the inland navigation vessel certificate after	1.1.2025
10.18	(1)	Device for disconnecting from the mains	N.R.C., at the latest on renewal of the inland navigation vessel certificate after Legacy protection systems may remain in use if it is confirmed by an expert that they afford comparable protection.	1.1.2025
	(2)	Accessibility	N.R.C., at the latest on renewal of the inland navigation vessel certificate after	1.1.2050
	(3)	Galvanic separation of control and power circuits	N.R.C., at the latest on renewal of the inland navigation vessel certificate after	1.1.2025
	(4)	Operating with voltage and frequency variations	N.R.C., at the latest on renewal of the inland navigation vessel certificate after	1.1.2022
	(5)	Discharge time when disconnected from mains	N.R.C., at the latest on renewal of the inland navigation vessel certificate.	
	(6)	Response upon failure of external control signals	N.R.C., at the latest on renewal of the inland navigation vessel certificate after	1.1.2022
	(7)	Response upon failure of control voltages	N.R.C., at the latest on renewal of the inland navigation vessel certificate after	1.1.2022

<i>Article and paragraph</i>		<i>Content</i>	<i>Deadline and comments</i>	
	(8)	Error detection and prevention of undetected errors	N.R.C., at the latest on renewal of the inland navigation vessel certificate after	1.1.2022
	(9)	Monitoring	N.R.C., at the latest on renewal of the inland navigation vessel certificate after	1.1.2022
	(10)	Type examination	N.R.C.	
10.20		Test conditions for electronic installations	N.R.C., at the latest on renewal of the inland navigation vessel certificate after	1.1.2035
10.21		Electromagnetic compatibility	N.R.C., at the latest on renewal of the inland navigation vessel certificate after	1.1.2035
CHAPTER 11			N.R.C. However, electric propulsion systems installed between 1.1.2020 and 1.1.2026, shall comply at least with the Chapter 11 in ES-TRIN 2019/1.	
CHAPTER 13				
13.02	(2)(b)	Receptacles made of steel or another sturdy, non-flammable material and holding at least 10 litres	N.R.C., at the latest on renewal of the inland navigation vessel certificate.	
13.04		Permanently installed fire-fighting systems in accommodation spaces, wheelhouses and passenger rooms	N.R.C., at the latest on renewal of the inland navigation vessel certificate after	1.1.2035

<i>Article and paragraph</i>		<i>Content</i>	<i>Deadline and comments</i>	
13.05		Permanently installed fire-fighting systems in engine rooms, boiler rooms and pump rooms	<p>N.R.C.</p> <p>a) Permanent CO₂ fire-fighting systems installed before 1 October 1980 may remain in use until the renewal of the inland navigation certificate after 1.1.2035, if they comply with the requirements of Article 7.03(5) of the Rhine vessel inspection regulations in force on 1 April 1976 (Protocol CCNR 1975-I-23).</p> <p>b) Permanent CO₂ fire-fighting systems installed between 1 April 1992 and 31 December 1994 may remain in use until the renewal of the inland navigation certificate vessel after 1.1.2035, if they comply with the requirements of Article 7.03(5) of the Rhine vessel inspection regulations in force on 31 December 1994.</p> <p>c) Recommendations of the CCNR issued between 1 April 1992 and 31 December 1994 with regard to Article 7.03(5) of the Rhine vessel inspection regulations in force on 31 December 1994 remain valid until renewal of the inland navigation vessel certificate after 1.1.2035.</p> <p>d) Article 13.05(2)(a) is only applicable until the renewal of the inland navigation vessel certificate after 1.1.2035 if those installations have been installed in vessels laid down after 1 October 1992.</p>	
13.06		Permanently installed firefighting systems for protecting objects	N.R.C., at the latest on renewal of the inland navigation vessel certificate.	
13.07	(1)	Application of the European Standard to ship's boats	<p>N.R.C., at the latest on renewal of the inland navigation vessel certificate after</p> <p>For ship's boats which were on board before 1.10.2003, proof may be provided alternatively that they comply with the safety requirements of Article 32.06.</p>	

Article and paragraph		Content	Deadline and comments	
CHAPTER 14				
14.02	(4)	Equipping of the outer edges of decks, side decks and other work stations	N.R.C. ¹	
14.04	(1)	Clear width of side decks	For vessels of $B \leq 7,30 m$: N.R.C. ²	
			For vessels of $L < 55 m$ in length with stern accommodation only, N.R.C. ²	
			For all other vessels: N.R.C., at the latest on renewal of the inland navigation vessel certificate after	1.1.2035
14.05	(1)	Access to work stations	N.R.C., at the latest on renewal of the inland navigation vessel certificate after	1.1.2035
	(4)	Stairs in work stations which are manned continuously	N.R.C., at the latest on renewal of the inland navigation vessel certificate after	1.1.2035
14.06	(2)	Exits and emergency exits	N.R.C., at the latest on renewal of the inland navigation vessel certificate after	1.1.2035
14.07	(1) 2 nd sentence	Ladders, steps and similar devices	N.R.C., at the latest on renewal of the inland navigation vessel certificate after	1.1.2035

¹ However at the latest on renewal of the inland navigation vessel certificate after 1.1.2015, the craft must comply with the following requirements:

- The outer edges of the decks, as well as work stations where persons might fall more than 1 m, shall be fitted with bulwarks or coamings that are at least 0,70 m height or with continuous guard rails in accordance with European Standard EN 711 : 1995, comprising a handrail, intermediate rail at knee height and foot rail.
- Side decks shall be fitted with a foot rail and continuous handrail that is secured to the coaming. Coaming handrails shall not be required where side decks are fitted with non-retractable shipside guard rails.

² For vessels laid down after 31.12.1994 and for vessels in service, the requirement shall apply under the following conditions:

Should the entire hold area be replaced, the requirements of Article 14.04 must be complied with. In the event of modifications affecting the entire length of the side deck area and modifying the clear width of the side deck,

- a) Article 14.04 must be complied with when the clear width of the side deck to a height of 0,90 m, available before the modification, has to be reduced
- b) the clear width of the side deck to a height of 0,90 m or the clear width above that height, available before the modification, must not be reduced if their dimensions are less than those specified in Article 14.04.

<i>Article and paragraph</i>		<i>Content</i>	<i>Deadline and comments</i>	
14.12	(2)	Manufacturer's plate	N.R.C.	1.1.2020
	(4) first sentence	Safety devices	N.R.C. no later than after the first renewal of the inland navigation vessel certificate after	1.1.2020
	(4) second sentence	Safety clearance	N.R.C. at the latest on renewal of the inland navigation vessel certificate after	1.1.2020
			Should this provision not be achievable in practice after this date has expired, locations within workstations and passageways where the safety clearance is less than 0,50 m must be clearly marked as such.	
	(5)	Safety in operation	N.R.C. no later than after the first renewal of the inland navigation vessel certificate after	1.1.2020
(9)	Operating instructions	N.R.C. no later than after the first renewal of the inland navigation vessel certificate after	1.1.2020	
		If, after this date, operating instructions can no longer be obtained from the manufacturer, they will be written by a specialist. Thereafter, as of the first test in accordance with Article 14.12(6)(c), these operating instructions will be approved by the expert conducting this test.		
CHAPTER 15				
15.01	(1)	Accommodation for the persons lodging habitually on board	N.R.C., at the latest on renewal of the inland navigation vessel certificate after	1.1.2035
15.02	(3)	Situation of floors	N.R.C., at the latest on renewal of the inland navigation vessel certificate after	1.1.2035
	(4)	Communal living quarters and sleeping cabins	N.R.C., at the latest on renewal of the inland navigation vessel certificate after	1.1.2035
	(6)	Headroom in the accommodation	N.R.C., at the latest on renewal of the inland navigation vessel certificate after	1.1.2035

<i>Article and paragraph</i>		<i>Content</i>	<i>Deadline and comments</i>	
	(8)	Free floor area of communal living quarters	N.R.C., at the latest on renewal of the inland navigation vessel certificate after	1.1.2035
	(9)	Cubic capacity of rooms	N.R.C., at the latest on renewal of the inland navigation vessel certificate after	1.1.2035
	(10)	Volume of airspace per person	N.R.C., at the latest on renewal of the inland navigation vessel certificate after	1.1.2035
	(11)(a)	Size of doors	N.R.C., at the latest on renewal of the inland navigation vessel certificate after	1.1.2035
	(11)(c)	Doors which are located along escape routes	N.R.C., at the latest on renewal of the inland navigation vessel certificate after	1.1.2052
	(11)(d)	Doors which are locked from the inside	N.R.C., at the latest on renewal of the inland navigation vessel certificate after	1.1.2027
	(12)(a) and (b)	Situation of stairs	N.R.C., at the latest on renewal of the inland navigation vessel certificate after	1.1.2035
	(13)	Pipes carrying dangerous gases or liquids	N.R.C., at the latest on renewal of the inland navigation vessel certificate after	1.1.2035
15.03		Sanitary installations	N.R.C., at the latest on renewal of the inland navigation vessel certificate after	1.1.2035
15.04		Galleys	N.R.C., at the latest on renewal of the inland navigation vessel certificate after	1.1.2035
15.05	(1) 2 nd sentence	Filler neck of the potable water tanks	N.R.C., at the latest on renewal of the inland navigation vessel certificate.	
15.06		Heating and ventilation	N.R.C., at the latest on renewal of the inland navigation vessel certificate after	1.1.2035
15.07	(1) 2 nd sentence	Other accommodation installations	N.R.C., at the latest on renewal of the inland navigation vessel certificate after	1.1.2035

Article and paragraph		Content	Deadline and comments	
CHAPTER 18				
18.01	(2), Tables 1 and 2, and (7)	Limit/control values and type-approval	N.R.C., as long as	
			a) the limit and control values do not exceed the double values according to values of step II,	
			b) the on-board sewage treatment plant has a manufacturer's or expert's certificate confirming that it can cope with the typical loading patterns on board the craft.	
			On-board sewage treatment plants which have received an approval on or after 1 st December 2011, pursuant to requirements of the Resolution CCNR 2010-II-27 (Step II), may continue to be installed and used.	
			On-board sewage treatment plants which have received an approval on or after 10 January 2013, pursuant to requirements of the Directive 2012/49/EU (Step II), may continue to be installed and used.	
	(9)	Sampling point	N.R.C., at the latest on renewal of the inland navigation vessel certificate.	
18.11		Operation management manual	N.R.C., at the latest on renewal of the inland navigation vessel certificate.	
CHAPTER 19				
19.01	(2)(d)	Prohibition of solid fuel heaters according to Article 16.07	The provision does not apply to craft with solid fuel engines (steam engines).	
	(2)(e)	Prohibition of liquefied gas installations according to Chapter 17	N.R.C., at the latest on renewal of the inland navigation vessel certificate after	1.1.2045
			The transitional provision applies only if alarm systems are fitted in accordance with Article 19.15(8).	
(4) 2 nd and 3 rd sentences	Minimum number of seats and minimum number of cabins	N.R.C., at the latest on renewal of the inland navigation vessel certificate after	1.1.2064	

Article and paragraph		Content	Deadline and comments	
	(5) and (6)	Obstructed vision ahead of the vessel 2 vessel lengths if less than 250 m Sufficient view astern	N.R.C., at the latest on renewal of the inland navigation vessel certificate	1.1.2045
19.02	(1a)	Materials other than steel, such as aluminium alloy or Fibre Reinforced Plastic composites	N.R.C.	
	(2)	Number and position of bulkheads	N.R.C., at the latest on renewal of the inland navigation vessel certificate after	1.1.2045
	(3)	Situation of aft-peak bulkhead	N.R.C., at the latest on renewal of the inland navigation vessel certificate after	1.1.2035
			This requirement does not apply to passenger vessels that due to the compliance with the basic requirements for the two-compartment status set out in Article 19.03(9) or comply with the requirements of Article 19.07 achieve an equivalent level of safety and manoeuvrability.	
	(5) 2 nd sentence	Margin line if no bulkhead deck	For passenger vessels which have been laid down before 1.1.1996, N.R.C., at the latest on renewal of the inland navigation vessel certificate after	1.1.2045
	(10)(d)	Optical and acoustic signal	N.R.C., at the latest on renewal of the inland navigation vessel certificate.	
	(15)	Height of double bottoms, width of double sides	N.R.C., at the latest on renewal of the inland navigation vessel certificate after	1.1.2045
19.03	(1) to (6)	Intact stability	N.R.C., and when the maximum number of passengers is raised, at the latest on renewal of the inland navigation vessel certificate after	1.1.2045
	(1)(a)	Heeling test	N.R.C.: Heeling test not in accordance with Annex 1 of IMO Resolution MSC.267(85) are accepted.	
	(6) last sentence	passenger vessel capable of achieving greater speeds than $v = 0,4 \sqrt{gL}$	N.R.C., at the latest on renewal of the inland navigation vessel certificate after	1.1.2064

<i>Article and paragraph</i>		<i>Content</i>	<i>Deadline and comments</i>	
	(7) and (8)	Damage stability	N.R.C., at the latest on renewal of the inland navigation vessel certificate after	1.1.2045
	(9)	Damage stability	N.R.C., at the latest on renewal of the inland navigation vessel certificate after	1.1.2045
		Vertical extent of damage to the bottom of the boat	N.R.C., at the latest on renewal of the inland navigation vessel certificate after	1.1.2045
			N.R.C. applicable for vessels with watertight decks on a minimum distance of 0,50 m and less than 0,60 m of the bottom of vessels that obtained a first inland navigation vessel certificate before 31.12.2005	
	Two-compartment status	N.R.C.		
(10) to (13)	Damage stability	N.R.C., at the latest on renewal of the inland navigation vessel certificate after	1.1.2045	
19.05	(2)(a)	Number of passengers for whom the existence of an evacuation area according to Article 19.06(8) has been proven	N.R.C., at the latest on renewal of the inland navigation vessel certificate after	1.1.2045
	(2)(b)	Number of passengers that has been taken into account for the stability calculation according to Article 19.03	N.R.C., at the latest on renewal of the inland navigation vessel certificate after	1.1.2045
	(4)	Number of passengers displayed on the safety plan	N.R.C., at the latest on renewal of the inland navigation vessel certificate.	
19.06	(1) 1 st sentence	Passenger rooms on all decks aft of the collision bulkhead and, as long as they are below the bulkhead deck, forward of the aft peak bulkhead	N.R.C., at the latest on renewal of the inland navigation vessel certificate after	1.1.2045
	(3)(a)	Two exits which are as far apart from one another as possible	N.R.C., at the latest on renewal of the inland navigation vessel certificate after	1.1.2064
	(3)(c) 1 st sentence	Clear height of exits	N.R.C., at the latest on renewal of the inland navigation vessel certificate after	1.1.2045

<i>Article and paragraph</i>		<i>Content</i>	<i>Deadline and comments</i>	
	(3)(2) 2 nd sentence	Clear width of doors of passenger cabins and other small rooms	N.R.C., at the latest on renewal of the inland navigation vessel certificate after	1.1.2045
	(3) f) 1 st sentence	Size of emergency exits	N.R.C., at the latest on renewal of the inland navigation vessel certificate after	1.1.2045
	(3)(g)	Exits intended for use by persons with reduced mobility	N.R.C., at the latest on renewal of the inland navigation vessel certificate after	1.1.2045
	(4)(d)	Doors intended for use by persons with reduced mobility	N.R.C., at the latest on renewal of the inland navigation vessel certificate after	1.1.2045
	(5)	Requirements for connecting corridors	N.R.C., at the latest on renewal of the inland navigation vessel certificate after	1.1.2045
	(6)(b)	Escape routes to evacuation areas	N.R.C., at the latest on renewal of the inland navigation vessel certificate after	1.1.2045
	(6)(c)	No escape routes through galleys	N.R.C., at the latest on renewal of the inland navigation vessel certificate after Where an alternative escape route avoiding the galley cannot technically be implemented or its application imposes disproportionate costs, the inland navigation vessel certificate may be renewed only if: a) the risks associated with the escape route through the galley have been analysed, and b) the recommendations in accordance with this limited risk analysis have been implemented, to the satisfaction of the inspection body, in the galley. This limited risk analysis shall at least address the following: a) the accessibility of the escape route; b) fire hazards; c) risks from hot surfaces; d) slip and trip hazards on galley floors;	1.1.2020

<i>Article and paragraph</i>	<i>Content</i>	<i>Deadline and comments</i>	
		e) specific hazards for certain target groups such as persons with reduced mobility.	
(6)(d)	No rungs, ladders or the like installed along the escape routes	N.R.C., at the latest on renewal of the inland navigation vessel certificate after	1.1.2045
(8)	Requirements for muster areas	N.R.C., at the latest on renewal of the inland navigation vessel certificate after	1.1.2045
(9)	Requirements for stairs and their landings in the passenger areas	N.R.C., at the latest on renewal of the inland navigation vessel certificate after	1.1.2045
(10)(a) 1 st sentence	Railing according to European Standard	N.R.C., at the latest on renewal of the inland navigation vessel certificate after	1.1.2045
(10)(a) 2 nd sentence	Height of bulwarks and railings of decks intended for use by persons with reduced mobility	N.R.C., at the latest on renewal of the inland navigation vessel certificate after	1.1.2045
(11)	Parts of the vessel not considered as part of the escape routes	N.R.C., at the latest on renewal of the inland navigation vessel certificate after	1.1.2064
(12)(c) 1 st sentence	Clear width of openings used normally for the embarking or disembarking of persons with reduced mobility	N.R.C., at the latest on renewal of the inland navigation vessel certificate after	1.1.2045
(12)(c) 2 nd sentence	Equipment to enable persons to be transferred	N.R.C., at the latest on renewal of the inland navigation vessel certificate.	
(13)	Passageways and walls in passageways intended for use by persons with reduced mobility	N.R.C., at the latest on renewal of the inland navigation vessel certificate after	1.1.2045
(14) 1 st sentence	Design of glass doors and walls in passageways and window panes	N.R.C., at the latest on renewal of the inland navigation vessel certificate after	1.1.2045

<i>Article and paragraph</i>		<i>Content</i>	<i>Deadline and comments</i>	
	(15)	Requirements for superstructures that consist totally or partly of panoramic windows	N.R.C., at the latest on renewal of the inland navigation vessel certificate after	1.1.2045
	(17) 2 nd and 3 rd sentences	Requirements for toilets fitted for use by persons with reduced mobility	N.R.C., at the latest on renewal of the inland navigation vessel certificate after	1.1.2064
	(18)	Ventilation system for cabins without an opening window	N.R.C., at the latest on renewal of the inland navigation vessel certificate after	1.1.2045
	(19)	Requirements of Article 19.06 for rooms in which crew members or shipboard personnel are accommodated	N.R.C., at the latest on renewal of the inland navigation vessel certificate after	1.1.2045
19.07	(2)	Second independent propulsion system in a separate engine room	N.R.C., at the latest on renewal of the inland navigation vessel certificate after	1.1.2020
			<p>N.R.C. for passenger vessels that satisfy the following requirements:</p> <p>a) The existing firefighting system referred to in Article 19.12(9) to protect the engine room can be triggered immediately without danger to people located in the engine room. The transitional provision to article 13.05(2)(a) cannot be invoked</p> <p>If the existing firefighting system cannot be triggered immediately without danger to people located in the engine room as described above, the combustion engines in the engine room are protected with additional firefighting system for object protection, which can be triggered immediately without danger to people located in the engine room.</p>	

Article and paragraph		Content	Deadline and comments	
			<p>b) A firefighting system for object protection in accordance with Article 13.06, which can be triggered immediately without danger to people located in the engine room, is required for:</p> <ul style="list-style-type: none"> - the enclosed combustion engines; - the enclosed generators; - the main switchboard. <p>c) The firefighting systems for object protection referred to in (a) and (b) must be designed by a specialised firm. Furthermore, the requirements of Article 13.05(9) apply <i>mutatis mutandis</i>.</p> <p>d) In addition to the bilge systems referred to in Article 8.08, the engine room is equipped with an additional bilge pump.</p> <p>Its pumping capacity (Q) in l/min is calculated by $Q = d_2^2$. d_2 is to be calculated in accordance with section 8.08(3) and the maximum length of the engine room is to be used for “l”.</p> <p>The bilge pump must be located in the secure area.</p> <p>It must be possible to switch on the pump and operate the pressure valves from above the main deck.</p> <p>e) The total pump capacity of all pumps located in this engine room and capable of being used for pumping out must be at least 3000 l/min.</p> <p>f) (d) and (e) are not required if the main engines are located above the damage waterline in the event of flooding in the engine room.</p>	
19.08	(8) last sentence	Independent ventilation system	N.R.C., at the latest on renewal of the inland navigation vessel certificate after	1.1.2044

<i>Article and paragraph</i>		<i>Content</i>	<i>Deadline and comments</i>	
19.11	(1)	Suitability for fire protection of materials and components	N.R.C., at the latest on renewal of the inland navigation vessel certificate after For materials and components approved according to the International Code for the Application of Fire Test Procedures (FTP code) adopted under Resolution MSC.61(67) ¹ : N.R.C.	1.1.2045
	(2)	Design of partitions	N.R.C., at the latest on renewal of the inland navigation vessel certificate after	1.1.2045
	(4)	Lounge ceilings and wall claddings manufactured from non-combustible material	N.R.C., at the latest on renewal of the inland navigation vessel certificate after	1.1.2045
	(5)	Furniture and fittings in muster areas manufactured from non-combustible material	N.R.C., at the latest on renewal of the inland navigation vessel certificate after	1.1.2045
	(6)	Tested according to Code	N.R.C., at the latest on renewal of the inland navigation vessel certificate after	1.1.2045
	(7)	Insulation materials in lounges	N.R.C., at the latest on renewal of the inland navigation vessel certificate after	1.1.2045
	(9)	Requirements for doors in partitions	N.R.C., at the latest on renewal of the inland navigation vessel certificate after	1.1.2045
	(11)	Partitions	N.R.C., at the latest on renewal of the inland navigation vessel certificate after	1.1.2045
	(12)	Draught stops	N.R.C., at the latest on renewal of the inland navigation vessel certificate after	1.1.2045
	(13)	Stairs made of steel or another equivalent non-combustible material	N.R.C., at the latest on renewal of the inland navigation vessel certificate after	1.1.2045
	(14)	Internal stairs encapsulated at all levels by walls according to (2).	N.R.C., at the latest on renewal of the inland navigation vessel certificate after	1.1.2045

¹ MSC.61(67) adopted on 5 December 1996 - International Code for Application of Fire Test Procedures.

<i>Article and paragraph</i>		<i>Content</i>	<i>Deadline and comments</i>	
	(15)	Ventilation systems and air supply systems	N.R.C., at the latest on renewal of the inland navigation vessel certificate after	1.1.2045
	(16)	Ventilation systems in galleys and stoves with extractors	N.R.C., at the latest on renewal of the inland navigation vessel certificate after	1.1.2045
	(17)	Control centres, stairwells, muster areas and smoke extraction systems	N.R.C., at the latest on renewal of the inland navigation vessel certificate after	1.1.2045
19.12	(8)(d)	Installation of fire extinguishing pumps	Both pumps: N.R.C., at the latest on renewal of the inland navigation vessel certificate after	1.1.2035
19.13		Safety organisation	N.R.C., at the latest on renewal of the inland navigation vessel certificate.	
19.14	(1)	Equipment with waste water collection tanks or on-board sewage treatment plants	For cabin vessels with 50 sleeping berths or less and for day-trip vessels: N.R.C., at the latest on renewal of the inland navigation vessel certificate after	1.1.2030
	(2)	Requirements for waste water collection tanks	For cabin vessels with 50 sleeping berths or less and for day-trip vessels with 50 passengers or less: N.R.C., at the latest on renewal of the inland navigation vessel certificate after	1.1.2030
19.15	(1)	Damage stability	N.R.C., at the latest on renewal of the inland navigation vessel certificate after	1.1.2045
CHAPTER 21				
21.01	(2)	Special winches or equivalent coupling devices to be used for pushing purposes	For craft certified before 1.1.1995 for pushing without proper securing equipment: N.R.C., at the latest on renewal of the inland navigation vessel certificate after	1.1.2035
	(3) last sentence	Requirements for drive units	N.R.C., at the latest on renewal of the inland navigation vessel certificate after	1.1.2035

<i>Article and paragraph</i>		<i>Content</i>	<i>Deadline and comments</i>	
CHAPTER 22				
22.02	(3)	Additional requirements	The same transitional provisions as those indicated under the relevant article apply.	
CHAPTER 26				
26.01			For recreational craft built before 1.1.1995: N.R.C., at the latest on renewal of the inland navigation vessel certificate after	1.1.2035
CHAPTER 30				
30.02	(2)	Gaseous or particulate pollutants of engines with low flash point fuels	For engines complying with the type-approval and installation provisions in force at the date of installation: N.R.C.	

Article 32.03***Additional transitional provisions for craft which were laid down on or before 1 April 1976***

1. In addition to the transitional provisions of the Article 32.02, the following provisions may be applied to craft which were laid down on or before 1 April 1976.
2. The following definitions apply in the table below:

‘R.C.’: the provision does not apply to craft which are already operating, unless the parts concerned are replaced or converted, i.e. the provision applies only to the Replacement or Conversion of the parts or areas concerned. If existing parts are replaced by replacement parts using the same technology and of the same type, this does not constitute replacement ‘R’ within the meaning of the transitional provisions

‘Issue or renewal of the inland navigation vessel certificate’: the provision must be complied with the time of the next issue or renewal of the inland navigation vessel certificate after the date indicated.

<i>Article and paragraph</i>		<i>Content</i>	<i>Deadline and comments</i>	
CHAPTER 3				
3.04	(2)	Common surfaces of bunkers and accommodation and passenger rooms	R.C., at the latest on renewal of the inland navigation vessel certificate after	1.1.2035
CHAPTER 10				
10.01	(2)(a), (c) and (d)	<ul style="list-style-type: none"> - general plans, - indications of power requirements for electrical service equipment, - types of cables indicating conductor cross-sections 	R.C., at the latest on renewal of the inland navigation vessel certificate after	1.1.2020
			R.C. for vessels the plans of which are drawn up in accordance with Article 32.04(3) second sentence.	
CHAPTER 15				
15.02	(5)	Noise and vibration in accommodations	On renewal of the inland navigation vessel certificate after Where the prescribed limit value is not complied with after that date, the inland navigation vessel certificate may be renewed only if one of the two alternatives below is complied with.	1.1.2020

Article and paragraph		Content	Deadline and comments	
			<p>Alternative 1:</p> <p>a) The applicant can demonstrate to the satisfaction of the inspection body that he has done what reasonably can be expected of him to reduce the noise level in the accommodations in question;</p> <p>b) The remaining exceedance of the limit value does not exceed:</p> <ul style="list-style-type: none"> - 5 dB(A) in living quarters; - 10 dB(A) in sleeping quarters, and <p>c) Appropriate individual acoustic protection devices shall be available in rooms where the limit values are exceeded.</p> <p>If it is not possible to reduce the noise level throughout the sleeping quarters below the limit value as set out in (b), it is permissible to further reduce the ambient noise using local noise reduction measures, such as noise cancellation. This is subject to the provision that the ambient noise shall fall below the limit value as set out in (b). (c) shall apply <i>mutatis mutandis</i>.</p> <p>Alternative 2:</p> <p>The craft can continue its operating mode if monitoring by a tachograph ensures that the craft, at least for the rest periods prescribed by the Member States' domestic provisions; is operated at a main engine rpm at which the noise limit values in the sleeping quarters does not exceed 60 dB(A).</p> <p>This rpm value will be ascertained by trials upon first renewal of the inland navigation vessel certificate after 1.1.2020 and entered in the inland navigation vessel certificate.</p>	
CHAPTER 19				
19.02	(3)	Situation of collision and aft-peak bulkheads	R.C., at the latest on renewal of the inland navigation vessel certificate after	1.1.2045
	(5), (6) 1st sentence, (7) to (11), and (13)	Margin line if no bulkhead deck	R.C., at the latest on renewal of the inland navigation vessel certificate after	1.1.2045
	(16)	Watertight windows	R.C., at the latest on renewal of the inland navigation vessel certificate after	1.1.2045

<i>Article and paragraph</i>		<i>Content</i>	<i>Deadline and comments</i>	
19.04		Safety clearance, freeboard, immersion measures	R.C., at the latest on renewal of the inland navigation vessel certificate after	1.1.2045
19.05		Number of passengers	Renewal of the inland navigation vessel certificate after	1.1.2045
19.10	(4), (6), (7), (8) and (11)	Emergency power plant	R.C., at the latest on renewal of the inland navigation vessel certificate after	1.1.2045

3. Article 19.11(3) first sentence and (6) applies to day-trip vessels laid down on or before 1 April 1976 until the first renewal of the inland navigation vessel certificate after 1.1.2045, with the provision that only paints, varnishes, coatings and other materials used on surfaces facing escape routes and other materials for the surface treatment of panels must be fire-resistant and that smoke or toxic vapours may not develop to any dangerous extent.
4. Article 19.11(13) applies to day-trip vessels laid down on or before 1 April 1976 until the until the renewal of the inland navigation vessel certificate after 1.1.2045, with the provision that it is sufficient if, instead of stairs in the form of a load-bearing steel assembly, the stairs serving as an escape route are designed in such a way that they remain useable, in the event of a fire, for about the same time as stairs in the form of a load-bearing steel assembly.

Article 32.04
Other transitional provisions

1. The provisions of this article apply in addition to the transitional provisions of the Articles 32.02 and 32.03.
2. For craft the minimum freeboard of which was determined in accordance with Article 4.04 of the Rhine Vessel Inspection Regulations as applicable on 31 March 1983, the inspection body may, at the request of the owner, determine the freeboard in accordance with Article 4.03 of the Rhine Vessel Inspection Regulations as applicable on 1 January 1995.
3. The draught marks featuring on vessels already in operation shall comply with the requirements of Article 4.03 in terms of their characteristics and orientation at the latest on renewal of the inland navigation vessel certificate after 30 December 2024.
4. Craft laid down before 1 July 1983 do not need to conform to Chapter 10 of this Standard, but must at least conform to Chapter 6 of the Rhine Vessel Inspection Regulations as applicable on 31 March 1983.

By way of derogation from Article 6.01(2) of the Rhine Vessel Inspection Regulations as applicable on 31 March 1983, a limited general plan of the electrical installation containing the following minimum information shall suffice for craft which were laid down on or before 1 April 1976:

- energy sources;
 - connections to the shore or other external networks;
 - main and distribution switchboards;
 - protection devices of the main current;
 - switches;
 - cables cross-sections.
5. Article 19.06(3)(a) to (e), and Article 19.12(3)(a), with regard to the rule concerning a single hose length, apply only to passenger vessels laid down after 30 September 1984, and to conversions of the areas concerned, at the latest when the Rhine vessel inspection certificate is renewed after 1 January 2045.

6. Where this provision refers to a European or an International Standard, with regard to structural requirements:
 - a) pertaining to free-standing items of equipment, such items of equipment may, after any new publication or revision of the Standard, continue to be used for a further 20 years following the new publication or the revision of this Standard,
 - b) pertaining to permanently installed equipment parts, equipment parts may continue to be used until they are replaced or the areas in question have been converted.
7. High-speed vessels which had a valid Rhine vessel inspection certificate on 31 March 2003 shall meet provisions of Article 29.01(3), 29.02, 29.04, 29.05, 29.06(2), 29.10(2) and (3) on 1 January 2023.

Article 32.05
Transitional provisions for craft not covered by Article 32.01

1. The following provisions apply:
 - a) to craft for which a Rhine vessel inspection certificate in accordance with the Rhine Vessel Inspection Regulations was issued for the first time from 1 January 1995, provided they were not under construction or undergoing conversion on 31 December 1994,
 - b) to craft which have obtained another traffic licence between 1 January 1995 and 30 December 2008,
 - c) to craft for which a Community certificate valid for Zone R in accordance with Directive 2006/87/EC was issued for the first time between 30 December 2008 and 6 October 2018,
 - d) to craft for which a Union certificate valid for Zone R in accordance with Directive (UE) 2016/1629 was issued for the first time from 7 October 2018.
2. It must be proved that those craft comply:
 - a) with the Rhine Vessel Inspection Regulations, as applicable on the date on which their Rhine vessel inspection certificate or the other traffic licence has been granted, or
 - b) with the provisions of Directive 2006/87/EC applicable for Zone R, as applicable on the date on which their Community certificate has been granted, or
 - c) with the provisions of directive (UE) 2016/1629 applicable for Zone R, as applicable on the date on which their Union certificate has been granted.

3. Craft must be adapted to comply with this Standard in accordance with the transitional provisions set out in the table below.
4. Article 32.04(3), (5) and (6) apply *mutatis mutandis*.
5. The following definitions apply in the table below:

‘N.R.C.’: the provision does not apply to craft which are already operating, unless the parts concerned are replaced or converted, i.e. the provision applies only to Newly-built craft and to the Replacement or Conversion of the parts or areas concerned. If existing parts are replaced by replacement parts using the same technology and of the same type, this does not constitute replacement ‘R’ within the meaning of the transitional provisions.

‘Issue or renewal of the inland navigation vessel certificate’: the provision must be complied with the time of the next issue or renewal of the inland navigation vessel certificate after the date indicated.

Article and paragraph		Content	Deadline and comments		Date of entry into force
CHAPTER 3					
3.03	(1)(b)	Situation of aft-peak bulkhead	N.R.C., at the latest on renewal of the inland navigation vessel certificate after	1.1.2035	7.10.2018
	(2)	Accommodation aft of the aft-peak bulkhead	N.R.C., at the latest on renewal of the inland navigation vessel certificate after	1.1.2045	7.10.2018
		Safety equipment aft of the aft-peak bulkhead	N.R.C., at the latest on renewal of the inland navigation vessel certificate after	1.1.2035	7.10.2018
	(7)	Anchors not protruding in fore-sections of vessels	The provision comes into force from 1.1.2001: N.R.C., at the latest on renewal of the inland navigation vessel certificate after	1.1.2041	7.10.2018
CHAPTER 6					
6.02	(1)	Duplicated pilot valves in case of hydraulic drive units	N.R.C., at the latest on renewal of the inland navigation vessel certificate after	1.1.2020	1.4.2007

<i>Article and paragraph</i>		<i>Content</i>	<i>Deadline and comments</i>		<i>Date of entry into force</i>
		Separated pipework for the second drive unit in case of hydraulic drive units	N.R.C., at the latest on renewal of the inland navigation vessel certificate after	1.1.2020	1.4.2007
CHAPTER 7					
7.02	(6)	Safety glass design	N.R.C.		7.10.2018
7.05	(1)	Navigation lights, their casings, accessories and light sources	Navigation lights, their casings, accessories, and light sources that fulfill the requirements for colour and light intensity of lights on board, and for the admission of navigation lights for navigation on the Rhine, as of 30 November 2009 may still be used.		1.12.2009
7.06	(1)	Rate-of-turn indicators, which have received an approval before 1 st January 1990	Rate-of-turn indicators, which have received an approval before 1 st January 1990 and have been installed before 1st January 2000, may be maintained and used until renewal of the inland navigation vessel certificate after 1st January 2015, if there is a valid installation certificate pursuant to Directive 2006/87/EC ¹ or Resolution CCNR 1989-II-35.		1.12.2009
		Radar navigation installations and rate-of-turn indicators which have received an approval after 1 st January 1990	Radar navigation installations and rate-of-turn indicators which have received an approval on or after 1 st January 1990, pursuant to the minimum requirements and test conditions for radar installations used for navigation on the Rhine, as well as the minimum requirements and test conditions for rate-of-turn indicators used for navigation on the Rhine, may continue to be installed then be used if there is a valid installation certificate pursuant to this Standard, Directive 2006/87/EC or Resolution CCNR 1989-II-35.		1.12.2009

¹ Directive 2006/87/EC of the European Parliament and of the Council of 12 December 2006 laying down technical requirements for inland waterway vessels and repealing Council Directive 82/714/EEC (OJ L 389, 30.12.2006).

<i>Article and paragraph</i>		<i>Content</i>	<i>Deadline and comments</i>	<i>Date of entry into force</i>
		Radar navigation installations and rate-of-turn indicators which have received an approval after 31 st December 2006	Radar navigation installations and rate-of-turn indicators which have received an approval on or after 31 st December 2006, pursuant to the minimum requirements and test conditions of the Directive 2006/87/EC, may continue to be installed then be used if there is a valid installation certificate pursuant to this Standard or Directive 2006/87/EC.	7.10.2018
		Radar navigation installations and rate-of-turn indicators which have received an approval after 1 st December 2009	Radar navigation installations and rate-of-turn indicators which have received an approval on or after 1 st December 2009, pursuant to the minimum requirements and test conditions of the Resolution CCNR 2008-II-11 may continue to be installed then be used if there is a valid installation certificate pursuant to this Standard or Resolution CCNR 2008-II-11	7.10.2018
		Navigational radar installations which have received an approval based on European standard 302 194-1 : 2006.	Navigational radar installations which have received an approval based on European standard EN 302 194-1 : 2006 before 31 December 2023, may continue to be installed then be used if there is a valid installation certificate pursuant to this Standard.	1.1.2024
(2)	Inland ECDIS equipment being operated in navigation mode	Inland ECDIS equipment with a type-approval according to Edition 2.4 (or previous ones) of the Inland ECDIS Standard, ES-RIS 2021/1 or ES-RIS 2023/1, and installed before the 1st January 2026 may continue to be used.		1.1.2026
		Inland ECDIS equipment with a type-approval according to Edition 2.4 (or previous ones) of the Inland ECDIS Standard, ES-RIS 2021/1 or ES-RIS 2023/1, may continue to be installed then be used, when the current edition of the presentation library and the feature catalogue as required by ES-RIS (Parts I and V) has been implemented in the equipment.		1.1.2026

Article and paragraph		Content	Deadline and comments		Date of entry into force
		Inland ECDIS equipment being operated in navigation mode and which has received an approval based on European standard EN 302 194-1 : 2006	Inland ECDIS equipment which has received an approval based on European standard EN 302 194-1 : 2006 before 31 December 2023, may continue to be installed then be used if there is a valid installation certificate pursuant to this Standard.		1.1.2024
	(3)	Inland AIS equipment	Inland AIS equipment with a type-approval according to edition 1.0 and 1.01 of the Test Standard for Inland AIS and installed before the 1st December 2015 may continue to be used.		1.12.2013
			Inland AIS equipment with a type-approval according to edition 2.0 of the Test Standard for Inland AIS and installed before the 1st January 2024 may continue to be used.		1.1.2022
			Inland AIS equipment with a type-approval according to edition 2021/3.0 of ES-RIS 2021/1 or ES-RIS 2023/1 may continue to be installed then be used.		1.1.2026
7.12	(5) 2nd sentence	Indications	N.R.C., at the latest on renewal of the inland navigation vessel certificate.		7.10.2018
	(6)	Stopping, locking and automatic deactivation	N.R.C., at the latest on renewal of the inland navigation vessel certificate after	1.1.2025	7.10.2018
	(8) 1st and 2nd sentences	Arrangements and protection features	N.R.C., at the latest on renewal of the inland navigation vessel certificate after	1.1.2025	7.10.2018
	(8) 3rd sentence	Symbol and warning device	N.R.C., at the latest on renewal of the inland navigation vessel certificate.		1.1.2026
	(8) 4th sentence	Optical warning signal	N.R.C., at the latest on renewal of the inland navigation vessel certificate.		7.10.2018
	(9)	Emergency lowering system for lifting mechanisms which are not hydraulic	N.R.C., at the latest on renewal of the inland navigation vessel certificate after	1.1.2040	7.10.2018
7.14	(3) 2nd sentence	Enter and leave the wheelhouse, whatever its position	N.R.C., at the latest on renewal of the inland navigation vessel certificate.		1.1.2024

<i>Article and paragraph</i>		<i>Content</i>	<i>Deadline and comments</i>		<i>Date of entry into force</i>
	(3) 3 rd sentence	Dimensions of the opening in the roof	N.R.C., at the latest on renewal of the inland navigation vessel certificate after	1.1.2035	
	(4)	Stopping, locking and automatic deactivation	N.R.C.		
	(5)	No exceeding of terminal position	N.R.C., at the latest on renewal of the inland navigation vessel certificate.		
	(6) 1 st and 2 nd sentences	Arrangements and protection features	N.R.C.		
	(7)	Hydraulic hoses	N.R.C., at the latest on renewal of the inland navigation vessel certificate.		
CHAPTER 8					
8.02	(4)	Protection of connections of pipes	N.R.C., at the latest on renewal of the inland navigation vessel certificate after	1.1.2025	1.4.2007
	(5)	Jacketed piping system	N.R.C., at the latest on renewal of the inland navigation vessel certificate after	1.1.2025	1.4.2007
8.05	(3)	No fuel tanks aft of the aft-peak bulkhead	N.R.C., at the latest on renewal of the inland navigation vessel certificate after	1.1.2035	7.10.2018
8.06		Tanks for lubricating oil, pipes and accessories	N.R.C., at the latest on renewal of the inland navigation vessel certificate after	1.1.2045	1.4.2007
8.07		Tanks for oils in power transmission systems, control and activating systems and heating systems, pipes and accessories	N.R.C., at the latest on renewal of the inland navigation vessel certificate after	1.1.2045	1.4.2007

Article and paragraph		Content	Deadline and comments	Date of entry into force	
8.10	(2)	Noise generated by a vessel under way	The vessels must satisfy the following conditions: the sound pressure level of the noise generated by a vessel under way does not exceed 75 dB(A) at a lateral distance of 25 m from the ship's side.	1.1.2022	
	(3)	Noise generated by a vessel when stationary	The vessels must satisfy the following conditions: the sound pressure level of the noise generated by a vessel when stationary does not exceed 65 dB(A) at a lateral distance of 25 m from the ship's side.	1.1.2022	
CHAPTER 9			Chapter 9 applies to engines with the following exceptions. a) Only Article 9.02 applies for engines which are already installed onboard and aa) non-type-approved or bb) for which no installation test had to be carried out. b) Without prejudice to (a), Article 9.10(2) only applies to repairs of engines carried out after 1 January 2024 including those carried out on an engine in service before this date. c) Without prejudice to (a), Article 9.01(2) does not apply for engines installed before 1 January 2020, if they comply with the provisions on type-approval and installation in force on the installation date.	1.1.2024	
CHAPTER 10					
10.01	(1) second sentence	Required documents must be submitted to the inspection body	N.R.C., at the latest on renewal of the inland navigation vessel certificate after	1.1.2035	7.10.2018
	(2)(e)	Switchboard plans as well as electric propulsion engine documentation	N.R.C., at the latest on renewal of the inland navigation vessel certificate after	1.1.2030	7.10.2018
	(2)(f)	Plans for electronic systems	N.R.C., at the latest on renewal of the inland navigation vessel certificate after	1.1.2030	7.10.2018

<i>Article and paragraph</i>		<i>Content</i>	<i>Deadline and comments</i>		<i>Date of entry into force</i>
	(2)(g)	Control circuit plans	N.R.C., at the latest on renewal of the inland navigation vessel certificate after	1.1.2030	7.10.2018
10.03		Type of protection according to installation location	N.R.C., at the latest on renewal of the inland navigation vessel certificate after	1.1.2030	7.10.2018
10.04		Protection from explosion	N.R.C., at the latest on renewal of the inland navigation vessel certificate after	1.1.2022	7.10.2018
10.06	(1) table	Three-phase alternating current	N.R.C., at the latest on renewal of the inland navigation vessel certificate after	1.1.2025	7.10.2018
10.08	(1)	Compliance with European Standards EN 15869-1, EN 15869-3 and EN 16840	N.R.C., at the latest on renewal of the inland navigation vessel certificate after	1.1.2022	7.10.2018
	(9)	Connection and disconnection when the line is dead	N.R.C., at the latest on renewal of the inland navigation vessel certificate after	1.1.2025	7.10.2018
10.10	(2)	Installation of transformers	N.R.C., at the latest on renewal of the inland navigation vessel certificate after	1.1.2025	7.10.2018
	(3)	Separate primary and secondary windings of transformers	N.R.C., at the latest on renewal of the inland navigation vessel certificate after	1.1.2050	7.10.2018
	(4)	Tappings on the secondary windings of transformers	N.R.C., at the latest on renewal of the inland navigation vessel certificate after	1.1.2050	7.10.2018
	(5)	Plate with manufacturer and power of engines, generators, transformers	N.R.C. except for engines, which come under Chapter 9 or Regulation (EU) 2016/1628 or Chapter 8a of the Rhine Vessel Inspection Regulations.		7.10.2018
10.11	(3)	Ventilation of service rooms and cupboard to the open deck	N.R.C., at the latest on renewal of the inland navigation vessel certificate.		7.10.2018
	(12)	Measurement of charging devices	N.R.C., at the latest on renewal of the inland navigation vessel certificate after	1.1.2025	7.10.2018

<i>Article and paragraph</i>		<i>Content</i>	<i>Deadline and comments</i>		<i>Date of entry into force</i>
	(13)	Automatic chargers	N.R.C., at the latest on renewal of the inland navigation vessel certificate after	1.1.2025	7.10.2018
	(14)	Maximum charging voltage	N.R.C., at the latest on renewal of the inland navigation vessel certificate after	1.1.2025	7.10.2018
	(15)	European Standards EN 62619 and EN 62620 for lithium-ion accumulators	Lithium-ion accumulators installed before 7.10.2018 shall comply with the requirements of European Standards EN 62619 and EN 62620 at the latest on renewal of the inland navigation vessel certificate after	1.1.2028	7.10.2018
	(16)	Accumulator management system	N.R.C., at the latest on renewal of the inland navigation vessel certificate after	1.1.2025	7.10.2018
10.15	(11)	Cable harness penetrations	N.R.C., at the latest on renewal of the inland navigation vessel certificate after	1.1.2025	7.10.2018
	(12)	Cables from an emergency electrical power source to consumer equipment	N.R.C., at the latest on renewal of the inland navigation vessel certificate after	1.1.2025	7.10.2018
	(13)	Cable in areas with high ambient temperatures	N.R.C., at the latest on renewal of the inland navigation vessel certificate after	1.1.2025	7.10.2018
	(14)	Installation of main and emergency power supply cables	N.R.C., at the latest on renewal of the inland navigation vessel certificate after	1.1.2025	7.10.2018
10.18	(1)	Device for disconnecting from the mains	N.R.C., at the latest on renewal of the inland navigation vessel certificate after Legacy protection systems may remain in use if it is confirmed by an expert that they afford comparable protection.	1.1.2025	7.10.2018
	(2)	Accessibility	N.R.C., at the latest on renewal of the inland navigation vessel certificate after	1.1.2050	7.10.2018
	(3)	Galvanic separation of control and power circuits	N.R.C., at the latest on renewal of the inland navigation vessel certificate after	1.1.2025	7.10.2018

Article and paragraph		Content	Deadline and comments		Date of entry into force
	(4)	Operating with voltage and frequency variations	N.R.C., at the latest on renewal of the inland navigation vessel certificate after	1.1.2022	7.10.2018
	(5)	Discharge time when disconnected from mains	N.R.C., at the latest on renewal of the inland navigation vessel certificate.		7.10.2018
	(6)	Response upon failure of external control signals	N.R.C., at the latest on renewal of the inland navigation vessel certificate after	1.1.2022	7.10.2018
	(7)	Response upon failure of control voltages	N.R.C., at the latest on renewal of the inland navigation vessel certificate after	1.1.2022	7.10.2018
	(8)	Error detection and prevention of undetected errors	N.R.C., at the latest on renewal of the inland navigation vessel certificate after	1.1.2022	7.10.2018
	(9)	Monitoring	N.R.C., at the latest on renewal of the inland navigation vessel certificate after	1.1.2022	7.10.2018
	(10)	Type examination	N.R.C.		7.10.2018
10.20		Test conditions for electronic installations	N.R.C., at the latest on renewal of the inland navigation vessel certificate after	1.1.2035	7.10.2018
10.21		Electromagnetic compatibility	N.R.C., at the latest on renewal of the inland navigation vessel certificate after	1.1.2035	7.10.2018
CHAPTER 11			N.R.C. However, electric propulsion systems installed between 1.1.2020 and 1.1.2026, shall comply at least with the Chapter 11 in ES-TRIN 2019/1.		1.1.2026
CHAPTER 13					
13.04		Permanently installed fire-fighting systems in accommodation spaces, wheelhouses and passenger rooms	N.R.C., at the latest on renewal of the inland navigation vessel certificate after	1.1.2035	1.4.2002

<i>Article and paragraph</i>		<i>Content</i>	<i>Deadline and comments</i>		<i>Date of entry into force</i>
13.05		Permanently installed fire-fighting systems in engine rooms, boiler rooms and pump rooms	N.R.C., at the latest on renewal of the inland navigation vessel certificate a) Permanently installed CO ₂ fire-fighting systems installed between 1st January 1995 and 31st March 2003 shall continue to be accepted until renewal of the inland navigation vessel certificate after 1.1.2035 provided that they comply with Article 10.03(5) of the 31st March 2002 version of the Rhine vessel inspection regulations. b) The Central Commission for the Navigation of the Rhine's recommendations regarding Article 10.03(5) in the 31st March 2002 version of the Rhine vessel inspection regulations, issued between 1st January 1995 and 31st March 2002 shall remain valid until renewal of the inland navigation vessel certificate after 1.1.2035.		1.4.2002
13.06		Permanently installed firefighting systems for protecting objects	N.R.C., at the latest on renewal of the inland navigation vessel certificate.		
13.07	(1)	Application of the European Standard to ship's boats	N.R.C., at the latest on renewal of the inland navigation vessel certificate after For ship's boats which were on board before 1.10.2003, proof may be provided alternatively that they comply with the safety requirements of Article 32.06.	1.1.2020	1.10.2003
CHAPTER 14					
14.02	(4)	Equipping of the outer edges of decks, side decks and other work stations	N.R.C.		1.12.2011
14.12	(2), (4), (5) and (9)	Manufacturer's plate, protection devices, shipboard documents	N.R.C., at the latest on renewal of the inland navigation vessel certificate after	1.1.2020	1.12.2011

Article and paragraph		Content	Deadline and comments	Date of entry into force	
CHAPTER 15					
15.02	(11)(c)	Doors which are located along escape routes	N.R.C., at the latest on renewal of the inland navigation vessel certificate after	1.1.2052	1.1.2022
	(11)(d)	Doors which are locked from the inside	N.R.C., at the latest on renewal of the inland navigation vessel certificate after	1.1.2027	1.1.2022
15.05	(1), 2 nd sentence	Filler neck of the potable water tanks	N.R.C., at the latest on renewal of the inland navigation vessel certificate.		1.1.2026
CHAPTER 18					
18.01	(2), Tables 1 and 2, and (7)	Limit/control values and type-approval	N.R.C., as long as		1.12.2011
			a) the limit and control values do not exceed the double values according to values of step II,		
			b) the on-board sewage treatment plant has a manufacturer's or expert's certificate confirming that it can cope with the typical loading patterns on board the craft.		
		On-board sewage treatment plants which have received an approval on or after 1 st December 2011, pursuant to requirements of the Resolution CCNR 2010-II-27 (Step II), may continue to be installed and used.		7.10.2018	
		On-board sewage treatment plants which have received an approval on or after 10 January 2013, pursuant to requirements of the Directive 2012/49/EU (Step II), may continue to be installed and used.		7.10.2018	
	(9)	Sampling point	N.R.C., at the latest on renewal of the inland navigation vessel certificate.		1.1.2026
18.11		Operation management manual	N.R.C., at the latest on renewal of the inland navigation vessel certificate.		1.1.2026
CHAPTER 19					
19.01	(2)(e)	Prohibition of liquefied gas installations according to Chapter 17	N.R.C., at the latest on renewal of the inland navigation vessel certificate after	1.1.2045	1.1.2006
			The transitional provision applies only if alarm systems are fitted in accordance with Article 19.15(8).		1.1.2006

<i>Article and paragraph</i>		<i>Content</i>	<i>Deadline and comments</i>		<i>Date of entry into force</i>
	(4) 2 nd and 3 rd sentences	Minimum number of seats and minimum number of cabins	N.R.C., at the latest on renewal of the inland navigation vessel certificate after However, cabin vessel which have been laid down after 1.1.2006 must have a minimum of one cabin designed for persons with reduced mobility.	1.1.2064	1.1.2024
	(5) and (6)	Obstructed vision ahead of the vessel 2 vessel lengths if less than 250 m Sufficient view astern	N.R.C., at the latest on renewal of the inland navigation vessel certificate after	1.1.2045	7.10.2018
19.02	(1a)	Materials other than steel, such as aluminium alloy or Fibre Reinforced Plastic composites	N.R.C.		1.1.2024
	(2)	Number and position of bulkheads	N.R.C., at the latest on renewal of the inland navigation vessel certificate after	1.1.2045	1.1.2006
	(3)	Situation of aft-peak bulkhead	N.R.C., at the latest on renewal of the inland navigation vessel certificate after	1.1.2035	7.10.2018
			This requirement does not apply to passenger vessels that due to the compliance with the basic requirements for the two-compartment status set out in Article 19.03(9) or comply with the requirements of Article 19.07 achieve an equivalent level of safety and manoeuvrability.		7.10.2018
	(5) 2 th sentence	Margin line if no bulkhead deck	For passenger vessels which have been laid down before 1.1.1996, N.R.C., at the latest on renewal of the inland navigation vessel certificate after	1.1.2045	1.1.2006
	(10)(d)	Optical and acoustic signal	N.R.C., at the latest on renewal of the inland navigation vessel certificate.		1.1.2024
	(15)	Height of double bottoms, width of double sides	N.R.C., at the latest on renewal of the inland navigation vessel certificate after	1.1.2045	1.1.2006

Article and paragraph		Content	Deadline and comments		Date of entry into force
19.03	(1) to (6)	Intact stability	N.R.C., and when the maximum number of passengers is raised, at the latest on renewal of the inland navigation vessel certificate after	1.1.2045	1.1.2006
	(1)(a)	Heeling test	N.R.C.: Heeling test not in accordance with Annex 1 of IMO Resolution MSC.267(85) are accepted.		1.1.2024
	(6) last sentence	passenger vessel capable of achieving greater speeds than $v = 0,4 \sqrt{gL}$	N.R.C., at the latest on renewal of the inland navigation vessel certificate after	1.1.2064	1.1.2024
	(7) and (8)	Damage stability	N.R.C., at the latest on renewal of the inland navigation vessel certificate after	1.1.2045	1.1.2006
	(9)	Damage stability	N.R.C., at the latest on renewal of the inland navigation vessel certificate after	1.1.2045	1.1.2006
		Vertical extent of damage to the bottom of the boat	N.R.C., at the latest on renewal of the inland navigation vessel certificate after	1.1.2045	1.1.2006
			N.R.C. applicable for vessels with watertight decks on a minimum distance of 0,50m and less than 0,60 m of the bottom of vessels that obtained a first inland navigation vessel certificate before 31.12.2005.		1.12.2011
		Two-compartment status	N.R.C.		1.1.2006
(10) to (13)	Damage stability	N.R.C., at the latest on renewal of the inland navigation vessel certificate after	1.1.2045	1.1.2006	
19.05	(2)(a)	Number of passengers for whom the existence of an evacuation area according to Article 19.06(8) has been proven	N.R.C., at the latest on renewal of the inland navigation vessel certificate after	1.1.2045	1.1.2006
	(2)(b)	Number of passengers that has been taken into account for the stability calculation according to Article 19.03	N.R.C., at the latest on renewal of the inland navigation vessel certificate after	1.1.2045	1.1.2006

<i>Article and paragraph</i>		<i>Content</i>	<i>Deadline and comments</i>		<i>Date of entry into force</i>
	(4)	Number of passengers displayed on the safety plan	N.R.C., at the latest on renewal of the inland navigation vessel certificate.		1.1.2024
19.06	(1) 1 st sentence	Passenger rooms as long as they are below the bulkhead deck, forward of the aft-peak bulkhead	N.R.C., at the latest on renewal of the inland navigation vessel certificate after	1.1.2045	7.10.2018
	(1) 2 nd sentence	Enclosures	N.R.C., at the latest on renewal of the inland navigation vessel certificate.		1.12.2011
	(3)(a)	Two exits which are as far apart from one another as possible	N.R.C., at the latest on renewal of the inland navigation vessel certificate after	1.1.2064	1.1.2024
	(3)(c) 1 st sentence	Clear height of exits	N.R.C., at the latest on renewal of the inland navigation vessel certificate after	1.1.2045	1.1.2006
	(3)(c) 2 nd sentence	Clear width of doors of passenger cabins and other small rooms	N.R.C., at the latest on renewal of the inland navigation vessel certificate after	1.1.2045	1.1.2006
	(3)(f) 1 st sentence	Size of emergency exits	N.R.C., at the latest on renewal of the inland navigation vessel certificate after	1.1.2045	1.1.2006
	(3)(g)	Exits intended for use by persons with reduced mobility	N.R.C., at the latest on renewal of the inland navigation vessel certificate after	1.1.2045	1.1.2006
	(4)(d)	Doors intended for use by persons with reduced mobility	N.R.C., at the latest on renewal of the inland navigation vessel certificate after	1.1.2045	1.1.2006
	(5)	Requirements for connecting corridors	N.R.C., at the latest on renewal of the inland navigation vessel certificate after	1.1.2045	1.1.2006
	(6)(b)	Escape routes to evacuation areas	N.R.C., at the latest on renewal of the inland navigation vessel certificate after	1.1.2045	1.1.2006
(6)(c)	No escape routes through galleys	N.R.C., at the latest on renewal of the inland navigation vessel certificate after	1.1.2020	1.1.2020	

<i>Article and paragraph</i>	<i>Content</i>	<i>Deadline and comments</i>		<i>Date of entry into force</i>
		Where an alternative escape route avoiding the galley cannot technically be implemented or its application imposes disproportionate costs, the inland navigation vessel certificate may be renewed only if: <ul style="list-style-type: none"> a) the risks associated with the escape route through the galley have been analysed, and b) the recommendations in accordance with this limited risk analysis have been implemented, to the satisfaction of the inspection body, in the galley. This limited risk analysis shall at least address the following: <ul style="list-style-type: none"> a) the accessibility of the escape route; b) fire hazards; c) risks from hot surfaces; d) slip and trip hazards on galley floors; e) specific hazards for certain target groups such as persons with reduced mobility. 		
(6)(d)	No rungs, ladders or the like installed along the escape routes	N.R.C., at the latest on renewal of the inland navigation vessel certificate after	1.1.2045	1.1.2006
(8)	Requirements for muster areas	N.R.C., at the latest on renewal of the inland navigation vessel certificate after	1.1.2045	1.1.2006
		For vessels laid down after 1.1.2006, N.R.C., at the latest on renewal of the inland navigation vessel certificate.		1.1.2024
(9)(a), (b), (c), (e), and last sentence	Requirements for stairs and their landings in the passenger areas	N.R.C., at the latest on renewal of the inland navigation vessel certificate after	1.1.2045	1.1.2006
(9)(b)	Sum of the widths of all stairs	For vessels laid down after 1.1.2006, N.R.C., at the latest on renewal of the inland navigation vessel certificate after	1.1.2045	1.1.2024

<i>Article and paragraph</i>		<i>Content</i>	<i>Deadline and comments</i>		<i>Date of entry into force</i>
	(9)(c)	Handrails	For vessels laid down after 1.1.2006, N.R.C., at the latest on renewal of the inland navigation vessel certificate.		1.1.2024
	(9)(e)(aa)	Gradient of stairs	For vessels laid down after 1.1.2006, N.R.C., at the latest on renewal of the inland navigation vessel certificate after	1.1.2064	1.1.2024
	(9)(e)(cc)	Stairs straight and parallel to the longitudinal axis of the vessel	For vessels laid down after 1.1.2006, N.R.C., at the latest on renewal of the inland navigation vessel certificate.		1.1.2024
	(10)(a) 1 st sentence	Railing according to European Standard	N.R.C., at the latest on renewal of the inland navigation vessel certificate after	1.1.2045	1.1.2006
	(10)(a) 2 nd sentence	Height of bulwarks and railings of decks intended for use by persons with reduced mobility	N.R.C., at the latest on renewal of the inland navigation vessel certificate after	1.1.2045	1.1.2006
	(11)	Parts of the vessel not considered as part of the escape routes	N.R.C., at the latest on renewal of the inland navigation vessel certificate after	1.1.2064	1.1.2024
	(12)(c) 1 st sentence	Clear width of openings used normally for the embarking or disembarking of persons with reduced mobility	N.R.C., at the latest on renewal of the inland navigation vessel certificate after	1.1.2045	1.1.2006
	(12)(c) 2 nd sentence	Equipment to enable persons to be transferred	N.R.C., at the latest on renewal of the inland navigation vessel certificate.		1.1.2024
	(13)	Passageways and walls in passageways intended for use by persons with reduced mobility	N.R.C., at the latest on renewal of the inland navigation vessel certificate after	1.1.2045	1.1.2006
	(14) 1 st sentence	Design of glass doors and walls in passageways and window panes	N.R.C., at the latest on renewal of the inland navigation vessel certificate after	1.1.2045	1.1.2006

<i>Article and paragraph</i>		<i>Content</i>	<i>Deadline and comments</i>		<i>Date of entry into force</i>
	(15)	Requirements for superstructures that consist totally or partly of panoramic windows	N.R.C., at the latest on renewal of the inland navigation vessel certificate after	1.1.2045	1.1.2006
	(17) 2 nd and 3 rd sentences	Requirements for toilets fitted for use by persons with reduced mobility	N.R.C., at the latest on renewal of the inland navigation vessel certificate after	1.1.2064	1.1.2006
	(18)	Ventilation system for cabins without an opening window	N.R.C., at the latest on renewal of the inland navigation vessel certificate after	1.1.2045	1.1.2006
19.07	(2)	Second independent propulsion system in a separate engine room	N.R.C., at the latest on renewal of the inland navigation vessel certificate after	1.1.2020	1.1.2020
			<p>N.R.C. for passenger vessels that satisfy the following requirements :</p> <p>a) The existing firefighting system referred to in Article 19.12(9) to protect the engine room can be triggered immediately without danger to people located in the engine room. The transitional provision to article 13.05(2)(a) cannot be invoked.</p> <p>If the existing firefighting system cannot be triggered immediately without danger to people located in the engine room as described above, the combustion engines in the engine room are protected with additional firefighting system for object protection, which can be triggered immediately without danger to people located in the engine room.</p>		1.1.2020

Article and paragraph		Content	Deadline and comments	Date of entry into force	
			<p>b) A firefighting system for object protection in accordance with Article 13.06, which can be triggered immediately without danger to people located in the engine room, is required for:</p> <ul style="list-style-type: none"> - the enclosed combustion engines; - the enclosed generators; - the main switchboard. <p>c) The firefighting systems for object protection referred to in (a) and (b) must be designed by a specialised firm. Furthermore, the requirements of Article 13.05(9) apply <i>mutatis mutandis</i>.</p> <p>d) In addition to the bilge systems referred to in Article 8.08, the engine room is equipped with an additional bilge pump.</p> <p>Its pumping capacity (Q) in l/min is calculated by $Q = d_2^2$. d_2 is to be calculated in accordance with section 8.08(3) and the maximum length of the engine room is to be used for "l".</p> <p>The bilge pump must be located in the secure area.</p> <p>It must be possible to switch on the pump and operate the pressure valves from above the main deck.</p> <p>e) The total pump capacity of all pumps located in this engine room and capable of being used for pumping out must be at least 3000 l/min.</p> <p>f) (d) and (e) are not required if the main engines are located above the damage waterline in the event of flooding in the engine room.</p>		
19.08	(8) last sentence	Independent ventilation system	N.R.C., at the latest on renewal of the inland navigation vessel certificate after	1.1.2044	1.1.2024

<i>Article and paragraph</i>		<i>Content</i>	<i>Deadline and comments</i>		<i>Date of entry into force</i>
19.11	(1)	Suitability for fire protection of materials and components	N.R.C., at the latest on renewal of the inland navigation vessel certificate after	1.1.2045	1.1.2006
			For materials and components approved according to the International Code for the Application of Fire Test Procedures (FTP code) adopted under Resolution MSC.61(67) ¹ : N.R.C.		7.10.2018
	(2)	Design of partitions	N.R.C., at the latest on renewal of the inland navigation vessel certificate after	1.1.2045	1.1.2006
			For electrical service rooms of vessels laid down after 1.1.2006, N.R.C., at the latest on renewal of the inland navigation vessel certificate after	1.1.2044	1.1.2024
	(4)	Lounge ceilings and wall claddings manufactured from non-combustible material	N.R.C., at the latest on renewal of the inland navigation vessel certificate after	1.1.2045	1.1.2006
	(5)	Furniture and fittings in muster areas manufactured from non-combustible material	N.R.C., at the latest on renewal of the inland navigation vessel certificate after	1.1.2045	1.1.2006
	(6)	Tested according to Code	N.R.C., at the latest on renewal of the inland navigation vessel certificate after	1.1.2045	1.1.2006
	(7)	Insulation materials in lounges	N.R.C., at the latest on renewal of the inland navigation vessel certificate after	1.1.2045	1.1.2006
	(9)(a),(b), (c) 2 nd sentence and (d)	Requirements for doors in partitions	N.R.C., at the latest on renewal of the inland navigation vessel certificate after	1.1.2045	1.1.2006
	(11)	Partitions	N.R.C., at the latest on renewal of the inland navigation vessel certificate after	1.1.2045	1.1.2006

¹ MSC.61(67) adopted on 5 December 1996 - International Code for Application of Fire Test Procedures.

<i>Article and paragraph</i>		<i>Content</i>	<i>Deadline and comments</i>		<i>Date of entry into force</i>
	(13)	Stairs made of steel or another equivalent non-combustible material	N.R.C., at the latest on renewal of the inland navigation vessel certificate after	1.1.2045	1.1.2006
	(14)	Internal stairs encapsulated at all levels by walls according to (2).	N.R.C., at the latest on renewal of the inland navigation vessel certificate after	1.1.2045	1.1.2006
	(15)	Ventilation systems and air supply systems	N.R.C., at the latest on renewal of the inland navigation vessel certificate after	1.1.2045	1.1.2006
	(16)	Ventilation systems in galleys and stoves with extractors	N.R.C., at the latest on renewal of the inland navigation vessel certificate after	1.1.2045	1.1.2006
		Similar cooking appliances	For vessels laid down after 1.1.2006, N.R.C., at the latest on renewal of the inland navigation vessel certificate.		1.1.2024
	(17)	Control centres, stairwells, muster areas and smoke extraction systems	N.R.C., at the latest on renewal of the inland navigation vessel certificate after	1.1.2045	1.1.2006
19.13		Safety organisation	N.R.C., at the latest on renewal of the inland navigation vessel certificate.		1.1.2024
19.14	(1)	Equipment with waste water collection tanks or on-board sewage treatment plants	For cabin vessels with no more than 50 sleeping berths and for day-trip vessels: N.R.C., at the latest on renewal of the inland navigation vessel certificate after	1.1.2030	1.1.2006
	(2)	Requirements for waste water collection tanks	For cabin vessels with no more than 50 sleeping berths and for day-trip vessels with no more than 50 passengers: N.R.C., at the latest on renewal of the inland navigation vessel certificate after	1.1.2030	1.1.2006
19.15	(1)	Damage stability	N.R.C., at the latest on renewal of the inland navigation vessel certificate after	1.1.2045	1.1.2006

<i>Article and paragraph</i>		<i>Content</i>	<i>Deadline and comments</i>		<i>Date of entry into force</i>
CHAPTER 29					
29.02	(3)	Second independent steering apparatus drive unit or a manually operated drive unit come into operation	N.R.C., at the latest on renewal of the inland navigation vessel certificate after	1.1.2025	1.4.2005
CHAPTER 30					
30.02	(2)	Gaseous or particulate pollutants of engines with low flash point fuels	For engines complying with the type-approval and installation provisions in force at the date of installation: N.R.C.		1.1.2024

Article 32.06
Ship's boats which were on board craft before 1.10.2003

1. Ship's boats which were on board before 1.10.2003 shall be:
 - a) included in the list of ship's boats for the inland navigation published by the CESNI, or
 - b) compliant with the conditions specified in (2).

2. Ship's boats according to (1)(b) shall at least meet the following conditions:
- a) The ship's boat must be made of appropriate materials. Ship's boats made of a synthetic material must not exhibit any signs of deterioration.
 - b) The product of $L_B \cdot B_B \cdot H_B$ shall be at least $2,7\text{m}^3$.
 - c) The ship's boat must possess seating for the maximum permitted number of occupants and be able to manoeuvre safely with this number of occupants on board.
 - d) The freeboard of a ship's boat with the maximum permitted number of occupants on board must be equal to or greater than 25 cm.
 - e) The residual buoyancy in kN of the flooded unmanned craft must be at least $0,3 \cdot L_B \cdot B_B \cdot H_B$.
The ship's boat must have an upright floating position in all loading conditions.
 - f) The ship's boat must be fitted with appropriate equipment (two oars, a bailer, a mooring line, a rescue line, two thole pins, towing eye and lifting attachment).
 - g) The ship's boat shall be fitted with a drainage device made of corrosion-resistant material that can be quickly and securely closed at any time. The plug shall be permanently attached to the ship's boat.
 - h) All accessible parts of the ship's boat must be slip-resistant.
 - i) When the board cannot be grasped or if the freeboard of the empty ship's boat exceeds 30 cm, the ship's boat must be equipped with ropes or handholds so that someone in the water can hold on to it.
 - j) The ship's boat shall be provided on both sides with a retroreflective strip at least 0,1 m wide and 1 m long.
 - k) A signboard in the ship's boat must be affixed according to Annex 4, Figure 10.
 - l) For conditions (b) and (e):
 - L_B : Length of the ship's boat in m;
 - B_B : Breadth of the ship's boat in m;
 - H_B : Height of the ship's boat's sides in m.

Compliance of the ship's boat with these conditions shall be confirmed by an expert and the conditions c and e shall be verified by practical tests in standing water.

3. Ship's boats according to (1) must be marked by a metal plate according to the following pattern:

Ship's boat: UNIQUE EUROPEAN VESSEL IDENTIFICATION NUMBER: NUMBER OF RHINE VESSEL INSPECTION CERTIFICATE / UNION CERTIFICATE FOR INLAND NAVIGATION VESSELS: INSPECTION BODY:
--	---------------------------------

The indication on the metal plate must be confirmed by a vessel inspection body by the fact that its mark is stamped on the metal plate.

CHAPTER 33
TRANSITIONAL PROVISIONS FOR CRAFT OPERATING EXCLUSIVELY ON WATERWAYS OUTSIDE THE RHINE (ZONE R)

Article 33.01

Applicability of transitional provisions to craft which are already in service

1. The provisions of Article 33.02 to 33.03 apply to craft operating exclusively on waterways outside the Rhine (zone R):
 - a) for which a Community certificate was issued for the first time before 30 December 2008,
 - b) for which another traffic licence was issued before 30 December 2008.
2. It must be proved that those craft comply with the technical requirements of Chapters 1 to 12 of Annex II to Directive 82/714/EEC on the date on which the Community certificate or the other traffic licence is issued.
3. Community certificates issued before 30 December 2008 remain valid until the date of expiry indicated on the certificate.

Article 33.02

Transitional provisions for craft which are already in service

1. Craft that do not fully comply with the requirements of this Standard shall:
 - a) be adapted to comply with those provisions in accordance with the transitional provisions listed in the table below, and
 - b) until their adaptation, comply with the requirements of Chapters 1 to 12 of Annex II to Directive 82/714/EEC.

In the event of a new inland navigation vessel certificate being issued as defined in Article 33.01(1), the Community certificate or the other traffic licence shall be submitted as corroboration, the Community certificate or the other traffic licence shall be withdrawn and the date the Community certificate or the other traffic licence was issued shall be entered in item 52 of the new inland navigation vessel certificate as follows:

“A Community certificate according to Directive 82/714/EEC was issued ...”

/

“A traffic licence according to ... was issued on: ...”

2. The following definitions apply in the table below:

‘N.R.C.’: the provision does not apply to craft which are already operating, unless the parts concerned are replaced or converted, i.e. the provision applies only to Newly-built craft and to the Replacement or Conversion of the parts or areas concerned. If existing parts are replaced by replacement parts using the same technology and of the same type, this does not constitute replacement ‘R’ within the meaning of the transitional provisions.

‘Issue or renewal of the inland navigation vessel certificate’: the provision must be complied with the time of the next issue or renewal of the inland navigation vessel certificate after the date indicated.

<i>Article and paragraph</i>		<i>Content</i>	<i>Deadline and comments</i>	
CHAPTER 3				
3.03	(1)(a)	Situation of collision bulkhead	N.R.C., at the latest on renewal of the inland navigation vessel certificate after	30.12.2049
	(1)(b)	Situation of aft-peak bulkhead	N.R.C., at the latest on renewal of the inland navigation vessel certificate after	30.12.2049
	(2)	Accommodation forward of the collision bulkhead	N.R.C., at the latest on renewal of the inland navigation vessel certificate after	30.12.2024
		Accommodation aft of the aft-peak bulkhead	N.R.C., at the latest on renewal of the inland navigation vessel certificate after	30.12.2059
		Safety equipment forward of the collision bulkhead	N.R.C., at the latest on renewal of the inland navigation vessel certificate after	30.12.2029
		Safety equipment aft of the aft-peak bulkhead	N.R.C., at the latest on renewal of the inland navigation vessel certificate after	30.12.2049
	(4)	Gastight separation of accommodations from engine rooms, boiler rooms and holds	N.R.C., at the latest on renewal of the inland navigation vessel certificate after	30.12.2024
	(5), 2 nd subparagraph	Monitoring of doors in aft-peak bulkhead	N.R.C., at the latest on renewal of the inland navigation vessel certificate after	30.12.2024

<i>Article and paragraph</i>		<i>Content</i>	<i>Deadline and comments</i>	
	(7)	Anchors not protruding in fore-sections of vessels	N.R.C., at the latest on renewal of the inland navigation vessel certificate after	30.12.2049
3.04	(3) 2 nd sentence	Insulation in engine rooms	N.R.C., at the latest on renewal of the inland navigation vessel certificate.	
	(3) 3 rd and 4 th sentences	Openings and locking devices	N.R.C., at the latest on renewal of the inland navigation vessel certificate.	
	(6)	Exits of engine rooms	N.R.C., at the latest on renewal of the inland navigation vessel certificate after	30.12.2049
CHAPTER 4				
4.03		Draught marks	N.R.C., at the latest on renewal of the inland navigation vessel certificate after	30.12.2024
CHAPTER 5				
5.06	(1) 1 st sentence	Minimum speed	N.R.C., at the latest on renewal of the inland navigation vessel certificate after	30.12.2049
CHAPTER 6				
6.01	(1)	Manoeuvrability required by Chapter 5	N.R.C., at the latest on renewal of the inland navigation vessel certificate after	30.12.2049
	(3)	Permanent lists and ambient temperatures	N.R.C., at the latest on renewal of the inland navigation vessel certificate after	30.12.2024
	(7)	Design of rudder stocks	N.R.C., at the latest on renewal of the inland navigation vessel certificate after	30.12.2029
6.02	(1)	Presence of separate hydraulic tanks	N.R.C., at the latest on renewal of the inland navigation vessel certificate after	1.1.2026
		Duplicated pilot valves in case of hydraulic drive units	N.R.C., at the latest on renewal of the inland navigation vessel certificate after	1.1.2026

<i>Article and paragraph</i>		<i>Content</i>	<i>Deadline and comments</i>	
		Separated pipework for the second drive unit in case of hydraulic drive units	N.R.C., at the latest on renewal of the inland navigation vessel certificate after	1.1.2026
	(2)	Separated pipework for the second drive unit in case of hydraulic drive units	N.R.C., at the latest on renewal of the inland navigation vessel certificate after	1.1.2026
	(3)	Manoeuvrability required by Chapter 5 ensured by second drive unit or manual drive	N.R.C., at the latest on renewal of the inland navigation vessel certificate after	30.12.2049
6.03	(1)	Connection of other consumers to hydraulic steering apparatus drive unit	N.R.C., at the latest on renewal of the inland navigation vessel certificate after	1.1.2026
6.05	(1)	Wheel of manual drive not driven by powered drive unit	N.R.C., at the latest on renewal of the inland navigation vessel certificate after	30.12.2024
6.06	(1)	Two independent steering controls	N.R.C., at the latest on renewal of the inland navigation vessel certificate after	30.12.2029
6.08	(1)	Requirements for electrical equipment according to Article 10.20	N.R.C., at the latest on renewal of the inland navigation vessel certificate after	30.12.2029
CHAPTER 7				
7.02	(2) to (6)	Unobstructed view from the wheelhouse, except the following sections	N.R.C., at the latest on renewal of the inland navigation vessel certificate after	1.1.2049
	(3), 2 nd subparagraph	Unobstructed view in the sightline of the helmsman	N.R.C., at the latest on renewal of the inland navigation vessel certificate after	30.12.2029
	(6)	Minimal light transmission of glazing	N.R.C., at the latest on renewal of the inland navigation vessel certificate after	1.1.2024

Article and paragraph		Content	Deadline and comments	
			<p>N.R.C. for vessels with tinted windows satisfying the following conditions:</p> <ul style="list-style-type: none"> - The windows are tinted green and exhibit a minimum light transmission of 60 %, - The wheelhouse ceiling is so designed as to preclude reflections on the windows, - Light sources in the wheelhouse must be steplessly dimmable or capable of being switched off. - All reasonable measures to avoid other reflections have been taken. 	
		Safety glass design	N.R.C.	
7.03	(7)	Shutdown of alarms	N.R.C., at the latest on renewal of the inland navigation vessel certificate.	
	(8)	Automatic switch to another power source	N.R.C., at the latest on renewal of the inland navigation vessel certificate after	30.12.2024
7.04	(1)	Control of main engines and steering systems	N.R.C., at the latest on renewal of the inland navigation vessel certificate.	
	(2)	Control of each main engine	Unless steering positions have been designed for radar navigation by one person: N.R.C., at the latest on renewal of the inland navigation vessel certificate after	30.12.2049 if the direction of motion can be achieved directly 30.12.2024 for other engines.
	(9) 3th sentence	Control by a lever	N.R.C., at the latest on renewal of the inland navigation vessel certificate after	30.12.2024

<i>Article and paragraph</i>		<i>Content</i>	<i>Deadline and comments</i>	
	(9) 4 th sentence	Clearly show the direction of the thrust	N.R.C., at the latest on renewal of the inland navigation vessel certificate after	30.12.2024
	(10)(a), (b) and (c)	Monitoring of operational temperature, lubricating-oil pressure and oil and air pressure	N.R.C., at the latest on renewal of the inland navigation vessel certificate after	30.12.2024
	(10)(d), (e) and (f)	Rotational speed of the propulsion engines, rotational speed of the propulsors, direction of thrust imparted to the vessel by the propulsors	Unless steering positions have been designed for radar navigation by one person: N.R.C., at the latest on renewal of the inland navigation vessel certificate after	30.12.2024
	(11)(a), (b) and (c)	Alarm of operational temperature, lubricating-oil pressure and oil and air pressure	N.R.C., at the latest on renewal of the inland navigation vessel certificate after	30.12.2024
	(11)(e)	Filling level control not only for main engines but also other engines needed for safe operation of the vessel	N.R.C., at the latest on renewal of the inland navigation vessel certificate after	30.12.2029
	(11)(f)	Level alarm of the hydraulic tanks and alarm of the service pressure	N.R.C., at the latest on renewal of the inland navigation vessel certificate after	1.1.2026
7.05	(1)	Navigation lights, their casings, accessories and light sources	Navigation lights, their casings, accessories, and light sources that fulfill <ul style="list-style-type: none"> - the requirements for colour and light of lights on board, and the admission of navigation lights for navigation on the Rhine as of 30 November 2009 may still be used; - the respective requirements of a Member State as of 30 November 2009 may still be used. 	

<i>Article and paragraph</i>		<i>Content</i>	<i>Deadline and comments</i>	
7.06	(1)	Radar navigation installations and rate-of-turn indicators which have received an approval before 31 st December 2012	Radar navigation installations and rate-of-turn indicators, which have been approved and installed pursuant to a Member State's regulations before 31 st December 2012 may continue to be maintained and used until the renewal of the inland navigation vessel certificate after	31.12.2018
			These systems must be entered in item 52 of the inland navigation vessel certificate.	
		Radar navigation installations and rate-of-turn indicators which have received an approval after 1 st January 1990	Radar navigation installations and rate-of-turn indicators which have received an approval on or after 1 st January 1990, pursuant to the minimum requirements and test conditions for radar installations used for navigation on the Rhine and the minimum requirements and test conditions for rate-of-turn indicators used for navigation on the Rhine, may continue to be installed then be used if there is a valid installation certificate pursuant to this Standard, Directive 2006/87/EC or Resolution CCNR 1989-II-35.	
		Radar navigation installations and rate-of-turn indicators which have received an approval after 31 st December 2006	Radar navigation installations and rate-of-turn indicators which have received an approval on or after 31 st December 2006, pursuant to the minimum requirements and test conditions of the Directive 2006/87/EC, may continue to be installed then be used if there is a valid installation certificate pursuant to this Standard or Directive 2006/87/EC.	
		Radar navigation installations and rate-of-turn indicators which have received an approval after 1 st December 2009	Radar navigation installations and rate-of-turn indicators which have received an approval on or after 1 st December 2009, pursuant to the minimum requirements and test conditions of the Resolution CCNR 2008-II-11, may continue to be installed then be used if there is a valid installation certificate pursuant to this Standard or Resolution CCNR 2008-II-11.	
		Navigational radar installations which have received an approval based on European standard 302 194-1 : 2006.	Navigational radar installations which have received an approval based on European standard EN 302 194-1 : 2006 before 31 December 2023, may continue to be installed then be used if there is a valid installation certificate pursuant to this Standard.	

Article and paragraph		Content	Deadline and comments	
	(2)	Inland ECDIS equipment being operated in navigation mode	Inland ECDIS equipment with a type-approval according to Edition 2.4 (or previous ones) of the Inland ECDIS Standard, ES-RIS 2021/1 or ES-RIS 2023/1, and installed before the 1 st January 2026 may continue to be used.	
			Inland ECDIS equipment with a type-approval according to Edition 2.4 (or previous ones) of the Inland ECDIS Standard, ES-RIS 2021/1 or ES-RIS 2023/1, may continue to be installed then be used, when the current edition of the presentation library and the feature catalogue as required by ES-RIS (parts I and V) has been implemented in the equipment.	
		Inland ECDIS equipment being operated in navigation mode, and which has received an approval based on European standard EN 302 194-1 : 2006	Inland ECDIS equipment that has received an approval based on European standard EN 302 194-1 : 2006 before 31 December 2023, may continue to be installed then be used if there is a valid installation certificate pursuant to this Standard.	
	(3)	Inland AIS equipment	N.R.C.	
			Inland AIS equipment with a type-approval according to edition 2.0 of the Test Standard for Inland AIS and installed before the 1st January 2024 may continue to be used.	
			Inland AIS equipment with a type-approval according to edition 2021/3.0 of the Test Standard for Inland AIS, ES-RIS 2021/1 or ES-RIS 2023/1, may continue to be installed then be used	
7.09		Alarm system	N.R.C., at the latest on renewal of the inland navigation vessel certificate after	30.12.2024
7.12	(4) 3 rd sentence	Roof opening used as an emergency exit	N.R.C., at the latest on renewal of the inland navigation vessel certificate after	30.12.2049
	(5) 2 nd sentence	Indications	N.R.C., at the latest on renewal of the inland navigation vessel certificate.	
	(6)	Stopping, locking and automatic deactivation	N.R.C., at the latest on renewal of the inland navigation vessel certificate after	1.1.2025

<i>Article and paragraph</i>		<i>Content</i>	<i>Deadline and comments</i>	
	(8) 1st and 2nd sentences	Arrangements and protection features	N.R.C., at the latest on renewal of the inland navigation vessel certificate after	1.1.2025
	(8) 3 rd sentence	Symbol and warning device	N.R.C., at the latest on renewal of the inland navigation vessel certificate.	
	(8) 4 th sentence	Optical warning signal	N.R.C., at the latest on renewal of the inland navigation vessel certificate.	
	(9)	Emergency lowering system for lifting mechanisms which are not hydraulic	N.R.C., at the latest on renewal of the inland navigation vessel certificate after	1.1.2040
7.14	(3) 2 nd sentence	Enter and leave the wheelhouse, whatever its position	N.R.C., at the latest on renewal of the inland navigation vessel certificate.	
	(3) 3 rd sentence	Dimensions of the opening in the roof	N.R.C., at the latest on renewal of the inland navigation vessel certificate after	1.1.2035
	(4)	Stopping, locking and automatic deactivation	N.R.C.	
	(5)	No exceeding of terminal position	N.R.C., at the latest on renewal of the inland navigation vessel certificate.	
	(6) 1 st and 2 nd sentences	Arrangements and protection features	N.R.C.	
	(7)	Hydraulic hoses	N.R.C., at the latest on renewal of the inland navigation vessel certificate.	
CHAPTER 8				
8.01	(3)	Only internal-combustion engines burning fuels having a flashpoint of more than 55 °C	N.R.C., at the latest on renewal of the inland navigation vessel certificate after	30.12.2029

<i>Article and paragraph</i>		<i>Content</i>	<i>Deadline and comments</i>	
8.02	(1)	Securing of engines against unintentional starting	N.R.C., at the latest on renewal of the inland navigation vessel certificate after	30.12.2024
	(4)	Protection of connections of pipes	N.R.C., at the latest on renewal of the inland navigation vessel certificate after	30.12.2024
	(5)	Jacketed piping system	N.R.C., at the latest on renewal of the inland navigation vessel certificate after	30.12.2024
	(6)	Insulation of engine parts	N.R.C., at the latest on renewal of the inland navigation vessel certificate.	
8.03	(3)	Automatic protection against overspeed display and switch off	N.R.C., at the latest on renewal of the inland navigation vessel certificate after	30.12.2024
	(4)	Design of shaft bushings	N.R.C., at the latest on renewal of the inland navigation vessel certificate after	30.12.2029
8.05	(1)	Steel tanks for liquid fuels	N.R.C., at the latest on renewal of the inland navigation vessel certificate after	30.12.2029
	(2)	Automatic closing of tank valves	N.R.C., at the latest on renewal of the inland navigation vessel certificate.	
	(3)	No fuel tanks located forward of the collision bulkhead	N.R.C., at the latest on renewal of the inland navigation vessel certificate after	30.12.2024
		No fuel tanks aft of the aft-peak bulkhead	N.R.C., at the latest on renewal of the inland navigation vessel certificate after	30.12.2049
	(4)	No fuel tanks and their fittings above engines or exhaust pipes	N.R.C., at the latest on renewal of the inland navigation vessel certificate after	30.12.2024
			Until then, appropriate devices must ensure the safe evacuation of fuels.	
(6), 3 rd to 5 th sentences	Installation and measurements of breather pipes and connection pipes	N.R.C., at the latest on renewal of the inland navigation vessel certificate after	30.12.2024	

<i>Article and paragraph</i>		<i>Content</i>	<i>Deadline and comments</i>	
	(7), 1 st sentence	Quick-closing valve on the tank operated from deck, even when the rooms in question are closed	N.R.C., at the latest on renewal of the inland navigation vessel certificate after	1.1.2029
	(9), 2 nd sentence	Capacity-gauging devices to be legible up to maximum filling level	N.R.C., at the latest on renewal of the inland navigation vessel certificate after	30.12.2029
8.06		Tanks for lubricating oil, pipes and accessories	N.R.C., at the latest on renewal of the inland navigation vessel certificate after	30.12.2049
8.07		Tanks for oils in power transmission systems, control and activating systems and heating systems, pipes and accessories	N.R.C., at the latest on renewal of the inland navigation vessel certificate after	30.12.2049
8.08	(8)	Simple closing device not sufficient for connection of ballast spaces to drainage pipes for holds capable of carrying ballast	N.R.C., at the latest on renewal of the inland navigation vessel certificate after	30.12.2024
	(9)	Gauging devices in hold bilges	N.R.C., at the latest on renewal of the inland navigation vessel certificate after	30.12.2024
8.09	(2)	Installations for the collection of oily water and used oil stores	N.R.C., at the latest on renewal of the inland navigation vessel certificate after	30.12.2024
8.10	(2)	Noise generated by a vessel under way	The vessels must satisfy the following conditions: the sound pressure level of the noise generated by a vessel under way does not exceed 75 dB(A) at a lateral distance of 25 m from the ship's side.	
	(3)	Noise generated by a vessel when stationary	At the latest on renewal of the inland navigation vessel certificate after 30.12.2029, the vessels must satisfy the following conditions: the sound pressure level of the noise generated by a vessel when stationary does not exceed 65 dB(A) at a lateral distance of 25 m from the ship's side.	

Article and paragraph		Content	Deadline and comments	
CHAPTER 9			Chapter 9 applies to engines with the following exceptions. a) Only Article 9.02 applies for engines which are already installed onboard and aa) non-type-approved or bb) for which no installation test had to be carried out. b) Without prejudice to (a), Article 9.10(2) only applies to repairs of engines carried out after 1 January 2024 including those carried out on an engine in service before this date. c) Without prejudice to (a), Article 9.01(2) does not apply for engines installed before 1 January 2020, if they comply with the provisions on type-approval and installation in force on the installation date.	
CHAPTER 10				
10.01	(1) second sentence	Required documents must be submitted to the inspection body	N.R.C., at the latest on renewal of the inland navigation vessel certificate after	30.12.2049
	(2)(b)	Plans of main, emergency and distribution switchboards	N.R.C., at the latest on renewal of the inland navigation vessel certificate after	30.12.2024
	(2)(e)	Switchboard plans as well as electric propulsion engine documentation	N.R.C., at the latest on renewal of the inland navigation vessel certificate after	1.1.2030
	(2)(f)	Plans for electronic systems	N.R.C., at the latest on renewal of the inland navigation vessel certificate after	1.1.2030
	(2)(g)	Control circuit plans	N.R.C., at the latest on renewal of the inland navigation vessel certificate after	1.1.2030
	(3)	Ambient temperatures inside and on deck	N.R.C., at the latest on renewal of the inland navigation vessel certificate after	30.12.2024
10.02		Power supply systems	N.R.C., at the latest on renewal of the inland navigation vessel certificate after	30.12.2024

<i>Article and paragraph</i>		<i>Content</i>	<i>Deadline and comments</i>	
10.03		Type of protection according to installation location	N.R.C., at the latest on renewal of the inland navigation vessel certificate after	30.12.2029
10.04		Protection from explosion	N.R.C., at the latest on renewal of the inland navigation vessel certificate after	1.1.2022
10.05	(4)	Cross-section of earthing conductors	N.R.C., at the latest on renewal of the inland navigation vessel certificate after	30.12.2029
10.06	(1) table	Three-phase alternating current	N.R.C., at the latest on renewal of the inland navigation vessel certificate after	1.1.2025
10.08	(1)	Compliance with European Standards EN 15869-1, EN 15869-3 and EN 16840	N.R.C., at the latest on renewal of the inland navigation vessel certificate after	1.1.2025
	(9)	Connection and disconnection when the line is dead	N.R.C., at the latest on renewal of the inland navigation vessel certificate after	1.1.2030
10.10	(2)	Installation of transformers	N.R.C., at the latest on renewal of the inland navigation vessel certificate after	1.1.2025
	(3)	Insulation of primary and secondary windings of transformers	N.R.C., at the latest on renewal of the inland navigation vessel certificate after	1.1.2050
	(4)	Tappings on the secondary windings of transformers	N.R.C., at the latest on renewal of the inland navigation vessel certificate after	1.1.2050
	(5)	Plate with manufacturer and power of engines, generators, transformers	N.R.C. except for engines, which come under Chapter 9 or Regulation (EU) 2016/1628 or Chapter 8a of the Rhine Vessel Inspection Regulations.	
10.11	(3)	Ventilation of service rooms and cupboard to the open deck	N.R.C., at the latest on renewal of the inland navigation vessel certificate.	
	(7)	Ventilation of enclosed rooms, cupboard or chest, in which accumulators are installed	N.R.C., at the latest on renewal of the inland navigation vessel certificate.	

<i>Article and paragraph</i>		<i>Content</i>	<i>Deadline and comments</i>	
	(12)	Measurement of charging devices	N.R.C., at the latest on renewal of the inland navigation vessel certificate after	1.1.2025
	(13)	Automatic chargers	N.R.C., at the latest on renewal of the inland navigation vessel certificate after	1.1.2025
	(14)	Maximum charging voltage	N.R.C., at the latest on renewal of the inland navigation vessel certificate after	1.1.2025
	(15)	European Standards EN 62619 and EN 62620 for lithium-ion accumulators	Lithium-ion accumulators installed before 7.10.2018 shall comply with the requirements of European Standards EN 62619 and EN 62620 at the latest on renewal of the inland navigation vessel certificate after	1.1.2028
	(16)	Accumulator management system	N.R.C., at the latest on renewal of the inland navigation vessel certificate after	1.1.2025
10.12	(1), (2), (3)(a) and (4)	Switchgear and controlgear	N.R.C., at the latest on renewal of the inland navigation vessel certificate after	30.12.2029
	(3)(b)	Device for monitoring insulation equipped with an optical and acoustic alarm	N.R.C., at the latest on renewal of the inland navigation vessel certificate after	30.12.2024
10.13		Emergency circuit-breaker devices	N.R.C., at the latest on renewal of the inland navigation vessel certificate after	30.12.2029
10.14	(3), second sentence	Prohibition of single pole switches in laundries, washrooms and other rooms with wet facilities	N.R.C., at the latest on renewal of the inland navigation vessel certificate after	30.12.2024
10.15	(2)	Minimum cross-section per conductor of 1.5 mm ²	N.R.C., at the latest on renewal of the inland navigation vessel certificate after	30.12.2024
	(10)	Cables connected to elevating wheelhouses	N.R.C., at the latest on renewal of the inland navigation vessel certificate after	30.12.2024
	(11)	Cable harness penetrations	N.R.C., at the latest on renewal of the inland navigation vessel certificate after	1.1.2025

<i>Article and paragraph</i>		<i>Content</i>	<i>Deadline and comments</i>	
	(12)	Cables from an emergency electrical power source to consumer equipment	N.R.C., at the latest on renewal of the inland navigation vessel certificate after	1.1.2025
	(13)	Cable in areas with high ambient temperatures	N.R.C., at the latest on renewal of the inland navigation vessel certificate after	1.1.2025
	(14)	Installation of main and emergency power supply cables	N.R.C., at the latest on renewal of the inland navigation vessel certificate after	1.1.2025
10.16	(3) second sentence	Second circuit	N.R.C., at the latest on renewal of the inland navigation vessel certificate after	30.12.2029
10.18	(1)	Device for disconnecting from the mains	N.R.C., at the latest on renewal of the inland navigation vessel certificate after Legacy protection systems may remain in use if it is confirmed by an expert that they afford comparable protection.	1.1.2025
	(2)	Accessibility	N.R.C., at the latest on renewal of the inland navigation vessel certificate after	1.1.2050
	(3)	Galvanic separation of control and power circuits	N.R.C., at the latest on renewal of the inland navigation vessel certificate after	1.1.2025
	(4)	Operating with voltage and frequency variations	N.R.C., at the latest on renewal of the inland navigation vessel certificate after	1.1.2022
	(5)	Discharge time when disconnected from mains	N.R.C., at the latest on renewal of the inland navigation vessel certificate.	
	(6)	Response upon failure of external control signals	N.R.C., at the latest on renewal of the inland navigation vessel certificate after	1.1.2022
	(7)	Response upon failure of control voltages	N.R.C., at the latest on renewal of the inland navigation vessel certificate after	1.1.2022
	(8)	Error detection and prevention of undetected errors	N.R.C., at the latest on renewal of the inland navigation vessel certificate after	1.1.2022

<i>Article and paragraph</i>		<i>Content</i>	<i>Deadline and comments</i>	
	(9)	Monitoring	N.R.C., at the latest on renewal of the inland navigation vessel certificate after	1.1.2022
	(10)	Type examination	N.R.C.	
10.19		Alarm and safety systems for mechanical installations	N.R.C., at the latest on renewal of the inland navigation vessel certificate after	30.12.2029
10.20		Test conditions for electronic installations	N.R.C., at the latest on renewal of the inland navigation vessel certificate after	30.12.2049
10.21		Electromagnetic compatibility	N.R.C., at the latest on renewal of the inland navigation vessel certificate after	30.12.2049
CHAPTER 11			N.R.C. However, electric propulsion systems installed between 1.1.2020 and 1.1.2026, shall comply at least with the Chapter 11 in ES-TRIN 2019/1.	
CHAPTER 13				
13.01		Anchor equipment	N.R.C., at the latest on renewal of the inland navigation vessel certificate after	30.12.2024
13.02	(3)(a)	Certificate for mooring and other cables	First cable to be replaced on the vessel: N.R.C. at the latest after	30.12.2024
			Second and third cables to be replaced on the vessel: N.R.C. at the latest after	30.12.2029
13.03	(1)	European Standard	N.R.C., at the latest on renewal of the inland navigation vessel certificate after	30.12.2024
	(2)	Suitability for Class A, B and C fires	N.R.C., at the latest on renewal of the inland navigation vessel certificate after	30.12.2024
	(4)	Relation of CO ₂ content and size of room	N.R.C., at the latest on renewal of the inland navigation vessel certificate after	30.12.2024

<i>Article and paragraph</i>		<i>Content</i>	<i>Deadline and comments</i>	
13.04		Permanently installed fire-fighting systems in accommodation spaces, wheelhouses and passenger rooms	N.R.C., at the latest on renewal of the inland navigation vessel certificate after	30.12.2049
13.05		Permanently installed fire-fighting systems in engine rooms, boiler rooms and pump rooms	CO ₂ fire-fighting systems permanently installed before 1 January 1985, if they comply with the requirements of Article 13.03 of Directive 82/714/EEC as amended on 30.12.2006, may remain in use until the renewal of the inland navigation vessel certificate after	30.12.2049
13.06		Permanently installed firefighting systems for protecting objects	N.R.C., at the latest on renewal of the inland navigation vessel certificate.	
13.07	(1)	Application of the European Standard to ship's boats	N.R.C., at the latest on renewal of the inland navigation vessel certificate after For ship's boats which were on board before 1.1.2009, proof may be provided alternatively that they comply with the safety requirements of Article 33.04.	1.1.2029
13.08	(2)	Inflatable life jackets	N.R.C., at the latest on renewal of the inland navigation vessel certificate after	30.12.2024
			Life jackets which have been on board on 29.12.2008 may be used until the renewal of the inland navigation vessel certificate after	30.12.2024
CHAPTER 14				
14.02	(4)	Equipping of the outer edges of decks, side decks and other work stations	N.R.C. ¹	

¹ However at the latest on renewal of the inland navigation vessel certificate after 1.1.2015, the craft must comply with the following requirements:

- The outer edges of the decks, as well as work stations where persons might fall more than 1 m, shall be fitted with bulwarks or coamings that are at least 0,70 m height or with continuous guard rails in accordance with European Standard EN 711 : 1995, comprising a handrail, intermediate rail at knee height and foot rail.
- Side decks shall be fitted with a foot rail and continuous handrail that is secured to the coaming. Coaming handrails shall not be required where side decks are fitted with non-retractable shipside guard rails.

Article and paragraph		Content	Deadline and comments	
14.04	(1)	Clear width of side decks	For vessels of $B \leq 7,30 \text{ m}$: N.R.C. ¹	
			For vessels of $L < 55 \text{ m}$ in length with stern accommodation only, N.R.C. ¹	
			For all other vessels: N.R.C., at the latest on renewal of the inland navigation vessel certificate after	1.1.2035
14.05	(1)	Access to work stations	N.R.C., at the latest on renewal of the inland navigation vessel certificate after	30.12.2049
	(2) and (3)	Doors and accesses, exits and passageways where there is more than a 0,50 m difference in floor level	N.R.C., at the latest on renewal of the inland navigation vessel certificate.	
	(4)	Stairs in work stations which are manned continuously	N.R.C., at the latest on renewal of the inland navigation vessel certificate after	30.12.2049
14.06	(2)	Exits and emergency exits	N.R.C., at the latest on renewal of the inland navigation vessel certificate after	30.12.2049
14.07	(1) 2 nd sentence	Ladders, steps and similar devices	N.R.C., at the latest on renewal of the inland navigation vessel certificate after	30.12.2049
	(2) and (3)		N.R.C., at the latest on renewal of the inland navigation vessel certificate.	
14.10		Hatch covers	N.R.C., at the latest on renewal of the inland navigation vessel certificate after	30.12.2024
14.11		Winches	N.R.C., at the latest on renewal of the inland navigation vessel certificate after	30.12.2024

¹ For vessels laid down after 31.12.1994 and for vessels in service, the requirement shall apply under the following conditions:

Should the entire hold area be replaced, the requirements of Article 14.04 must be complied with. In the event of modifications affecting the entire length of the side deck area and modifying the clear width of the side deck,

- a) Article 14.04 must be complied with when the clear width of the side deck to a height of 0,90 m, available before the modification, has to be reduced
- b) the clear width of the side deck to a height of 0,90 m or the clear width above that height, available before the modification, must not be reduced if their dimensions are less than those specified in Article 14.04.

<i>Article and paragraph</i>		<i>Content</i>	<i>Deadline and comments</i>	
14.12	(2) to (6), (8) and (9)	Cranes: Manufacturer's plate, plaque du fabricant, maximum permissible loadings, protection devices, proof by calculation, expert inspection, shipboard documents	N.R.C., at the latest on renewal of the inland navigation vessel certificate after	30.12.2029
14.13		Storing of flammable liquids	N.R.C., at the latest on renewal of the inland navigation vessel certificate.	
CHAPTER 15				
15.01	(1)	Accommodation for the persons lodging habitually on board	N.R.C., at the latest on renewal of the inland navigation vessel certificate after	30.12.2049
15.02	(3)	Situation of floors	N.R.C., at the latest on renewal of the inland navigation vessel certificate after	30.12.2049
	(4)	Communal living quarters and sleeping cabins	N.R.C., at the latest on renewal of the inland navigation vessel certificate after	30.12.2049
	(5)	Noise and vibration in accommodations	N.R.C., at the latest on renewal of the inland navigation vessel certificate after	30.12.2029
	(6)	Headroom in accommodations	N.R.C., at the latest on renewal of the inland navigation vessel certificate after	30.12.2049
	(8)	Free floor area of communal living quarters	N.R.C., at the latest on renewal of the inland navigation vessel certificate after	30.12.2049
	(9)	Cubic capacity of rooms	N.R.C., at the latest on renewal of the inland navigation vessel certificate after	30.12.2049
	(10)	Volume of airspace per person	N.R.C., at the latest on renewal of the inland navigation vessel certificate after	30.12.2049
	(11)(a)	Size of doors	N.R.C., at the latest on renewal of the inland navigation vessel certificate after	30.12.2049
	(11)(c)	Doors which are located along escape routes	N.R.C., at the latest on renewal of the inland navigation vessel certificate after	1.1.2052

<i>Article and paragraph</i>		<i>Content</i>	<i>Deadline and comments</i>	
	(11)(d)	Doors which are locked from the inside	N.R.C., at the latest on renewal of the inland navigation vessel certificate after	1.1.2027
	(12)(a) and (b)	Situation of stairs	N.R.C., at the latest on renewal of the inland navigation vessel certificate after	30.12.2049
	(13)	Pipes carrying dangerous gases or liquids	N.R.C., at the latest on renewal of the inland navigation vessel certificate after	30.12.2049
15.03		Sanitary installations	N.R.C., at the latest on renewal of the inland navigation vessel certificate after	30.12.2049
15.04		Galleys	N.R.C., at the latest on renewal of the inland navigation vessel certificate after	30.12.2049
15.05	(1), 2 nd sentence	Filler neck of the potable water tanks	N.R.C., at the latest on renewal of the inland navigation vessel certificate.	
15.06		Heating and ventilation	N.R.C., at the latest on renewal of the inland navigation vessel certificate after	30.12.2049
15.07	(1), 2 nd sentence	Other accommodation installations	N.R.C., at the latest on renewal of the inland navigation vessel certificate after	30.12.2049
CHAPTER 18				
18.01	(2) Tables 1 and 2, and (7)	Limit/control values and type-approval	N.R.C., as long as	
			<ul style="list-style-type: none"> a) the limit and control values do not exceed the double values according to values of step II, b) the on-board sewage treatment plant has a manufacturer's or expert's certificate confirming that it can cope with the typical loading patterns on board the craft. 	
			On-board sewage treatment plants which have received an approval on or after 1 st December 2011, pursuant to requirements of the Resolution CCNR 2010-II-27 (Step II), may continue to be installed and used.	

<i>Article and paragraph</i>		<i>Content</i>	<i>Deadline and comments</i>	
			On-board sewage treatment plants which have received an approval on or after 10 January 2013, pursuant to requirements of the Directive 2012/49/EU (Step II), may continue to be installed and used.	
	(9)	Sampling point	N.R.C., at the latest on renewal of the inland navigation vessel certificate.	
18.11		Operation management manual	N.R.C., at the latest on renewal of the inland navigation vessel certificate.	
CHAPTER 19				
		Passengers vessels	See the provisions laid down in the regulations for vessels excluded from the scope of Directive 82/714/EEC: "Absence of manifest danger" Applies to all provisions of Chapter 19 except for those mentioned below.	
19.01	(5) and (6)	Obstructed vision ahead of the vessel 2 vessel lengths if less than 250 m Sufficient view astern	N.R.C., at the latest on renewal of the inland navigation vessel certificate	1.1.2049
19.02	(1a)	Materials other than steel, such as aluminium alloy or Fibre Reinforced Plastic composites	N.R.C.	
19.05	(4)	Number of passengers displayed on the safety plan	N.R.C., at the latest on renewal of the inland navigation vessel certificate.	
19.08	(10)	Automated external defibrillator	N.R.C., at the latest on renewal of the inland navigation vessel certificate.	
19.11	(1)	Suitability for fire protection of materials and components	For materials and components approved according to the International Code for the Application of Fire Test Procedures (FTP code) adopted under Resolution MSC.61(67) ¹ : N.R.C.	
19.13		Safety organisation	N.R.C., at the latest on renewal of the inland navigation vessel certificate.	

¹ MSC.61(67) adopted on 5 December 1996 - International Code for Application of Fire Test Procedures.

<i>Article and paragraph</i>		<i>Content</i>	<i>Deadline and comments</i>	
19.14	(1) and (2)	Equipment with waste water collection tanks or on-board sewage treatment plants Requirements for waste water collection tanks	N.R.C., at the latest on renewal of the inland navigation vessel certificate after	1.1.2030
CHAPTER 20				
		Passenger sailing vessels	See the provisions laid down in the regulations for vessels excluded from the scope of Directive 82/714/EEC: 'Absence of manifest danger'.	
CHAPTER 21				
21.01	(2)	Special winches or equivalent coupling devices to be used for pushing purposes	N.R.C., at the latest on renewal of the inland navigation vessel certificate after	30.12.2049
	(3) last sentence	Requirements for drive units	N.R.C., at the latest on renewal of the inland navigation vessel certificate after	30.12.2049
CHAPTER 22				
		Floating equipment	See the provisions laid down in the regulations for vessels excluded from the scope of Directive 82/714/EEC: 'Absence of manifest danger'.	
CHAPTER 26				
		Recreational craft	See the provisions laid down in the regulations for vessels excluded from the scope of Directive 82/714/EEC: 'Absence of manifest danger'.	

<i>Article and paragraph</i>		<i>Content</i>	<i>Deadline and comments</i>	
CHAPTER 29				
29.02	(3)	Second independent steering apparatus drive unit or a manually operated drive unit come into operation	N.R.C., at the latest on renewal of the inland navigation vessel certificate after	30.12.2029
CHAPTER 30				
30.02	(2)	Gaseous or particulate pollutants of engines with low flash point fuels	For engines complying with the type-approval and installation provisions in force at the date of installation: N.R.C.	

Article 33.03***Additional transitional provisions for craft which were laid down before 1 January 1985***

1. In addition to the transitional provisions of the Article 33.02, the following provisions may be applied to craft which were laid down before 1 January 1985 provided that there are appropriate guarantees for the safety of the craft and crew.
2. The following definitions apply in the table below:

‘N.R.C.’: the provision does not apply to craft which are already operating, unless the parts concerned are replaced or converted, i.e. the provision applies only to Newly-built craft and to the Replacement or Conversion of the parts or areas concerned. If existing parts are replaced by replacement parts using the same technology and of the same type, this does not constitute replacement (‘R’) within the meaning of the transitional provisions

‘Issue or renewal of the inland navigation vessel certificate’: the provision must be complied with the time of the next issue or renewal of the inland navigation vessel certificate after the date indicated.

<i>Article and paragraph</i>		<i>Content</i>	<i>Deadline and comments</i>	
CHAPTER 3				
3.03	(1)	Watertight collision bulkheads	N.R.C.	
	(2)	Accommodations, safety equipment	N.R.C.	
	(5)	Openings in watertight bulkheads	N.R.C.	
3.04	(2)	Common surfaces of bunkers and accommodation and passenger rooms	N.R.C.	
	(7)	Maximum permissible sound pressure level in engine room	N.R.C.	
CHAPTER 4				
4.01	(1)	Safety clearance	N.R.C., at the latest on renewal of the inland navigation vessel certificate after	30.12.2019
4.02		Freeboard	N.R.C.	

<i>Article and paragraph</i>		<i>Content</i>	<i>Deadline and comments</i>	
CHAPTER 6				
6.01	(3)	Requirements of steering system	N.R.C.	
CHAPTER 7				
7.01	(2)	Sound pressure generated by the vessel	N.R.C.	
7.12		Elevating wheelhouses	N.R.C.	
CHAPTER 8				
8.01	(3)	Prohibition of certain liquid fuels	N.R.C.	
8.05	(13)	Filling level control not only for main engines but also other engines needed for safe operation of the vessel	N.R.C.	
8.08	(2)	Equipment with bilge pumps	N.R.C.	
	(3) and (4)	Diameter and minimum pumping capacity of bilge pumps	N.R.C.	
	(5)	Self-priming bilge pumps	N.R.C.	
	(6)	Equipment with strainers	N.R.C.	
	(7)	Automatically closable fitting	N.R.C.	

<i>Article and paragraph</i>		<i>Content</i>	<i>Deadline and comments</i>	
8.10	(2)	Noise generated by a vessel under way	N.R.C. In case of replacement or conversion, the vessels must satisfy the following conditions: the sound pressure level of the noise generated by a vessel under way does not exceed 75 dB(A) at a lateral distance of 25 m from the ship's side.	
	(3)	Noise generated by a vessel when stationary	At the latest on renewal of the inland navigation vessel certificate after 30.12.2029, the vessels must satisfy the following conditions: the sound pressure level of the noise generated by a vessel when stationary does not exceed 65 dB(A) at a lateral distance of 25 m from the ship's side.	
CHAPTER 10				
10.01	(2)	Certificates for electrical equipment	N.R.C.	
	(3)	Design of electrical equipment	N.R.C.	
10.06		Maximum permissible voltages	N.R.C.	
10.10		Generators, engines and transformers	N.R.C.	
10.11	(3) and (5)	Installation of accumulators	N.R.C.	
10.12	(2)	Switches, protective devices	N.R.C.	
10.14	(3)	Simultaneous switching	N.R.C.	
10.15		Cables	N.R.C.	
10.16	(3)	Lighting in engine rooms	N.R.C.	
10.17		Navigation lights	N.R.C.	

<i>Article and paragraph</i>		<i>Content</i>	<i>Deadline and comments</i>	
CHAPTER 13				
13.01	(9)	Anchor windlasses for anchors having a mass in excess of 50 kg	N.R.C.	
13.07	(1)	Application of the European Standard to ship's boat	N.R.C.	
13.08	(1)	Application of the Standard to lifebuoys	N.R.C.	
	(2)	Application of the Standard to lifejackets	N.R.C.	
CHAPTER 14				
14.11	(2)	Safety of winches	N.R.C.	
CHAPTER 15				
15.02	(3)	Pipes carrying dangerous gases or liquids	N.R.C.	

Article 33.04
Ship's boats which were on board craft before 1.1.2009

1. Ship's boats which were on board before 1.1.2009 shall be:
 - a) included in the list of ship's boats for the inland navigation published by the CESNI, or
 - b) compliant with the conditions specified in Article 32.06(2).

2. Ship's boats according to (1) must be marked by a metal plate according to the following pattern:

Ship's boat: UNIQUE EUROPEAN VESSEL IDENTIFICATION NUMBER: NUMBER OF UNION CERTIFICATE FOR INLAND NAVIGATION VESSELS: INSPECTION BODY:
---	-------------------------

The indication on the metal plate must be confirmed by a vessel inspection body by the fact that its mark is stamped on the metal plate.

Article 33.05
Other transitional provisions

The provisions of Article 32.04(6) also apply to craft operating exclusively on waterways outside the Rhine.

EUROPEAN STANDARD ANNEXES

PART I

VESSEL IDENTIFICATION AND REGISTER

ANNEX 1

MODEL OF THE UNIQUE EUROPEAN VESSEL IDENTIFICATION NUMBER (ENI)

A	A	A	x	x	x	x	x
Code of the competent authority that assigns the unique European vessel identification number			Serial Number				

In the model, “AAA” represents the three digit code given by the competent authority assigning the unique European vessel identification number according to the following number ranges:

001 – 019	France
020 – 039	Netherlands
040 – 059	Germany
060 – 069	Belgium
070 – 079	Switzerland
080 – 099	reserved for craft from countries that are not party to the Mannheim Convention and for which a Rhine vessel inspection certificate has been issued before 1 April 2007.
100 – 119	Norway
120 – 139	Denmark
140 – 159	United Kingdom
160 – 169	Iceland
170 – 179	Ireland
180 – 189	Portugal
190 – 199	reserved
200 – 219	Luxembourg
220 – 239	Finland
240 – 259	Poland
260 – 269	Estonia
270 – 279	Lithuania
280 – 289	Latvia
290 – 299	reserved
300 – 309	Austria
310 – 319	Liechtenstein
320 – 329	Czech Republic
330 – 339	Slovakia
340 – 349	reserved
350 – 359	Croatia
360 – 369	Serbia
370 – 379	Bosnia and Herzegovina

380 – 399	Hungary
400 – 419	Russian Federation
420 – 439	Ukraine
440 – 449	Belarus
450 – 459	Republic of Moldova
460 – 469	Romania
470 – 479	Bulgaria
480 – 489	Georgia
490 – 499	reserved
500 – 519	Turkey
520 – 539	Greece
540 – 549	Cyprus
550 – 559	Albania
560 – 569	Republic of Northern Macedonia
570 – 579	Slovenia
580 – 589	Montenegro
590 – 599	reserved
600 – 619	Italia
620 – 639	Spain
640 – 649	Andorra
650 – 659	Malta
660 – 669	Monaco
670 – 679	San Marino
680 – 699	reserved
700 – 719	Sweden
720 – 739	Canada
740 – 759	United States of America
760 – 769	Israel
770 – 799	reserved
800 – 809	Azerbaijan
810 – 819	Kazakhstan
820 – 829	Kyrgyzstan
830 – 839	Tadjikistan
840 – 849	Turkmenistan
850 – 859	Uzbekistan
860 – 869	Iran
870 – 999	reserved

'xxxxx' represents the five-digit serial number given by the competent authority.

ANNEX 2

DATA FOR THE IDENTIFICATION OF A VESSEL

A. All vessels:

1. Unique European Vessel Identification Number (Annex 3, Section I, item 3 of the model, and Section VI, fifth column)
2. Name of the craft/vessel (Annex 3, Section I, item 1 of the model, and Section VI, fourth column)
3. Type of craft as defined in Article 1.01 (1.1) to (1.28) (Annex 3, Section I, item 2 of the model)
4. Length over all as defined in Article 1.01 (4.17) (Annex 3, Section I, item 17a)
5. Breadth over all as defined in Article 1.01 (4.20) (Annex 3, Section I, item 18a)
6. Draught as defined in Article 1.01 (4.23) (Annex 3, Section I, item 19a)
7. Source of data (= inland navigation vessel certificate)
8. Deadweight (Annex 3, Section I, item 21 and Section VI, 13th column) for cargo vessels
9. Displacement as defined in Article 1.01 (4.7) (Annex 3, Section I, item 21 and Section VI, 13th column) for vessels other than cargo vessels
10. Operator (owner or his representative)
11. Inspection body / Issuing Authority (Annex 3, Sections I and VI)
12. Number of inland navigation vessel certificate (Annex 3, Section I, and Section VI, first column)
13. Expiration date (Annex 3, Section I, item 11 of the model, and Section VI, 17th column)
14. Creator of dataset.

B. Where available:

1. National number
2. Type of craft in accordance with the Technical Specification for Electronic Ship Reporting in inland navigation
3. Single or double hull in accordance with ADN/ADNR
4. Height as defined in Article 1.01 (4.22)
5. Gross tonnage (for maritime vessels)
6. IMO number (for maritime vessels)
7. Call sign (for maritime vessels)
8. MMSI number
9. ATIS code
10. Type, number, issuing authority and expiration date of other certificates.

ANNEX 3
MODELS OF INLAND NAVIGATION VESSEL CERTIFICATES AND MODEL OF REGISTER OF INLAND NAVIGATION VESSEL CERTIFICATES

Section I
Model of inland navigation vessel certificate

Name of State / Seal

INLAND NAVIGATION VESSEL CERTIFICATE

No

Place, date

.....

Inspection body

.....

Stamp

.....

(Signature)

Remarks:

The craft may be used for navigation by virtue of this inland navigation vessel certificate only while in the condition herein described.

In the event of major alterations or repairs, the craft must undergo a special inspection before any new voyage.

The owner of a craft, or his representative, shall bring to the notice of the inspection body any change in the name or ownership of a craft, any re-measurement, and any change in the registration or home port, and shall send the inland navigation vessel certificate to that inspection body for amendment.

Inland navigation vessel certificate No of the inspection body

1. Name of craft	2. Type of craft	3. Unique European Vessel Identification Number
4. Name and address of owner		
5. Place of registration and registration number	6. Home port	
7. Year of construction	8. Name and location of shipyard	
9. This certificate replaces inland navigation vessel certificate No issued on by inspection body		
<p>10. The abovementioned craft,</p> <p style="margin-left: 40px;">subsequent to the inspection carried out on *)</p> <p style="margin-left: 40px;">on presentation of the certificate issued on *)</p> <p style="margin-left: 40px;">by the recognised classification society</p> <p style="margin-left: 40px;">is acknowledged as fit to operate:</p> <ul style="list-style-type: none"> - on the Rhine (*) between and *) - on EU waterways in Zone(s) (*) - on the waterways in Zone(s) (*) <p style="margin-left: 40px;">in [Name of States (*)]</p> <p style="margin-left: 40px;">except for:</p> <ul style="list-style-type: none"> - on the following waterways in [Name of the State (*)] <p style="margin-left: 40px;">at the maximum authorised draught and with the equipment and crew specified below.</p>		
11. The validity of this inland navigation vessel certificate expires on		
<p>*) Amendment to item(s):</p> <p style="margin-left: 40px;">New text:</p> <p>*) This page has been replaced.</p> <div style="display: flex; justify-content: space-between; align-items: flex-end; margin-top: 20px;"> <div style="text-align: center;"> <p>Place, date</p> <p>Stamp</p> <p>_____</p> <p>*) Delete as appropriate</p> </div> <div style="text-align: center;"> <p>Inspection body</p> <p>.....</p> <p>.....</p> <p>(Signature)</p> </div> </div>		

Inland navigation vessel certificate No of the inspection body

12. The inland navigation vessel certificate number (1), unique European vessel identification number (2), registration number (3) and measurement number (4) are affixed with the corresponding signs at the following locations on the craft

- 1
- 2
- 3
- 4

13. The maximum authorised draught is indicated on each side of the craft

- by two - – draught marks^{*)}.
- by the upper measurement plates^{*)}.

Two draught scales have been applied^{*)}.
The rear measurement scales serve as draught scales: they have been supplemented for that purpose by figures indicating the draughts^{*)}.

14. Without prejudice to the restrictions^{*)} mentioned in items 15 and 52, the craft is fit to

1.	push ^{*)}	4.	be propelled in a side-by-side formation ^{*)}
1.1	in rigid formation ^{*)}	5.	tow ^{*)}
1.2	with controlled articulation ^{*)}	5.1	craft having no motive power of their own ^{*)}
2.	be pushed ^{*)}	5.2	motorised craft ^{*)}
2.1	in rigid formation ^{*)}	5.3	upstream only ^{*)}
2.2	at the head of a rigid formation ^{*)}	6.	be towed ^{*)}
2.3	with controlled articulation ^{*)}	6.1	as a motorised craft ^{*)}
3.	propel a side-by-side formation ^{*)}	6.2	as a craft with no motive power of its own ^{*)}

^{*)} Amendment to item(s):
New text:

^{*)} This page has been replaced.
Place, date Inspection body

Stamp

.....
(Signature)

^{*)} Delete as appropriate

Inland navigation vessel certificate No of the inspection body

16. Measurement certificate No of the Measurement office dated			
17a. Length overall m	18a. Breadth overall m	19a. Draught overall m	20. Freeboard cm
17b. Length <i>L</i> m	18b. Breadth <i>B</i> m	19b. Draught <i>T</i> m	
21. Dead weight/Displacement *) t/m ³)		22. Number of passengers:	23. Number of sleeping berths:
24. Number of watertight transverse bulkheads		25. Number of holds	26. Type of hatch cover
27. Number of main propulsion engines		28. Total power rating of main means of propulsion kW	29. Number of main propellers
30. Number of bow windlasses of whichpowered		31. Number of stern windlasses of whichpowered	
32. Number of towing hooks		33. Number of towing winches of which	
34. Steering gear			
Number of rudder blades on main rudder	Main rudder drive	- manual *) - electric *)	- electric/hydraulic *) - hydraulic *)
Other installations: yes/no *) Type:			
Flanking rudder: yes/no *)	Flanking rudder drive:	- manual *) - electric *)	- electric/hydraulic *) - hydraulic *)
Bow rudder installation yes/no *)	- bow rudder *) - bow thruster *) - other installation *)	- Remote control yes/no *)	Remote activation yes/no *)
35. Bilge and drainage system			
Number of bilge pumps, of which power driven.....		
Minimum pumping capacity	first bilge pump	l/min	
	second bilge pump	l/min	
*) Amendment to item(s):			
New text:			
.....			
.....			
*) This page has been replaced.			
Place, date		Inspection body	
Stamp		
		
		(Signature)	
*) Delete as appropriate			

Inland navigation vessel certificate No of the inspection body

36. Number and position of closures referred to in Article 8.08, sections 10 and 11

37. Anchors			
Number of bow anchors	Total mass of bow anchors kg	Number of stern anchors	Total mass of stern anchors kg

38. Anchors chains		
Number of bow anchor chains	Length of each chain m	Breaking load of each chain kN
Number of stern anchor chains	Length of each chain m	Breaking load of each chain kN

39. Mooring cables

1st cable m long with a breaking load of kN

2nd cable m long with a breaking load of kN

3rd cable m long with a breaking load of kN

40. Towing cables

..... with a length of m and a breaking load of kN

..... with a length of m and a breaking load of kN

41. Visual and audible signals

The lights, flags, balls, floats and audible warning devices used for signalling and to emit the visual and audible signals prescribed by [the Rhine police regulations / the applicable navigational authority regulations of the Member States] are carried on board, as are the stand-alone emergency mooring lights prescribed by [the Rhine police regulations / the applicable navigational authority regulations of the Member States].

*) Amendment to item(s):

New text:

.....

.....

*) This page has been replaced.

Place, date Inspection body

Stamp (Signature)

*) Delete as appropriate

Inland navigation vessel certificate No of the inspection body

46. Operating modes meeting [A1¹⁾, A2²⁾, B¹⁾. / the requirements of national or international law concerning the crew]

47. Vessel equipment in accordance with Article 31.01.
The vessel complies ^{*)} / does not comply ^{*)} with Article 31.02 (Standard S1^{*)} / Article 31.03 (Standard S2^{*)}.
[In accordance with Article 19.05 of the Regulations for Rhine navigation personnel / In accordance with national or international requirements], the minimum crew needs to be increased as follows^{*)} / does not need to be increased:^{*)}:

	Operating modes ¹		

Observations and special conditions:

.....
.....
.....

48. Minimum crew [according to Article 19.06 of the Regulations for Rhine navigation personnel / in accordance with national or international requirements]

	Operating modes ²		

Observations and special conditions:

.....
.....
.....
.....

^{*)} Amendment to item(s):
New text:

^{*)} This page has been replaced.
Place, date Inspection body
Stamp
(Signature)

^{*)} Delete as appropriate

¹ The Rhine inspection certificate will refer to: boatman, boatman replaced by an able boatman; operating modes A1, A2 and B.
² The Rhine inspection certificate will refer to: Boatmaster, helmsman, able boatman, boatman, apprentice, engineer: operating modes A1, A2 and B.

Inland navigation vessel certificate No of the inspection body

49. Extension/confirmation *) of inland navigation vessel certificate validity*) periodical - special*) inspection

The inspection body inspected the vessel on *).

A certificate dated from the recognised classification society
.....
was presented to the inspection body*).

Reason for the inspection/certificate*):
.....
.....

In view of – the inspection result - certificate - *), the period of validity of the inland navigation vessel certificate is maintained – extended -*)
until
.....,

(Place) (date)

Stamp Inspection body
.....
(Signature)

*) Delete as appropriate

49. Extension/confirmation *) of inland navigation vessel certificate validity*) periodical - special*) inspection

The inspection body inspected the vessel on *).

A certificate dated from the recognised classification society
.....
was presented to the inspection body*).

Reason for the inspection/certificate*):
.....
.....

In view of – the inspection result - certificate - *), the period of validity of the inland navigation vessel certificate is maintained – extended -*)
until
.....,

(Place) (date)

Stamp Inspection body
.....
(Signature)

*) Delete as appropriate

49. Extension/confirmation *) of inland navigation vessel certificate validity*) periodical - special*) inspection

The inspection body inspected the vessel on *).

A certificate dated from the recognised classification society
.....
was presented to the inspection body*).

Reason for the inspection/certificate*):
.....
.....

In view of – the inspection result - certificate - *), the period of validity of the inland navigation vessel certificate is maintained – extended -*)
until
.....,

(Place) (date)

Stamp Inspection body
.....
(Signature)

*) Delete as appropriate

Inland navigation vessel certificate No of the inspection body

49. Extension/confirmation *) of inland navigation vessel certificate validity*) periodical - special*) inspection

The inspection body inspected the vessel on *).

A certificate dated from the recognised classification society
.....
.....
was presented to the inspection body*).

Reason for the inspection/certificate*):
.....
.....

In view of – the inspection result - certificate - *), the period of validity of the inland navigation vessel certificate is maintained – extended -*)
until
....., le
(Place) (date)

Stamp Inspection body
.....
(Signature)

*) Delete as appropriate

49. Extension/confirmation *) of inland navigation vessel certificate validity*) periodical - special*) inspection

The inspection body inspected the vessel on *).

A certificate dated from the recognised classification society
.....
.....
was presented to the inspection body*).

Reason for the inspection/certificate*):
.....
.....

In view of – the inspection result - certificate - *), the period of validity of the inland navigation vessel certificate is maintained – extended -*)
until
.....,
(Place) (date)

Stamp Inspection body
.....
(Signature)

*) Delete as appropriate

49. Extension/confirmation *) of inland navigation vessel certificate validity*) periodical - special*) inspection

The inspection body inspected the vessel on *).

A certificate dated from the recognised classification society
.....
.....
was presented to the inspection body*).

Reason for the inspection/certificate*):
.....
.....

In view of – the inspection result - certificate - *), the period of validity of the inland navigation vessel certificate is maintained – extended -*)
until
.....,
(Place) (date)

Stamp Inspection body
.....
(Signature)

*) Delete as appropriate

Inland navigation vessel certificate No of the inspection body

51. Extension of the attestation relating to liquefied gas installation(s)
The period covered by the attestation relating to liquefied gas installation(s)
dated valid until.....
is extended
- following the periodical inspection by the expert.....
- on presentation of the inspection attestation dated

until

.....,

(Place) (Date)

Stamp Inspection body

(Signature)

51. Extension of the attestation relating to liquefied gas installation(s)
The period covered by the attestation relating to liquefied gas installation(s)
dated valid until.....
is extended
- following the periodical inspection by the expert.....
- on presentation of the inspection attestation dated

until

.....,

(Place) (Date)

Stamp Inspection body

(Signature)

51. Extension of the attestation relating to liquefied gas installation(s)
The period covered by the attestation relating to liquefied gas installation(s)
dated valid until.....
is extended
- following the periodical inspection by the expert.....
- on presentation of the inspection attestation dated

until

.....,

(Place) (Date)

Stamp Inspection body

(Signature)

Section II
Model of provisional inland navigation vessel certificate

Name of State / Seal

Provisional inland navigation vessel certificate

n°

1. Name of craft	2. Type of craft	3. Unique European vessel identification number																
4. Name and address of owner																		
5. Length <i>L</i> / <i>L_{WL}</i> ¹⁾ Number of passengers Number of sleeping berths ¹⁾																		
6. Crew:																		
6.1 [The vessel is accepted for operating mode A1 ¹⁾ , A2 ¹⁾ , B ¹⁾ / Heading referring to the operating modes in accordance with national and international requirements.]																		
6.2 Vessel equipment in accordance with Article 31.01. The vessel complies ^{*)} / does not comply ^{*)} with Article 31.02 (Standard S1 ^{*)} / Article 31.03 (Standard S2 ^{*)} . [In accordance with Article 19.05 of the Regulations for Rhine navigation personnel / In accordance with national or international requirements], the minimum crew needs to be increased as follows ^{*)} / does not need to be increased ^{*)} :																		
<table border="1" style="width:100%; border-collapse: collapse; margin-bottom: 10px;"> <tr> <td style="width:50%;"></td> <td align="center" colspan="3">Operating modes¹</td> </tr> <tr> <td></td> <td style="width:16.6%;"></td> <td style="width:16.6%;"></td> <td style="width:16.6%;"></td> </tr> <tr> <td></td> <td align="center">.....</td> <td align="center">.....</td> <td align="center">.....</td> </tr> <tr> <td></td> <td align="center">.....</td> <td align="center">.....</td> <td align="center">.....</td> </tr> </table> Observations and special conditions:				Operating modes ¹							
	Operating modes ¹																	
															
															
6.3 Minimum crew [according to Article 19.06 of the Regulations for Rhine navigation personnel / in accordance with national or international requirements]:																		
7. Liquefied gas installation(s) Attestation valid until																		
8. Special conditions																		
[9. Carriage of dangerous goods, see Provisional certificate of approval ¹⁾]																		

¹ The Rhine inspection certificate will refer to: boatman, boatman replaced by an able boatman; operating modes A1, A2 and B

10. Validity
Provisional inland navigation vessel certificate is valid until
for navigation^{*)} / for a single voyage^{*)} (Date)
- on the Rhine^{*)}
between^{*)}
- on EU waterways in Zone(s)^{*)}
- on the waterways in Zone(s)^{*)}
in [Name of States^{*)}]
.....
except for:
- on the following waterways in [Name of the State^{*)}].
.....
.....

11. Place, date Inspection body
Stamp
.....
.....
(Signature)
.....

^{*)} Delete as appropriate

Section III
Model of supplementary Union inland navigation certificate

Annex to inland navigation vessel certificate No

Supplementary Union inland navigation certificate

Name of State / Seal

Name and address of the competent authority issuing the supplementary certificate

1. Name of vessel:
2. Unique European vessel identification number:
3. Place of registration and registration number:
4. Country of registration and/or home port: ⁽¹⁾
5. Having regard to the inland navigation vessel certificate No
 dated valid until
6. Having regard to the result of the inspection
 on
7. the abovementioned vessel is deemed fit to operate on the EU waterways of Zone(s)

8. This supplementary certificate expires on
9. Issued in, on
- 10.

Stamp

.....
 (Inspection body)

.....
 (Signature)

⁽¹⁾ Delete as appropriate.

Annex to inland navigation vessel certificate No

11.

		Zone and / or waterways ⁽¹⁾				
		4	3	2	1	
Freeboard (cm)	with hold closed					
	with hold open					

12. Derogations from inland navigation vessel certificate No

.....

13. The entries concerning the number of crew members in the inland navigation vessel certificate do not apply⁽¹⁾.

14. Having regard to inland navigation vessel certificate No.....

dated valid until

Having regard to the result of the inspection ,
 on

This supplementary certificate is extended/renewed ⁽¹⁾ until

.....

..... ,
 (Place) (Date)

.....
 (Inspection body)

Stamp

.....
 (Signature)

⁽¹⁾ Delete as appropriate.

Section IV
Model of certificate for sea-going vessel operating on the Rhine

Name of State / Seal

Certificate for sea-going vessel operating on the Rhine
n°

The inspection body hereby certifies that the seagoing vessel

Name:

Vessel registration number or letters:

Place of registration:

Year of construction:

Vessel length:

once the inspection has been carried out, the is recognised as fit to navigate the Rhine and is authorised to do so subject to the special conditions stipulated below.

Special conditions:
.....
.....
.....

This certificate is only valid on condition that the vessel is in possession of valid maritime or coastal navigation certificates and shall not be valid later than

.....,
(Place) (Date)

Stamp

.....
(Inspection body)
.....
(Signature)

Section V
Model annex “Traditional craft” to the inland navigation certificate according to Chapter 24

<p>Traditional craft Annex</p> <p>Name of State / Seal</p> <p>Annex to the inland navigation vessel certificate No</p>									
<p>1. Name of the traditional craft: </p>	<p>2. Unique European Vessel Identification Number </p>								
<p>3. Type of craft before the recognition </p>	<p>4. Historical time period </p>								
<p>5. The conformity of the traditional craft described above has been established, based on an inspection of, as well as the expert report of the heritage conservation authority / of the traditional craft expert^{*)} dated with</p> <ul style="list-style-type: none"> - the deviations listed in item 6, and - the additional requirements given in item 7 <p>deemed appropriate.</p>									
<table style="width: 100%; border: none;"> <tr> <td style="width: 50%; text-align: center;"> (Place) </td> <td style="width: 50%; text-align: center;"> (date) </td> </tr> <tr> <td style="text-align: center; vertical-align: middle;"> Stamp </td> <td style="text-align: center;"> Inspection body </td> </tr> <tr> <td></td> <td style="text-align: center;"> (signature) </td> </tr> <tr> <td></td> <td style="text-align: center;"> Name/address of the traditional craft expert </td> </tr> </table>	 (Place) (date)	Stamp Inspection body	 (signature)	 Name/address of the traditional craft expert
..... (Place) (date)								
Stamp Inspection body								
 (signature)								
 Name/address of the traditional craft expert								
<p>^{*)} Delete as appropriate.</p>									

Section VI
Model of register of inland navigation vessel certificates

Register of inland navigation vessel certificates

Competent authority/Inspection body

Register of certificates

Year

(Left-hand page)

Inland navigation vessel certificates			Name of vessel	Unique European vessel identification number	Owner		Vessel register		Type of vessel
No	Day	Month			Name	Address	Place	No	





(right-hand page)



Deadweight according to measurement certificate or displacement*)			Zones or stretch of inland waterway, where appropriate		Endorsements concerning periodical or special inspections, withdrawal and annulment of the certificate	Certificate valid until	Other comments
Date of the certificate	Measurement sign	t or m ³	from	to			

*) If no measurement certificate is available, estimate the deadweight or displacement.

**PART II
ADDITIONAL REQUIREMENTS FOR SPECIFIC EQUIPMENT USED
ON BOARD**

**ANNEX 4
SAFETY SIGNS**

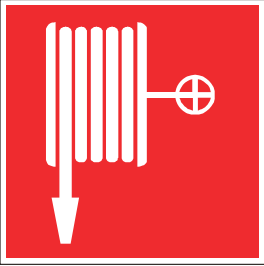
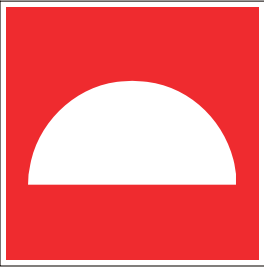
<p>Figure 1 No entry for unauthorised persons</p>		<p>Colour: red / white / black</p>
<p>Figure 2 Fire, naked flame and smoking prohibited</p>		<p>Colour: red / white / black</p>
<p>Figure 3 Fire extinguisher</p>		<p>Colour: red / white</p>
<p>Figure 4 General danger warning</p>		<p>Colour: black / yellow</p>

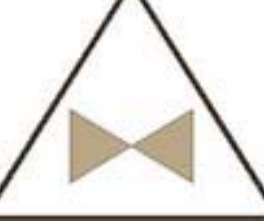
<p>Figure 5 Extinguisher hose</p>		<p>Colour: red / white</p>
<p>Figure 6 Fire-fighting installation</p>		<p>Colour: red / white</p>
<p>Figure 7 Wear acoustic protection device</p>		<p>Colour: blue / white</p>
<p>Figure 8 First-aid kit</p>		<p>Colour: green / white</p>
<p>Figure 9 Quick-closing valve on the tank</p>		<p>Colour: brown / white</p>





<p>Figure 10 Wear life jacket</p>		<p>Colour: blue / white</p>
<p>Figure 11 LNG warning</p>		<p>Colour: black / yellow</p>
<p>Figure 12 Automated external defibrillator</p>		<p>Colour : white/green</p>
<p>Figure 13 Warning for areas where explosive atmospheres may occur</p>		<p>Colour: black / yellow</p>
<p>Figure 14 Hydrogen warning</p>		<p>Colour: black / yellow</p>

Figure 15 Methanol warning		Colour: black / yellow
-------------------------------	---	------------------------

The symbols actually used may slightly differ from or be more detailed than the graphical representations in this Annex, provided the meaning is not changed and differences and modifications do not render the meaning incomprehensible.

ANNEX 5

NAVIGATION AND INFORMATION EQUIPMENT

Contents

Definitions

- Section I** Minimum requirements and test conditions for navigational radar installations in inland navigation
Appendix: Inland ECDIS equipment, standalone equipment connected to the radar equipment
- Section II** Minimum requirements and test conditions for rate-of-turn indicators in inland navigation
Chapter 1 General
Chapter 2 General minimum requirements for rate-of-turn indicators
Chapter 3 Minimum operational requirements for rate-of-turn indicators
Chapter 4 Minimum technical requirements for rate-of-turn indicators
Chapter 5 Test conditions and procedures for rate-of-turn indicators
Appendix: Maximum tolerances for indication errors of rate-of-turn indicators
- Section III** Requirements for installation and performance tests for navigational radar installations and rate-of-turn indicators in inland navigation
- Section IV** Minimum requirements, requirements for installation and performance tests for Inland AIS equipment in inland navigation
- Section V** Minimum requirements, requirements for installation and performance tests for tachographs in inland navigation
- Section VI** Installation and performance certificate for navigational radar installations and rate-of-turn indicators, for Inland AIS equipment and for tachographs in inland navigation

Definitions

1. 'Type test' means the test procedure as referred to in Section I Article 4 or Section II Article 1.03 which the technical service uses to test for compliance with the requirements according to this Annex. The type test forms an integral part of the type-approval.
2. 'Type approval' means the administrative procedure according, by which a Member State confirms that equipment complies with the requirements of this Annex.

3. 'Test certificate' means the document in which the type testing results are laid down.
4. 'Applicant' or 'manufacturer' means any legal or natural person under whose name, trademark or any other form of identification the equipment submitted for testing is manufactured or marketed and who is responsible for all matters as regards the type testing and type-approval procedure in respect of the technical service and the approval authority.
5. 'Technical service' means the institution, authority or organisation that does the type testing.
6. 'Manufacturer's declaration' means the declaration by which a manufacturer gives the assurance that the equipment meets the prevailing minimum requirements and that is identical in every respect to the type submitted for testing.
7. 'Declaration of conformity according to Directive 2014/53/EU¹' means the declaration according to Directive 2014/53/EU Annex II(4), by which the manufacturer confirms that the products in question meet the applicable requirements of the Directive.

¹ Directive 2014/53/EU of the European Parliament and of the Council of 16 April 2014 on the harmonisation of the laws of the Member States relating to the making available on the market of radio equipment and repealing Directive 1999/5/EC (OJ L153, 22.5.2014)

Section I
Minimum requirements and test conditions for navigational radar installations in inland navigation

Article 1
Scope

These provisions set out the minimum requirements for navigational radar installations used in inland navigation as well as the conditions for testing conformity with these minimum requirements.

Article 2
Purpose of the navigational radar installation

The navigational radar installations shall facilitate the navigation of the vessel by providing an intelligible radar picture of its position in relation to buoys shorelines and navigational structures, as well as permitting the reliable and timely recognition of other vessels and obstructions protruding above the surface of the waterway.

Article 3
Minimum requirements

1. Navigational radar installations shall meet the requirements of Directive 2014/53/EU.
2. Navigational radar installations shall also meet the requirements of the European Standard EN 303 676 : 2021
3. (2) above does not apply to Inland ECDIS equipment hardware operated in navigation mode in system configuration 2 or 3 in accordance with ES-RIS, part I, chapters 1 and 2 if a manufacturer's certificate of conformity is produced. This certificate of conformity must confirm that the hardware:
 - a) is designed and manufactured to withstand the typical stresses and environmental conditions prevailing aboard a vessel, without loss of quality or reliability and
 - b) does not interfere with the operation of other onboard communication and navigation equipment.

The first sentence does not apply to visual display units operated in navigation mode in system configuration 3 nor to hardware components used for providing radar information from the radar processor for display on the Inland ECDIS equipment screen.

Article 4*Type tests*

Compliance with the minimum requirements as specified in Article 3(2) shall be established by means of a type test

If the equipment passes the type test the technical service shall issue a test certificate. If the equipment fails to meet the minimum requirements, the applicant shall be notified in writing of the reasons for its rejection.

Article 5*Application for a type test*

1. Applications for a type test of the navigational radar installation shall be submitted to a competent technical service.
2. Each application shall be accompanied by the following documents
 - a) Two detailed technical descriptions;
 - b) two complete sets of installation and service documents;
 - c) two detailed operator's manuals;
 - d) two short operator's manual; and
 - e) where applicable, evidence of previously completed tests.
3. In case it is not intended by the applicant to have the Declaration of Conformity pursuant to Directive 2014/53/EU established concurrently with the type-approval, a Declaration of Conformity shall be submitted together with the application for a type test.

Article 6*Type-approval*

1. Type-approval shall be granted by the competent authority pursuant to the test certificate.
2. Each competent authority or the technical service designated by the competent authority shall be entitled to select equipment from the production series at any time for inspection

If this inspection reveals defects in the equipment, type-approval may be withdrawn.

The type-approval shall be withdrawn by the authority that issued it.

Article 7*Marking of the equipment and type-approval number*

1. Each component of the equipment shall be marked indelibly with the name of the manufacturer, the trade designation of the equipment, the type of equipment and the serial number.
2. The type-approval number assigned by the competent authority shall be affixed indelibly to the display unit in such a way that it remains clearly visible after the equipment has been installed.

Composition of a type-approval number: R-NN-NNN or e-NN-NNN

R = Rhine

e = European Union

NN = number for the country of type-approval, where

01	=	Germany	19	=	Romania
02	=	France	20	=	Poland
03	=	Italy	21	=	Portugal
04	=	Netherlands	23	=	Greece
05	=	Sweden	24	=	Ireland
06	=	Belgium	25	=	Croatia
07	=	Hungary	26	=	Slovenia
08	=	Czech Republic	27	=	Slovakia
09	=	Spain	29	=	Estonia
11	=	United Kingdom	32	=	Latvia
12	=	Austria	34	=	Bulgaria
13	=	Luxembourg	36	=	Lithuania
14	=	Switzerland	49	=	Cyprus
17	=	Finland	50	=	Malta
18	=	Denmark			

NNN = three-digit number, to be determined by the competent authority.

- The type-approval number shall be used only in conjunction with the associated type-approval. It shall be the responsibility of the applicant to produce and affix the type-approval number.

Article 8

Manufacturer's declaration

Each unit of equipment shall be accompanied by a manufacturer's declaration.

Article 9

Modifications to type-approved equipment

- Any modification made to equipment already approved shall cause the type-approval to be forfeit.

Whenever modifications are planned, details shall be sent in writing to the competent technical service.

- The competent authority for the type-approval shall decide following consultation with the technical service whether the type-approval still applies or whether an inspection or new type test is necessary

If a new type-approval is granted, a new type-approval number shall be assigned.

Appendix

Figure 1: Inland ECDIS equipment, standalone equipment connected to the radar equipment (system configuration 2)

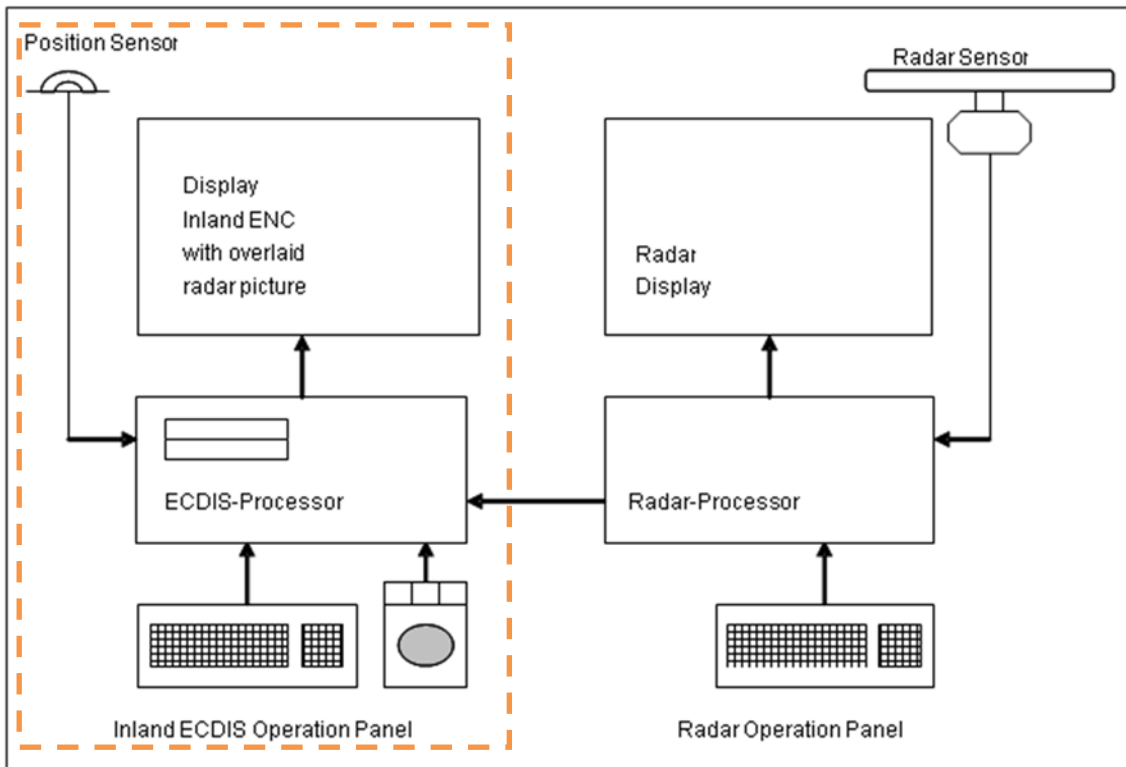
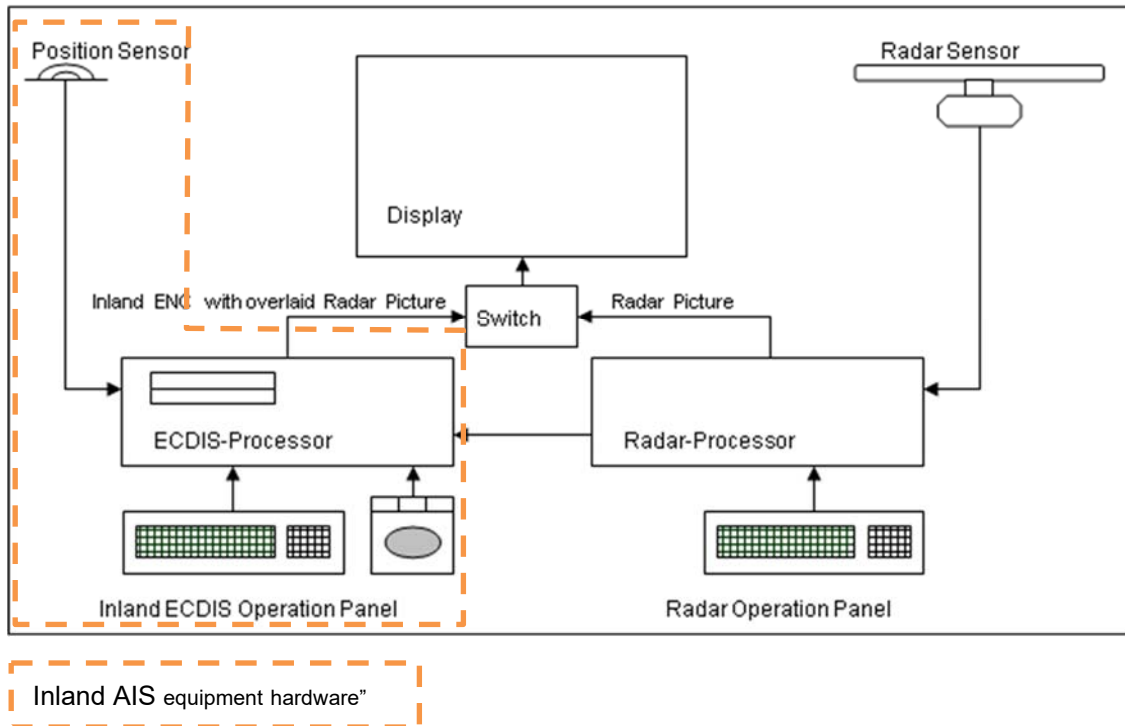

Figure 2: Inland ECDIS equipment, standalone equipment connected to the radar installation and shared monitor (system configuration 3)



Section II
Minimum requirements and test conditions for rate-of-turn indicators in inland navigation

Chapter 1
General

Article 1.01
Scope

These provisions set out the minimum requirements for rate-of-turn indicators in inland navigation, as well as the conditions for testing conformity with these minimum requirements.

Article 1.02
Purpose of the rate-of-turn indicator

The rate-of-turn indicator is intended to facilitate radar navigation, and to measure and indicate the rate of turn of the vessel to port or starboard.

Article 1.03
Type test

1. Compliance with the minimum requirements for rate-of-turn indicators pursuant to Chapters 2 to 4 shall be established by means of a type test.
2. If the equipment passes the type test the technical service shall issue a test certificate. If the equipment fails to meet the minimum requirements, the applicant shall be notified in writing of the reasons for its rejection.

Article 1.04
Application for a type test

1. Applications for a type test of a rate-of-turn indicator shall be submitted to a competent technical service.
2. Each application shall be accompanied by the following documents:
 - a) two detailed technical descriptions;
 - b) two complete sets of installation and service documents
 - c) two operating instructions.
3. By means of tests, the applicant shall establish or have it established that the equipment meets the minimum requirements of these provisions.

The results of the test and the measurement reports shall be attached to the application.

These documents and the information obtained during testing shall be kept by the competent authority.

Article 1.05
Type approval

1. Type approval shall be granted by the competent authority pursuant to the test certificate.
2. Each competent authority or the technical service designated by the competent authority shall be entitled to select equipment from the production series at any time for inspection.

If this inspection reveals defects in the equipment, type-approval may be withdrawn.

The type-approval shall be withdrawn by the authority that issued it.

Article 1.06
Marking of the equipment and type-approval number

1. Each component of the equipment shall be marked indelibly with the name of the manufacturer, the trade designation of the equipment, the type of equipment and the serial number.
2. The type-approval number assigned by the competent authority shall be affixed indelibly to the control unit in such a way that it remains clearly visible after the equipment has been installed.

Composition of a type-approval number: R-NN-NNN or e-NN-NNN

R = Rhine
e = European Union
NN = number for the country of type-approval, where

01	=	Germany	19	=	Romania
02	=	France	20	=	Poland
03	=	Italy	21	=	Portugal
04	=	Netherlands	23	=	Greece
05	=	Sweden	24	=	Ireland
06	=	Belgium	25	=	Croatia
07	=	Hungary	26	=	Slovenia
08	=	Czech Republic	27	=	Slovakia
09	=	Spain	29	=	Estonia
11	=	United Kingdom	32	=	Latvia
12	=	Austria	34	=	Bulgaria
13	=	Luxembourg	36	=	Lithuania
14	=	Switzerland	49	=	Cyprus
17	=	Finland	50	=	Malta
18	=	Denmark			

NNN = three-digit number, to be determined by the competent authority

3. The type-approval number shall be used only in conjunction with the associated type-approval. It shall be the responsibility of the applicant to produce and affix the type-approval number.

Article 1.07
Manufacturer's declaration

Each unit of equipment shall be accompanied by a manufacturer's declaration.

Article 1.08
Modifications to type-approved equipment

1. Any modification made to equipment already approved shall cause the type-approval to be forfeit.

Whenever modifications are planned, details shall be sent in writing to the competent technical service.
2. The competent authority for the type-approval shall decide following consultation with the technical service whether the type-approval still applies or whether an inspection or new type test is necessary.

If a new type-approval is granted, a new type-approval number shall be assigned.

Chapter 2
General minimum requirements for rate-of-turn indicators

Article 2.01
Construction, design

1. Rate-of-turn indicators shall be suitable for operation on board inland navigation vessels.
2. The construction and design of the equipment shall be in accordance with current good engineering practice, both mechanically and electrically.
3. In the absence of any specific provision in this Standard, the requirements and test methods contained in European Standard EN 60945 : 2002 shall apply to power supply, safety, mutual interference of ship borne equipment, compass safe distance, resistance to climatic influences, mechanical strength, environmental influences, audible noise emission and equipment markings.

The equipment shall satisfy all requirements of this Annex at ambient temperatures between 0 °C and + 40 °C.

Article 2.02*Spurious emissions and electromagnetic compatibility*

1. General requirements

Rate-of-turn indicators shall meet the requirements of Directive 2014/30/EU¹.

2. Spurious emissions

In the frequency ranges of 156-165 MHz, 450-470 MHz and 1,53-1,544 GHz, the field strength shall not exceed a value of 15 µV/m. These field strengths shall apply at a test distance of 3 metres from the equipment under test.

Article 2.03*Operation*

1. The equipment shall not have more control units than are necessary for its correct operation.

The design, markings and manipulation of the control units shall be such as to permit their simple, unambiguous and fast operation.

Their arrangement shall be such as to prevent operational mistakes as far as possible

Control units that are not necessary for normal operation shall not be immediately accessible.

2. All control units and indicators shall be provided with symbols and/or markings in English. Symbols shall meet the requirements of International Standard IEC 60417 : 2002 DB (graphical symbols for use on electrical equipment).

All numerals and letters shall be at least 4 mm high. If it can be demonstrated that, for technical reasons, numerals and letters 4 mm high are not possible and if for the purposes of operation smaller numerals and letters are acceptable, a reduction to 3 mm shall be allowed.

3. The equipment shall be designed in such a way that operating mistakes cannot cause its failure.

4. Any functions over and above the minimum requirements, such as facilities for connection to other equipment, shall be provided in such a way that the equipment meets the minimum requirements under all conditions.

Article 2.04*Operator's manual*

A detailed operator's manual shall be supplied with each unit. It shall be available in Dutch, English, French and German and shall contain at least the following information:

- a) activation and operation;
- b) maintenance and servicing;
- c) general safety provisions.

¹ Directive 2014/30/EU of the European Parliament and of the Council of 26 February 2014 on the harmonisation of the laws of the Member States relating to electromagnetic compatibility (OJ L 96, 29.3.2014).

Article 2.05
Installation of the sensor

The direction of installation in relation to the keel line shall be indicated on the rate-of-turn indicator's sensor unit. Installation instructions shall be provided to ensure maximum insensitivity to other normal movements of the vessel.

Chapter 3
Minimum operational requirements for rate-of-turn indicators**Article 3.01**
Operational readiness of the rate-of-turn indicator

1. From a cold start, the rate-of-turn indicator shall be fully operational within 4 minutes and shall operate to within the required accuracy tolerances.
2. A warning signal shall indicate that the indicator is switched on. It shall be possible to observe and operate the rate-of-turn indicator simultaneously.
3. Cordless remote controls shall not be permitted.

Article 3.02
Indication of the rate of turn

1. The rate of turn shall be indicated on a linear graduated scale having the zero point situated in the middle. It shall be possible to read the direction and extent of the rate of turn with the necessary accuracy. Indicators other than needle indicators and bar-graphs shall not be permitted.
2. The indicator scale shall be at least 20 cm long and may be circular or rectilinear.

Rectilinear scales may be arranged horizontally only.
3. Digital-only indicators will not be accepted.

Article 3.03
Measuring ranges

Rate-of-turn indicators may be provided with one or more measuring ranges. The following measuring ranges are recommended:

30°/min
60°/min
90°/min
180°/min
300°/min.

Article 3.04*Accuracy of the indicated rate of turn*

The indicated rate of turn shall not differ by more than 2 % from the measurable maximum value or by more than 10 % from the actual value; whichever is the greater (see Appendix).

Article 3.05*Sensitivity*

The operating threshold shall be less than or equal to a change in angular speed equivalent to 1 % of the indicated value.

Article 3.06*Monitoring of operation*

1. If the rate-of-turn indicator does not operate within the required accuracy range, this shall be indicated.
2. If a gyroscope is used, any critical fall in the rate of rotation of the gyroscope shall be signalled by an indicator. A critical fall in the rate of rotation of the gyroscope is one which lowers accuracy by 10 %.

Article 3.07*Insensitivity to normal movements of the vessel*

1. Rolling of the vessel of up to 10° at a rate of turn of up to 4°/s shall not give rise to measurement errors in excess of the stipulated tolerances.
2. Impacts such as those that may occur during berthing shall not give rise to measurement errors in excess of the stipulated tolerances.

Article 3.08*Insensitivity to magnetic fields*

The rate-of-turn indicator shall be insensitive to magnetic fields which typically occur on board the vessel.

Article 3.09*Slave indicators*

Slave indicators shall comply with all requirements applicable to rate-of-turn indicators

Chapter 4
Minimum technical requirements for rate-of-turn indicators**Article 4.01***Operation*

1. All controls shall be so arranged that during their operation no information is concealed from view and radar navigation remains unimpaired.
2. All control units and indicators shall be provided with a dazzle-free source of lighting appropriate for all ambient lighting conditions and adjustable down to zero by means of an independent control.
3. Adjustment of control units shall be such that movements to the right or upwards have a positive effect on the variable and movements to the left or downwards a negative effect.
4. If push-buttons are used, it shall be possible to locate and operate them by touch. They shall also have clearly perceptible contact release. If pushbuttons have multiple functions, it must be apparent which hierarchical level is active.

Article 4.02*Damping devices*

1. The sensor system shall be damped for critical values. The damping constant (63 % of the limit value) shall not exceed 0,4 seconds.
2. The indicator shall be damped for critical values.
Control units for increasing damping shall be permitted.
Under no circumstances shall the damping constant exceed 5 seconds.

Article 4.03*Connection of additional equipment*

1. If the rate-of-turn indicator can be connected to slave indicators or similar equipment, the rate-of-turn indication shall remain usable as an analogue or digital electric signal. Digital interfaces must be constructed as per (2).

The analogue rate-of-turn signal shall continue to be indicated with galvanic earth insulation and the equivalent to an analogue voltage of $20 \text{ mV}/^\circ/\text{min} \pm 5 \%$ and a maximum internal resistance of 100Ω .

Polarity shall be positive when the vessel is turning to starboard and negative when it is turning to port.

The operating threshold shall not exceed 0,3°/min.

Zero error shall not exceed 1°/min at temperatures from 0 °C to 40 °C.

With the indicator switched on and the sensor not exposed to the effects of movement, the spurious voltage at the output signal measured with a 10 Hz pass-band low-pass filter shall not exceed 10 mV.

The rate-of-turn signal shall be received without additional damping beyond the limits referred to in Article 4.02(1).

2. A digital interface shall be designed pursuant to European Standards EN 61162-1 : 2016, EN 61162-2 : 1998 and EN 61162-3 : 2009.
3. An external alarm switch shall be provided. The switch shall be installed as a galvanic insulation break-switch for the indicator.

The external alarm shall be triggered by contact closure:

- a) if the rate-of-turn indicator is disconnected; or
- b) if the rate-of-turn indicator is not in operation; or
- c) if the operating control has reacted following an excessive error (Article 3.06).

Chapter 5

Test conditions and procedures for rate-of-turn indicators

Article 5.01

Safety, load capacity and electromagnetic compatibility

Power supply, safety, mutual interference of ship borne equipment, compass safe distance, resistance to climatic influences, mechanical strength, environmental impact, audible noise emission and electromagnetic compatibility shall be tested in accordance with European Standard EN 60945 : 2002.

Article 5.02

Spurious emissions

Spurious emissions shall be measured in accordance with European Standard EN 60945 : 2002 in the frequency range of 30 to 2000 MHz.

The requirements of Article 2.02(2) shall be met.

Article 5.03

Test procedure

1. Rate-of-turn indicators shall be tested under nominal and boundary conditions. In this regard, the influence of the operating voltage and of the ambient temperature shall be tested as far as the prescribed limit value.

In addition, radio transmitters shall be used to set up the maximum magnetic fields in the vicinity of the indicators.

- Under the conditions described in (1), indicator errors shall remain within the tolerances indicated in the Appendix.

All minimum requirements of Chapters 2 to 4 shall be met.

Appendix
Figure 1: Maximum tolerances for indication errors
of rate-of-turn indicators

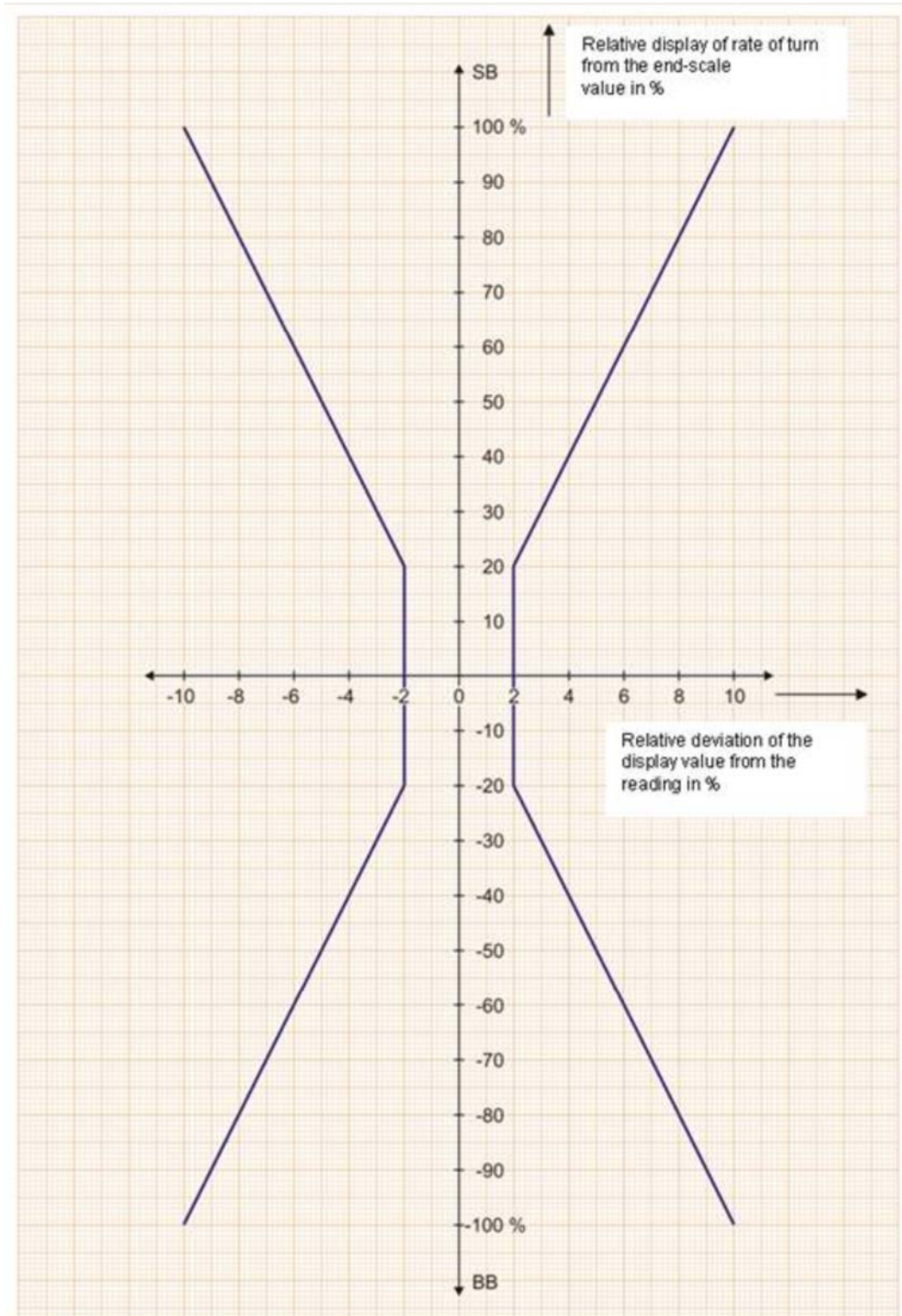

Section III
Requirements for installation and performance tests for navigational radar installations and rate-of-turn indicators in inland navigation

Article 1
General

1. Installation and performance tests of navigational radar installations and rate-of-turn indicator systems must take place according to the following provisions.
2. Only equipment with a type-approval according to Section I Article 6 or Section II Article 1.05, or with a type-approval recognised as equivalent shall be authorised for installation.
3. If data from external sensors for geo-spatial positioning or determining the heading are used by a navigational radar installation, these sensors must be type-approved in accordance with the following maritime Standards:

Sensor	Minimum requirements in accordance with	
	Standard (IMO)	ISO / IEC Standard
GPS	MSC.112(73) ¹	IEC 61108-1 : 2003
DGPS/DGLONASS	MSC.114(73) ²	IEC 61108-4 : 2004
Galileo	MSC.233(82) ³	IEC 61108-3 : 2010
Heading/GPS Compass	MSC.116(73) ⁴	ISO 22090-3 : 2014 Part 3: GNSS principles

4. If an Inland AIS equipment is connected to a navigational radar installation not fitted with an electronic inland navigation card for displaying AIS symbols, an approved compass must also be connected in order to comply with the requirement in Annex 5 Section I (2).

Article 2
Approved specialist firms

1. The installation, replacement, repair or maintenance of navigational radar installations and rate-of-turn indicators shall be carried out only by specialist firms approved by the competent authority.
2. Approval may be withdrawn by the competent authority.

¹ MSC.112(73) adopted on 1 December 2000- Revised Performance Standards for Shipborne Global Positioning System (GPS) Receiver Equipment.

² MSC.114(73) adopted on 1 December 2000 - Revised Performance Standards for Shipborne DGPS and DGLONASS Maritime Radio Beacon Receiver Equipment.

³ MSC.233(82) adopted on 5 December 2006 - Performance Standards for Shipborne Galileo Receiver Equipment.

⁴ MSC.116(73) adopted on 1 December 2000 - Performance Standards for marine transmitting heading devices (THDs).

Article 3*Installation of the radar antenna*

1. The radar antenna shall be installed as close as possible to the fore-and-aft-line. There shall be no obstruction in the vicinity of the antenna causing false echoes or unwanted shadows; if necessary, the antenna shall be mounted on the forecastle. The mounting and attachment of the radar antenna in its operational position shall be sufficiently stable to enable the navigational radar installation to perform within the required accuracy limits.
2. After the angular error in the mounting has been corrected and the equipment has been switched on, the difference between lubber line and fore-and-aft-line shall not be greater than 1°.

Article 4*Installation of the display unit and the control unit*

1. The display unit and control unit shall be installed in the wheelhouse in such a way that the evaluation of the radar image and the operation of the navigational radar installation present no difficulty. The azimuthal orientation of the radar image shall be in accordance with the normal situation of the surroundings. Holders and adjustable consoles shall be constructed in a way that they can be fixed in each position free of vibration.
2. During radar navigation, artificial lighting shall not be reflected in the direction of the radar operator.
3. When the control unit is not part of the display unit, it shall be located in housing within 1 metre of the display unit. Cordless remote controls shall not be permitted.
4. If slave indicators are installed, they shall satisfy the requirements which apply to navigational radar installations.

Article 5*Installation of the rate-of-turn indicator*

1. The rate-of-turn indicator shall be located ahead of the helmsman and within their field of vision.
2. The sensor system shall be installed as far as possible amidships, horizontal and aligned with the ship's fore-and aft-line. The installation site shall as far as possible be free of vibration and be liable only to modest temperature variations. The indicator unit shall if possible be installed directly above the radar display.
3. If slave indicators are installed, they shall satisfy the requirements which apply to rate-of-turn indicators.

Article 6*Installation of the position sensor*

For inland ECDIS equipment which is operated in navigation mode, the position sensor (e.g. DGNS antenna) must be installed in such a way as to ensure that it operates with the greatest possible degree of accuracy and is not adversely affected by superstructures and transmitting equipment on board ship.

Article 7*Installation and performance test*

Before the equipment is switched on for the first time after installation, in case of periodical inspection in order to extend the validity of the inland navigation certificate, as well as after each modification of the vessel likely to affect the operating conditions of the equipment, an installation and performance test shall be carried out by the competent authority or by a specialist firm authorised in accordance with Article 2. The following conditions are to be complied with when installing navigational radar equipment and rate-of-turn indicators:

- a) The device is to be connected directly to a power supply system in accordance with Article 10.02. The device shall feature a power circuit with its own safety device having regard to Article 10.12(2)(a);
- b) the operating voltage shall be within the tolerance;
- c) the cabling and its installation shall satisfy the provisions of this Standard and, if applicable ADN;
- d) the rate of antenna revolutions shall reach at least 24 rpm;
- e) there shall be no obstruction in the vicinity of the antenna which impairs navigation;
- f) the safety switch of the antenna, if provided, shall be in good working order;
- g) the arrangement of display units, rate-of-turn indicators and control units shall be ergonomic and user-friendly;
- h) the lubber line of the navigational radar installation shall not deviate from the ship's fore-and-aft-line by more than 1°;
- i) the accuracy of the range and azimuthal displays shall satisfy the requirements (measurements using known targets);
- j) linearity in short ranges shall be correct (pushing and pulling);
- k) the displayed minimum range shall be 15 metres or less;
- l) the centre of the picture shall be visible and its diameter shall not exceed 1 mm;
- m) false echoes caused by reflections and unwanted shadows on the lubber line shall not occur or shall not impair the safety of navigation;
- n) sea-clutter and rain-clutter suppressors (STC and FTC preset) and the associated controls shall perform correctly;
- o) the gain adjustment shall be in proper working order;
- p) focus and picture definition shall be correct;
- q) the ship's turning direction shall be as indicated on the rate-of-turn indicator and the zero position at dead ahead shall be correct;
- r) the navigational radar installation shall not be sensitive to transmissions by the ship's radio equipment or to interference from other on-board sources;
- s) the navigational radar installation or rate-of-turn indicator shall not interfere with other on-board equipment.

Furthermore, in the case of inland ECDIS equipment:

- t) the statistical positional error affecting the chart shall not exceed 2 m;
- u) the statistical phase angle error affecting the chart shall not exceed 1°.

Article 8*Installation and performance certificate*

After successful completion of a test in accordance with Article 7, the competent authority or the approved specialist firm shall issue a certificate based on the model according to Annex 5 Section VI. This certificate shall be kept permanently on board.

If the test conditions have not been met, a list of defects shall be drawn up. Any existing certificate shall be withdrawn or sent to the competent authority by the approved specialist firm.

Section IV

Minimum requirements, requirements for installation and performance tests for Inland AIS equipment in inland navigation

Article 1

Approval of Inland AIS equipment

Inland AIS equipment shall comply with the requirements of ES-RIS, parts II and VI. Compliance is proven by a type-approval issued by a competent authority.

Article 2

Installation and performance tests of shipborne Inland AIS equipment

The following conditions are to be complied with when installing shipborne Inland AIS equipment:

1. Shipborne Inland AIS equipment shall only be installed by specialist firms approved by the competent authority.
2. The Inland AIS equipment shall be installed at an appropriate location in such way that
 - a) it does not disturb the operation of other navigation equipment such as navigational radar installations or radiotelephone installations and
 - b) conversely other navigation equipment does not disturb the correct operation of the Inland AIS equipment.
3. The MKD (Minimum Keyboard and Display) shall be accessible to the helmsman. The MKD Information shall be located within the helmsman's direct field of view. Other devices used for navigation purposes may however take priority as regards their direct visibility. It shall be possible to establish visually whether the equipment is operating. All warning indicator lights shall remain visible after installation.
4. The equipment shall be connected directly to a power supply system in accordance with Article 10.02. The equipment shall feature a power circuit with its own circuit-breaker having regard to Article 10.12(2)(a) and be capable of being supplied with power at all times.
5. Inland AIS equipment antennas shall be installed and properly connected to the equipment, following the manufacturer's instructions, so as to ensure that this equipment operates reliably under all normal conditions of use. Appropriate cable types shall be used to connect the antennas, taking into account the environmental conditions.

The VHF antenna of the Inland AIS equipment shall:

- a) be omni-directional with a vertical polarization;
- b) be installed in such a way that the potential electromagnetic interference with other high-power energy sources, such as navigational radar installations and other VHF antennas, is as low as technically and physically possible.

Every Inland AIS equipment shall be connected to its own VHF antenna. Sharing the cables of VHF antennas for radiotelephone installations and Inland AIS equipment is not allowed.

The internal GNSS sensor of the Inland AIS equipment shall be connected to a suitable GNSS antenna, even if the Inland AIS equipment is connected to an external GNSS position sensor.

6. If data from external sensors for geo-spatial positioning or determining the heading are used by an Inland AIS equipment, these sensors must be type-approved in accordance with the following maritime Standards:

Sensor	Minimum requirements in accordance with	
	Standard (IMO)	ISO/IEC Standard
GPS	MSC.112(73) ¹	IEC 61108-1 : 2003
DGPS/DGLONASS	MSC.114(73) ²	IEC 61108-4 : 2004
Galileo	MSC.233(82) ³	IEC 61108-3 : 2010
Heading/GPS Compass	MSC.116(73) ⁴	ISO 22090-3 : 2014 Part 3: GNSS principles

7. If the Inland AIS equipment is connected to the blue panel prescribed by the applicable navigational authority regulations of the Member States, the real state of the blue panel shall be determined and displayed under all normal conditions of use.

The status “not available” shall be used if the blue panel is not connected to the Inland AIS equipment.

8. Before the equipment is put into service after installation, in case of periodical inspection in order to extend the validity of the inland navigation certificate, as well as after each modification of the vessel likely to affect the operating conditions of the equipment, an installation and performance test shall be carried out by the competent authority or approved specialist firm.
9. The approved specialist firm that has carried out the installation and performance test issues a certificate in accordance with Annex 5, Section VI, regarding the specific characteristics and correct operation of the Inland AIS equipment.
10. The certificate shall be permanently retained onboard.
11. User instructions shall be handed over for retention on board. This shall be mentioned on the shipboard installation certificate.
12. When two Inland AIS equipment are installed on the same vessel, then they shall have corresponding configurations.
13. The requirements laid down in (2), (5), (7) and (12) shall apply only to Inland AIS equipment installed after 1 January 2026, unless the inspection body detects malfunctions in equipment already installed before that date.

¹ MSC.112(73) adopted on 1 December 2000- Revised Performance Standards for Shipborne Global Positioning System (GPS) Receiver Equipment.

² MSC.114(73) adopted on 1 December 2000 - Revised Performance Standards for Shipborne DGPS and DGLONASS Maritime Radio Beacon Receiver Equipment.

³ MSC.233(82) adopted on 5 December 2006 - Performance Standards for Shipborne Galileo Receiver Equipment.

⁴ MSC.116(73) adopted on 1 December 2000 - Performance Standards for marine transmitting heading devices (THDs).

Section V
Minimum requirements, requirements for installation and performance tests for tachographs in inland navigation

Article 1
Approval of tachographs

The tachographs must comply with the requirements of this section. Compliance is certified by an examination of type-approval by a competent authority.

Article 2
Requirements to be complied with by tachographs

1. Ascertaining the vessel's navigation time

To determine navigation according to the criterion yes/no, the rotation of the propeller must be measured at an appropriate place. Where propulsion is other than by propeller, the vessel's movement must be ascertained in an equivalent manner at appropriate place. Where there are two or more propeller shafts, it must be ensured that recording will operate even if only one of the shafts is turning.

2. Vessel identification

The unique European vessel identification number or official vessel number must be indelibly recorded on the data medium and be readable from it.

3. Recording on the data medium

The following items of information must be recorded on the data medium such as to be tamper-proof and readable from it: the vessel's operating mode, the date and time at which the tachograph was operating and ceased operating, the insertion and removal of the data medium and other actions performed on the device. The tachograph must automatically record the time, insertion and removal of the data medium, the opening and closure of the device as well as any interruption to its power supply.

4. Recording time per day

The date and time at which the shaft starts and stops rotating must be continuously recorded daily between 00.00 and 24.00.

5. Reading the recording

The recording must be unequivocal, easy to read and clearly comprehensible. It must be possible to read the recording at any moment without any special auxiliary devices.

6. Printing the recording

It must be possible for the recordings to be provided at any time as a readily transparent printout.

7. Security of the recording

The rotation of the propeller must be recorded in a way that cannot be tampered with.

8. Accuracy of the recording

The rotation of the propeller must be recorded in a way that is accurate in time. The recording must be readable with an accuracy of 5 minutes.

9. Operating voltages

Voltage fluctuations of up to $\pm 10\%$ of the nominal value must not hinder the proper functioning of the device. Moreover, the installation must be capable of withstanding a 25 % increase in the supply voltage relative to the nominal voltage without its serviceability being impaired in any way.

10. Operating conditions

The devices or device components must operate faultlessly under the following conditions:

- ambient temperature: 0 °C to + 40 °C
- humidity: up to 85 % relative air humidity
- type of electrical protection: IP 54 in accordance with the European Standard EN 60529 : 2014
- oil resistance: although intended to be installed in the engine room, the devices or device components must be oil resistant
- permissible time recording tolerances: ± 2 minutes per 24 hours.

Article 3

Requirements for installing shipboard tachographs

The following conditions are to be complied with when installing shipboard tachographs:

1. Shipboard tachographs can only be installed by specialist firms approved by the competent authority.
2. The tachograph must be installed in the wheelhouse or other readily accessible location.
3. It must be possible to establish visually whether the equipment is operating. The equipment is to be connected directly to a power supply system in accordance with Article 10.02. The equipment shall feature a power circuit with its own safety device having regard to Article 10.12(2)(a) and be capable of being provided with power at all times. The tachograph is to be checked immediately after being switched on to ensure it is working properly.
4. Information concerning the vessel's movement, namely whether the vessel is "underway" or "not underway" is derived from the movement of the propulsion system. The corresponding signal must originate from the rotation of the propeller, from the propeller shaft or from the operation of the propulsion machinery. In the case of different propulsion systems, an equivalent solution must be achieved.
5. The technical equipment for capturing the movement of the vessel must be installed so as to be as operationally reliable as possible and immune from unauthorised interventions. To this end, the signal transmission circuit (including the signal generator and device inlet terminal), from the propulsion system to the device must be protected by appropriate means with monitoring to detect any interruption of the circuit. Appropriate for this purpose are for example seals bearing identification markings and visible cable runs or monitoring circuits.

6. Upon completion of the installation, the specialist firm which has carried out or supervised the installation carries out an operating test. It issues a certificate attesting to the characteristics of the installation (in particular the location and type of seals and their markings, location and type of monitoring equipment) and that it is operating correctly; the certificate must also provide information on the type of approved device. A new operating test is required after any replacement, modification or repair; this test must be referred to on the certificate.

The certificate must at a minimum comprise the following data:

- name, address and unique reference of the approved specialist firm that has carried out or supervised the installation;
- name, address and telephone number of the competent authority that approved the company;
- unique European vessel identification number of the vessels or official number of the vessel;
- tachograph type and serial number;
- date of the operating test.

The certificate is valid for 5 years.

The purpose of the certificate is to prove that the device is approved, installed by an approved specialist firm and has been tested for correct operation.

7. The vessel's command must be trained in the use of the device by the approved company and user instructions must be handed over for retention on board. This must be mentioned on the shipboard installation certificate.

Section VI

Installation and performance certificate for navigational radar installations, rate-of-turn indicators, for Inland AIS equipment and for tachographs in inland navigation
(Model)

Vessel name/type:

Unique European vessel identification number:

Vessel owner:

Name:

Address:

Telephone:

Navigational radar installations:

Number:

Item No	Type	Manufacturer	Type-approval number	Serial number

Rate-of-turn indicators:

Number:

Item No	Type	Manufacturer	Type-approval number	Serial number

Inland AIS equipment:

Item No	Type	Manufacturer	Type-approval number	Serial number

Tachographs

...

It is hereby certified that the vessel's navigational radar installations, rate-of-turn indicators and Inland AIS equipment, referred to above, comply with the requirements of Annex 5 of the European Standard laying down technical requirements for inland navigation vessels (ES-TRIN) for the installation and performance testing of navigational radar installations, rate-of-turn indicators and Inland AIS equipment for inland navigation.

Approved specialist firm

Name:

Address:

Telephone:

Stamp
Signature

Place Date

Competent authority

Name:

Address:

Telephone:

ANNEX 6
(LEFT VOID)

ANNEX 7

ON-BOARD SEWAGE TREATMENT PLANTS

Table of contents

Section I	Supplementary provisions
	<ol style="list-style-type: none">1. Marking of on-board sewage treatment plants2. Testing3. Evaluation of conformity of production
Section II	Information document No ... relating to type-approval of on-board sewage treatment plants intended for installation in inland waterway vessels (model)
	Appendix 1 - Main characteristics of the on-board sewage treatment plant type (model)
Section III	Type approval certificate (model)
	Appendix 1 - Test results for type-approval (model)
Section IV	Type approvals' numbering system
Section V	Summary of type-approvals for on-board sewage treatment plant types
Section VI	Summary of on-board sewage treatment plants manufactured (model)
Section VII	Data sheet for on-board sewage treatment plants with type-approval (model)
Section VIII	Test report for on-board sewage treatment plants (model)
Section IX	Test procedure

Section I

Supplementary provisions

1. Marking of on-board sewage treatment plants

- 1.1 The type-tested on-board sewage treatment plant must bear the following information (marking):
- 1.1.1 manufacturer's trademark or trade name;
 - 1.1.2 on-board sewage treatment plant type and serial number of the plant;
 - 1.1.3 number of the type-approval in accordance with Section IV of this Annex;
 - 1.1.4 year of construction of the on-board sewage treatment plant.
- 1.2 The marking in accordance with (1.1) must be durable, clearly legible and indelible throughout the working life of the on-board sewage treatment plant. If adhesive labels or plates are used, they must be affixed so as to stay on throughout the working life of the on-board sewage treatment plant and in such a way that they cannot be removed without being destroyed or rendered indecipherable.
- 1.3 The marking must be affixed to a part of the on-board sewage treatment plant necessary for normal operation of the on-board sewage treatment plant and not normally requiring replacement during the working life of the on-board sewage treatment plant.
- 1.3.1 The marking must be affixed in such a way that it is clearly visible after the on-board sewage treatment plant has been fitted with all the auxiliary equipment necessary for its operation.
 - 1.3.2 If necessary, the on-board sewage treatment plant must bear an additional removable plate made of a durable material which must contain all the information in referred to in (1.1) and which shall be affixed in such a way that that information is clearly legible and easily accessible after the on-board sewage treatment plant has been installed in a craft.
- 1.4 All parts of the on-board sewage treatment plant which may have an effect on the treatment of sewage must be clearly marked and identified.
- 1.5 The exact location of the marking referred to in (1.1) shall be indicated in Section I of the type-approval certificate.

2. Testing

The procedure for testing an on-board sewage treatment plant is laid down in Section IX.

3. Evaluation of conformity of production

- 3.1 With regard to the verification of the existence of satisfactory arrangements and procedures for ensuring effective control of production conformity before granting type-approval, the competent authority must accept the manufacturer's registration to harmonised European Standard EN ISO 9001 : 2015 (whose scope covers the production of the on-board sewage treatment plants concerned) or an equivalent accreditation standard as satisfying the requirements. The manufacturer must provide details of the registration and undertake to inform the competent authority of any revisions to its validity or scope. Appropriate production inspections shall be carried out in order to ensure that the requirements of Article 18.01(2) to (5) are consistently being fulfilled.
- 3.2 The holder of the type-approval must:
- 3.2.1 ensure that procedures are in place for the effective control of the quality of the product;
 - 3.2.2 have access to the testing equipment necessary for checking conformity with each type-approved type;
 - 3.2.3 ensure that the results of the tests are recorded and that these records and the relevant documentation remain available for a period to be agreed with the competent authority;
 - 3.2.4 analyse closely the results of each type of test, in order to verify and ensure the consistency of the on-board sewage treatment plant's characteristics, making allowance for normal variations in series production;
 - 3.2.5 ensure that any samples from on-board sewage treatment plants or test pieces revealing apparent non-conformity in the type of test in question give rise to further sampling and testing, all necessary measures being taken to restore conformity of production.
- 3.3 The competent authority which has granted type-approval may at any time verify the conformity control methods applied at each production works.
- 3.3.1 The test and production documentation shall be made available to the tester at each test.
 - 3.3.2 If the quality of the tests appears unsatisfactory, the following procedure shall be applied:
 - 3.3.2.1 one on-board sewage treatment plant shall be taken from the series and tested by means of random sample measurements in the normal loading condition of the Section IX after one day operation. The treated sewage must according to the test methods in Section IX not exceed the values set out in Article 18.01(2), Table 2.

3.3.2.2 should any on-board sewage treatment plant taken from the series fail to satisfy the requirements laid down in (3.3.2.1) the manufacturer may ask for random sample measurements to be carried out on a number of on-board sewage treatment plants of the same specification taken from the series. This new sample must include the on-board sewage treatment plant originally taken.

The manufacturer shall determine the scope 'n' of the series in consultation with the competent authority. The on-board sewage treatment plants shall undergo testing by means of random sample measurement with the exception of the plant originally taken. The arithmetical mean (\bar{x}) of the results obtained with the random sample of the on-board sewage treatment plant must then be determined. The series production shall be regarded as conforming with requirements if the following condition is fulfilled:

$$\bar{x} + k \cdot S_t \leq L$$

Where:

k : is a statistical factor which is dependent on 'n' and is given in the following table:

n	2	3	4	5	6	7	8	9	10
k	0,973	0,613	0,489	0,421	0,376	0,342	0,317	0,296	0,279
n	11	12	13	14	15	16	17	18	19
k	0,265	0,253	0,242	0,233	0,224	0,216	0,210	0,203	0,198

$$\text{if } n \geq 20, k = \frac{0,860}{\sqrt{n}}$$

$$S_t : \sqrt{\frac{\sum_{i=1}^n (x_i - \bar{x})^2}{n - 1}}$$

where x_i is any individual result obtained from the random sample n

L : is the admissible limit value set out in Article 18.01(2), Table 2, for each pollutant studied;

- 3.3.3 if the values as set out in Article 18.01(2), Table 2 are not complied with, a new test shall be carried out according to (3.3.2.1) and, in case that tests has no positive results, in accordance with (3.3.2.2) a full test is carried out, following the test procedure provided in Annex 9. The limit values as set out in Article 18.01(2), Table 1 may not be exceeded for either the composite sample or the random sample.
- 3.3.4 The competent authority must carry out the tests on on-board sewage treatment plants which are partially or fully functional according to the information supplied by the manufacturer.
- 3.3.5 The normal frequency of tests of conformity of production which the competent authority is entitled to conduct shall be one per year. In case of non-compliance with the requirements of (3.3.3) the competent authority shall ensure that all necessary steps are taken to restore production conformity without delay.

Section II**Information Document No ...¹ relating to type-approval of on-board sewage treatment plants intended for installation in inland waterway vessels
(Model)**

On-board sewage treatment plant type:

0. General

0.1 Make (manufacturer's company name):

0.2 Manufacturer's designation for the on-board sewage treatment plant type:

0.3 Manufacturer's type code corresponding to the information given on the on-board sewage treatment plant:

0.4 Manufacturer's name and address:
Name and address of manufacturer's authorised representative, if any:

0.5 Position, coding and method of attachment of the on-board sewage treatment plant's serial number:

0.6 Position and method of attachment of the type-approval number:

0.7 Address(es) of production works:

Appendices

1. Main characteristics of the on-board sewage treatment plant type
2. Design and dimensioning criteria, dimensioning specifications and regulations applied
3. Schematic diagram of the on-board treatment plant with parts list
4. Schematic diagram of the test plant with parts list
5. Electrical wiring diagrams (P/I diagram)
6. Statement that all specifications regarding the mechanical, electrical and technical safety of sewage treatment plants and specifications concerning ship safety have been observed
7. Characteristics of any parts of the vessel that are connected with the on-board sewage treatment plant
8. Manufacturer's guide to checking the components and parameters of the on-board sewage treatment plant relevant to sewage treatment in accordance with Article 1.01 (9.10)

¹ Information document reference number assigned by the competent authority.

- 9. Photographs of the on-board sewage treatment plant
- 10. Operating concepts⁽¹⁾
 - 10.1 Instructions for manual operation of the on-board sewage treatment plant
 - 10.2 Notes on excess sludge management (discharge intervals)
 - 10.3 Notes on maintenance and repair
 - 10.4 Notes on action necessary in the case of stand-by operation of the on-board sewage treatment plant
 - 10.5 Notes on action necessary in the case of emergency operation of the on-board sewage treatment plant
 - 10.6 Notes on run-down, standstill and restart operation of the on-board sewage treatment plant
 - 10.7 Notes on requirements for pre-treatment of galley waste water
- 11. Other equipment (list here)

Date, signature of on-board sewage treatment plant manufacturer

.....

Appendix 1
Main characteristics of the on-board sewage treatment plant type
(Model)

- 1. Description of the on-board sewage treatment plant**
 - 1.1 Manufacturer:
 - 1.2 Serial number of the plant:
 - 1.3 Mode of treatment: biological or mechanical/chemical ⁽²⁾
 - 1.4 Upstream waste water storage tank? Yes, ... m³ / No⁽²⁾
- 2. Design and dimensioning criteria (including any special installation instructions or restrictions on use)**
 - 2.1
 - 2.2
- 3. Dimensioning of the on-board sewage treatment plant**
 - 3.1 Maximum daily volumetric flow rate of sewage Q_d (m³/d):
 - 3.2 Daily BOD_5 pollution load (kg/d):

¹ Operating phases

The following operating phases shall be defined for testing:

- a) Stand-by operation is when the on-board sewage treatment plant is running but has not been fed with sewage for more than a day. An on-board sewage treatment plant may be in stand-by operation when, for example, the passenger vessel is not in service for an extended period and sits idle at its mooring.
- b) Emergency operation is when individual subassemblies of an on-board sewage treatment plant have malfunctioned, so that the sewage cannot be treated as intended.
- c) Run-down, standstill and restart operation is when an on-board sewage treatment plant is taken out of service for an extended period (winter mooring) and the power supply is switched off, or when the on-board sewage treatment plant is started up again at the beginning of the season.

² Specify as appropriate.

Section III
Type approval certificate
(Model)

Seal of the competent authority

Type approval No.: **Extension No.:**

Notification of
- issuance/extension/refusal/withdrawal¹
of type-approval for an on-board sewage treatment plant type in accordance with the European
Standard laying down technical requirements for inland navigation vessels (ES-TRIN)

Reason for extension, if applicable:

Section I

- 0. General
- 0.1 Make (manufacturer's company name):
- 0.2 Manufacturer's designation for the on-board sewage treatment plant type:
.....
- 0.3 Manufacturer's type code corresponding to the information affixed to the on-board treatment
plant:
.....
Position:
Method of attachment:
- 0.4 Manufacturer's name and address:
.....
Name and address of manufacturer's authorised representative, if any:
.....
- 0.5 Position, coding and method of attachment of the serial number of the on-board sewage
treatment plant:
.....
.....
- 0.6 Position and method of attachment of the type-approval number:
.....
.....
- 0.7 Address(es) of production works:
.....
.....

¹ Specify as appropriate.

Section II

- 1. Any restrictions on use:
- 1.1 Particularities to be observed when installing the on-board sewage treatment plant in a craft:
 - 1.1.1
 - 1.1.2
- 2. Technical service responsible for carrying out the tests¹:
- 3. Date of test report:
- 4. Number of test report:
- 5. The undersigned hereby certifies the accuracy of the manufacturer information in the annexed information document for the above mentioned on-board sewage treatment plant in accordance with Annex 7 Section IX of the European Standard laying down technical requirements for inland navigation vessels (ES-TRIN) and the validity of the annexed test results in relation to the on-board sewage treatment plant type. The sample(s) has (have) been selected by the manufacturer with the agreement of the competent authority and submitted by the manufacturer as the design type of the on-board sewage treatment plant:

 The type-approval is issued/extended/refused/withdrawn²:
 Place:
 Date:
 Signature:

Appendices: Information folder
 Test results (see Appendix 1)

¹ In case tests are made by the competent authority mark 'not relevant'.
² Specify as appropriate.

Appendix 1
Test results for type-approval
(Model)

- 0. General
 - 0.1 Make (manufacturer's company name):
 - 0.2 Manufacturer's designation for the on-board sewage treatment plant type:
- 1. **Information on the implementation of the test(s)¹.**
 - 1.1 Inflow values
 - 1.1.1 Daily volumetric flow rate of sewage Q_d (m³/d):
 - 1.1.2 Daily BOD_5 pollution load (kg/d):
 - 1.2 Purification efficiency
 - 1.2.1 Evaluation of outflow values

Evaluation of outflow values **BOD_5** (mg/l)

Location	Sample type	Number of tests that meet the limit-values	Min	Max		Mean
				Value	Phase	
Inflow	24h composite samples	--				
Outflow	24h composite samples					
Inflow	Random samples	--				
Outflow	Random samples					

Evaluation of outflow values **COD** (mg/l)

Location	Sample type	Number of tests that meet the limit-values	Min	Max		Mean
				Value	Phase	
Inflow	24h composite samples	--				
Outflow	24h composite samples					
Inflow	Random samples	--				
Outflow	Random samples					

¹ In case of more test cycles indicate for each cycle.

Evaluation of outflow values **TOC** (mg/l)

Location	Sample type	Number of tests that meet the limit-values	Min	Max		Mean
				Value	Phase	
Inflow	24h composite samples	--				
Outflow	24h composite samples					
Inflow	Random samples	--				
Outflow	Random samples					

Evaluation of outflow values **SRF** (mg/l)

Location	Sample type	Number of tests that meet the limit-values	Min	Max		Mean
				Value	Phase	
Inflow	24h composite samples	--				
Outflow	24h composite samples					
Inflow	Random samples	--				
Outflow	Random samples					

1.2.2 Purification efficiency (elimination efficiency)

Parameter	Sample type	Min	Max	Mean
BOD ₅	24h composite samples			
BOD ₅	Random samples			
COD	24h composite samples			
COD	Random samples			
TOC	24h composite samples			
TOC	Random samples			
SRF	24h composite samples			
SRF	Random samples			

1.3 Further parameters measured

1.3.1 Additional inflow and outflow parameters:

Parameter	Inflow	Outflow
pH		
Conductivity		
Temperature of liquid phases		

1.3.2 The following operating parameters are – when available - to be recorded during sampling:

Concentration of dissolved oxygen in the bioreactor	
Dry matter content in the bioreactor	
Temperature in the bioreactor	
Ambient temperature	

1.3.3 Further operating parameters according to the manufacturer's operating instructions

.....

1.4 Competent authority or Technical service:

Place, date: Signature:

Section IV

Type approvals numbering system

(Model)

1. System

The number shall consist of four sections separated by the '*' character.

Section 1: The small letter 'e' for EU or the letter 'R' followed by the distinguishing number of the State issuing the type-approval:

01 = Germany	19 = Romania
02 = France	20 = Poland
03 = Italy	21 = Portugal
04 = Netherlands	23 = Greece
05 = Sweden	24 = Ireland
06 = Belgium	25 = Croatia
07 = Hungary	26 = Slovenia
08 = Czech Republic	27 = Slovakia
09 = Spain	29 = Estonia
11 = United Kingdom	32 = Latvia
12 = Austria	34 = Bulgaria
13 = Luxembourg	36 = Lithuania
14 = Switzerland	49 = Cyprus
17 = Finland	50 = Malta
18 = Denmark	

Section 2: The indication of the requirement level. The requirements regarding purification efficiency are likely to be stepped up in the future. The different requirement levels are denoted by Roman numerals, starting at level I.

Section 3: A four-digit sequential number (with leading zeroes as applicable) to denote the base type-approval number. The sequence shall start from 0001.

Section 4: A two-digit sequential number (with leading zero if applicable) to denote the extension. The sequence shall start from 01 for each number.

2. Examples

a) Third type-approval (with as yet no extension) issued by the Netherlands corresponding to level I:

R 4*I*0003*00 or e 4*I*0003*00

b) Second extension to the fourth type-approval issued by Germany corresponding to level II:

R 1*II*0004*02 or e 1*II*0004*02

Section V
Summary of type-approvals for on-board sewage treatment plant types
(Model)

Seal of the competent authority

List No.:

Period from to

1	2	3	4	5	6	7
Make ⁽¹⁾	Manufacturer's designation ⁽¹⁾	Type approval number	Date of type-approval	Extension/ refusal/ withdrawal ⁽²⁾	Reason for extension/refusal/withdrawal	Date of extension/ refusal/ withdrawal ⁽²⁾

¹ According to the type-approval certificate

² Specify as appropriate

Section VI
Summary of on-board sewage treatment plants manufactured
(Model)

Seal of the competent authority

List No:

For the period from: to:

The following information is supplied relating to on-board sewage treatment plant types and type-approval numbers of on-board sewage treatment plants manufactured within the above period in accordance with the provisions of the European Standard laying down technical requirements for inland navigation vessels (ES-TRIN):

Make (manufacturer's company name):

Manufacturer's designation for the on-board sewage treatment plant type:
.....

Type approval number:

Date of first issue:

Date of first issue (in the case of extensions):

Serial number:	... 001	... 001	... 001
	... 002	... 002	... 002
	.	.	.
	.	.	.
	.	.	.
 m p q

Section VII
Data sheet for on-board sewage treatment plants with type-approval
(Model)

Seal of the competent authority

					On-board sewage treatment plant characteristics				Purification efficiency					
No	Date of type-approval	Type approval number	Make	On-board sewage treatment plant type	Daily vol. flow rate of sewage Q_d (m ³ /d)	Daily BOD_5 pollution load (kg/d)			BOD_5		COD		TOC	
									24 h composite sample	Random -sample	24 h composite sample	Ran-dom-sample	24 h composite sample	Ran-dom-sample

Section VIII
Test report for on-board sewage treatment plants
(Model)

Name of vessel: Unique European vessel identification number:

Installation test⁽¹⁾ Performance test⁽¹⁾ Special test⁽¹⁾

On-board sewage treatment plant manufacturer:
(Make/trademark/manufacturer's trade name)

Sewage treatment plant type:
(Manufacturer's designation)

Type approval No.: Year of construction of on-board sewage treatment plant:

Serial number: Site of installation:

A. Capacity of the tanks used by the on-board sewage treatment plant (incl. upstream wastewater)

Tank name	Location of the tank within the vessel	Capacity in m ³

B. Component testing

The following on-board sewage treatment plant parts and components were identified and checked for compliance with the manufacturer's guide to checking the components and parameters of the on-board treatment plant relevant to sewage treatment and/or the type-approval certificate.

Component	Identified component number	Conformity ⁽¹⁾		
		<input type="checkbox"/> Yes	<input type="checkbox"/> No	<input type="checkbox"/> n/a
		<input type="checkbox"/> Yes	<input type="checkbox"/> No	<input type="checkbox"/> n/a
		<input type="checkbox"/> Yes	<input type="checkbox"/> No	<input type="checkbox"/> n/a
		<input type="checkbox"/> Yes	<input type="checkbox"/> No	<input type="checkbox"/> n/a
		<input type="checkbox"/> Yes	<input type="checkbox"/> No	<input type="checkbox"/> n/a
		<input type="checkbox"/> Yes	<input type="checkbox"/> No	<input type="checkbox"/> n/a
		<input type="checkbox"/> Yes	<input type="checkbox"/> No	<input type="checkbox"/> n/a
		<input type="checkbox"/> Yes	<input type="checkbox"/> No	<input type="checkbox"/> n/a
		<input type="checkbox"/> Yes	<input type="checkbox"/> No	<input type="checkbox"/> n/a
		<input type="checkbox"/> Yes	<input type="checkbox"/> No	<input type="checkbox"/> n/a

C. Results of random sample measurement

Parameter	Value obtained	Conformity ⁽¹⁾	
		<input type="checkbox"/> Yes	<input type="checkbox"/> No
		<input type="checkbox"/> Yes	<input type="checkbox"/> No
		<input type="checkbox"/> Yes	<input type="checkbox"/> No

D. Comments

.....
.....
.....

Name of inspector:
Place and date:
Stamp/signature:

(1) Specify as appropriate.

Section IX

Test procedure

1. General

1.1 Basics

The test specification shall be used to verify the suitability of on-board sewage treatment plants on passenger vessels.

In this procedure, the process and treatment technology used shall be examined and approved by means of a test plant. Conformity of the test plant with the treatment plants in service later is assured by applying identical design and dimensioning criteria.

1.2. Responsibility and test location

The test plant for a range of on-board sewage treatment plant types shall be tested by a technical service. The test conditions at the test site are the responsibility of the technical service and must correspond to the conditions specified here.

1.3 Documents to be submitted

The test shall be carried out on the basis of the information document in accordance with Annex 7, Section II.

1.4 Plant dimensioning specifications

The on-board sewage treatment plants shall be dimensioned and designed such that the limit values specified in Article 18.01(2), Tables 1 and 2 in their outflow are not exceeded in the course of their operation.

2. Measures preparatory to testing

2.1 General

Prior to commencement of the test the manufacturer shall supply the technical service with structural and process specifications of the test plant, to include a complete set of drawings and supporting calculations in accordance with Annex 7, Section II, and shall provide full information on the on-board sewage treatment plant's requirements in terms of installation, operation and maintenance. The manufacturer shall supply the technical service with information on the mechanical, electrical and technical safety of the on-board sewage treatment plant to be tested.

2.2 Installation and putting into service

For the purpose of the test, the manufacturer shall install the test plant in such a way as to correspond to the intended installation conditions on board passenger vessels. Prior to testing the manufacturer must assemble the on-board sewage treatment plant and put it into service. Start-up must be in accordance with the manufacturer's operating instructions and shall be checked by the technical service.

2.3 Run-in phase

The manufacturer shall notify the technical service of the nominal duration of the run-in phase up to normal operation in weeks. The manufacturer shall specify the point where the run-in phase is deemed to be complete and testing may commence.

2.4 Inflow characteristics

Domestic raw sewage shall be used for testing the test plant. The inflow characteristics as regards pollutant concentrations shall be obtained from the on-board sewage treatment plant manufacturer's dimensioning documentation in accordance with Annex 7, Section II by forming the quotient for the flow rate of organic substances in the form of a BOD_5 load in kg/d and the design flow rate of sewage Q_d in m³/d. The inflow characteristics shall be set accordingly by the inspection body.

Formula 1 – Calculation of the inflow characteristics

$$C_{BOD_5,mean} = \frac{BOD_5 \left[\frac{kg}{d} \right]}{Q_d \left[\frac{m^3}{d} \right]}$$

Should the calculation performed in accordance with formula 1 result in an average BOD_5 concentration of less than $C_{BOD_5,mean} = 500 \text{ mg/l}$, a minimum mean BOD_5 concentration in the sewage inflow of 500 mg/l shall be observed.

The technical service must not break up the inflowing raw sewage in a comminatory. Removal of sand (e.g. by screening out) is permissible.

3. Test procedure

3.1 Loading phases and hydraulic feeding

The test period shall comprise 30 test days. The test plant shall be fed on the test field with domestic waste water in accordance with the loading specified in Table 1. Various loading phases shall be covered, with the test sequence taking account of normal loading phases and special loading phases such as overload, underload and stand-by operation. The duration of each loading phase (number of test days) is set out in Table 1. The mean daily hydraulic load for each loading phase shall be set in accordance with Table 1. The mean pollutant concentration, to be set in accordance with (2.4), shall be kept constant.

Table 1: Load settings for each loading phase

Phase	Number of test days	Daily hydraulic load	Pollutant concentration
Normal load	20 days	Q_d	C_{BOD_5} in accordance with 2.4
Overload	3 days	$1,25 Q_d$	C_{BOD_5} in accordance with 2.4
Underload	3 days	$0,5 Q_d$	C_{BOD_5} in accordance with 2.4
Stand-by	4 days	Day 1 and day 2: $Q_d = 0$ Day 3 and 4 : Q_d	C_{BOD_5} in accordance with 2.4

The special load phases overload, underload and stand-by operation shall be carried out consecutively without interruption; the normal load phase shall be divided into several part phases. The test shall start and end with a normal load phase, of at least five days' duration in each case.

Daily hydraulic feeding hydrographs shall be set, depending on the specified operation of the on-board sewage treatment plant. The daily hydraulic feeding hydrograph shall be selected in accordance with the plant operation concept for the on-board sewage treatment plant. A distinction shall be made according to whether the on-board treatment plant is to be operated with or without an upstream sewage storage tank. The feeding hydrographs (daily hydrographs) are shown in Figure 1 and Figure 2.

Throughout the entire test period the hourly inflow must remain constant. The mean hourly volumetric flow rate of sewage $Q_{h,mean}$ is equivalent to 1/24 of the daily hydraulic load according to Table 1. The inflow shall be measured continuously by the technical service. The daily hydrograph must keep within a $\pm 5\%$ tolerance.

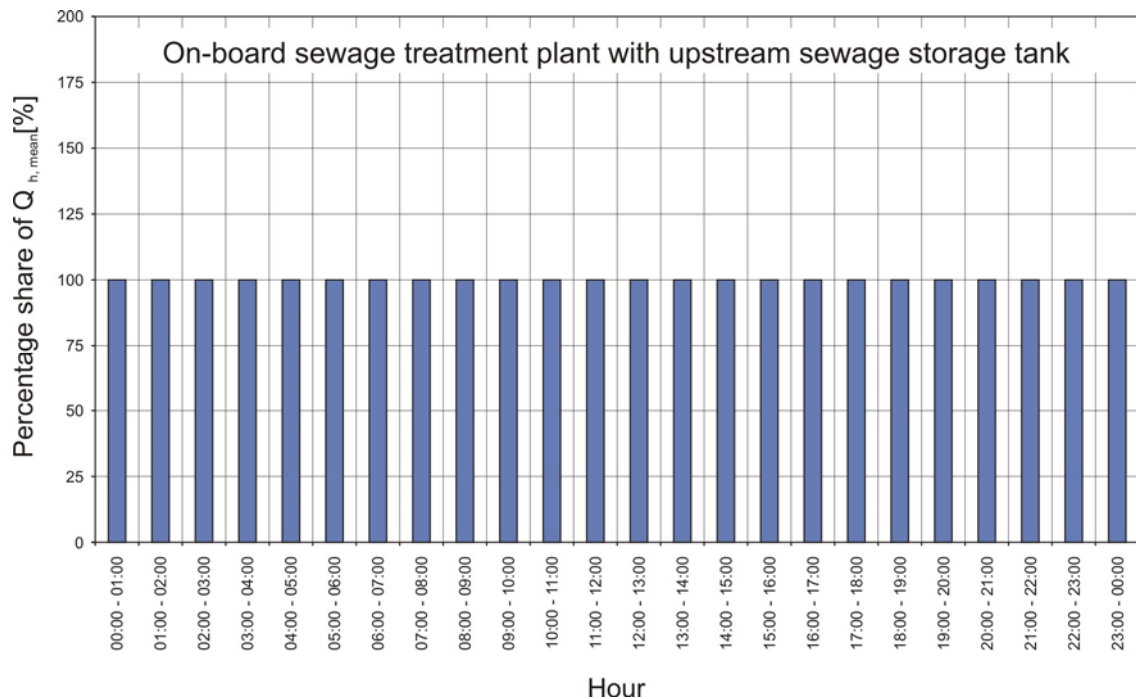

Figure 1: Daily hydrograph for feeding of on-board sewage treatment plant with upstream sewage storage tank

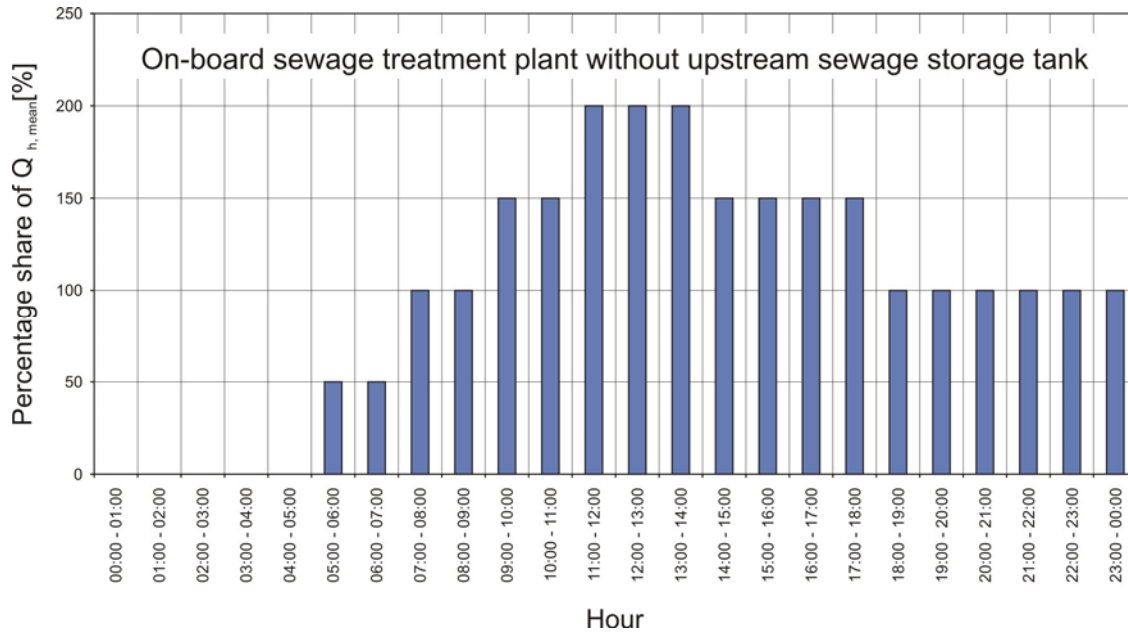

Figure 2: Daily hydrograph for feeding of on-board sewage treatment plant without upstream sewage storage tank

3.2 Interruption or cancellation of the test

It may be necessary to interrupt the test if the test plant can no longer be operated properly due to power failure or the malfunction of a subassembly. The test may be interrupted for the duration of the repair. In such cases it is not necessary to repeat the whole of the test, only the loading phase in which the subassembly malfunction took place.

After the test is interrupted for a second time, the technical service shall decide whether the test may be continued or must be cancelled. The grounds for the decision must be stated and documented in the test report. Should the test be cancelled it must be repeated in full.

3.3 Examinations of purification efficiency and compliance with outflow limit values

The technical service shall take samples from the inflow to the test plant and analyse them in order to confirm conformity with the inflow characteristics. Sewage samples shall be taken from the outflow of the test plant and analysed to determine the purification efficiency and compliance with the required outflow limit values. Sampling carried out shall include both simple random samples and 24h composite samples. In the case of the 24h composite samples, either time-proportional or flow-proportional sampling may be carried out. The type of 24h composite sample shall be specified by the inspection body. Sampling in the inflow and outflow shall be carried out simultaneously and to the same degree.

In addition to the control parameters BOD_5 , COD and TOC⁽¹⁾ the following parameters for inflow and outflow shall be measured in order to describe and represent the environmental and test conditions:

- a) solids removable by filtration (SRF);
- b) pH;
- c) conductivity;
- d) temperature of liquid phases.

The number of examinations varies according to the relevant loading phase and is set out in Table 2. The number of samplings relates to the inflow or outflow of the test plant.

Table 2: Specification of the number and timing of samplings in the inflow and outflow of the test plant

Loading phase	Number of test days	Number of samplings	Specification of timing of samplings
Normal load	20 days	24h composite samples: 8 Random samples: 8	Sampling at regular intervals throughout the period
Overload	3 days	24h composite samples: 2 Random samples: 2	Sampling at regular intervals throughout the period
Underload	3 days	24h composite samples: 2 Random samples: 2	Sampling at regular intervals throughout the period
Stand-by	4 days	24h composite samples: 2 Random samples: 2	24h composite sample: Sampling after inflow switched on and 24h later. Random sample: 1 hour after inflow switched on and 24h later.
Total number of 24h composite samples: 14			
Total number of random samples: 14			

Where applicable, the following operating parameters shall also be measured from the random samples taken:

- a) concentration of dissolved oxygen in the bioreactor;
- b) dry matter content in the bioreactor;
- c) temperature in the bioreactor;
- d) ambient temperature;
- e) other operating parameters in accordance with the manufacturer's operating instructions.

⁽¹⁾ The TOC will be monitored as of stage II of the maximum values in table 2 in Article 18.01(2).

3.4 Evaluation of examinations

In order to document the determined purification efficiency and to check adherence to process limit values, the minimum sample value (Min), the maximum sample value (Max) and the arithmetical mean (Mean) shall be specified as well as the individual measurement results for control parameters BOD_5 , COD and TOC.

The loading phase shall also be given for the maximum sample value. Evaluations shall be carried out for all loading phases jointly. The results shall be processed as shown in the following table:

Table 3a: Specification for the statistical processing of data gathered – evaluation to document compliance with outflow limit values

Parameter	Sampling type	Number of test that meet the limitvalues	Mean	Min	Max	
					Value	Phase
Inflow BOD_5	24h composite samples	--				
Outflow BOD_5	24h composite samples					
Inflow BOD_5	random samples	--				
Outflow BOD_5	random samples					
Inflow COD	24h composite samples	--				
Outflow COD	24h composite samples					
Inflow COD	random samples	--				
Outflow COD	random samples					
Inflow TOC	24h composite samples	--				
Outflow TOC	24h composite samples					
Inflow TOC	random samples	--				
Outflow TOC	random samples					
Inflow SRF	24h composite samples	--				
Outflow SRF	24h composite samples					
Inflow SRF	random samples	--				
Outflow SRF	random samples					

Table 3b: Specification for the statistical processing of data gathered – evaluation to document purification efficiency

Parameter	Sampling type	Mean	Min	Max
Elimination efficiency BOD_5	24h composite samples			
Elimination efficiency BOD_5	Random samples			
Elimination efficiency COD	24h composite samples			
Elimination efficiency COD	Random samples			
Elimination efficiency TOC	24h composite samples			
Elimination efficiency TOC	Random samples			
Elimination efficiency SRF	24h composite samples			
Elimination efficiency SRF	Random samples			

The remaining parameters in accordance with 3.3(b) to (d) and the operating parameters in accordance with 3.3 shall be summarised in a table specifying the minimum sample result (Min), the maximum sample result (Max) and the arithmetical mean (Mean).

3.5 Compliance with the requirements of Chapter 18

The limit values in accordance with Article 18.01(2) Tables 1 and 2 shall be deemed to be upheld, when each value for the parameters COD, BOD_5 and TOC:

- a) the mean values of the total of 14 outflow samples, and
- b) at least 10 of the total of 14 outflow samples do not exceed the specified limit values for 24h composite samples and random samples.

3.6 Operation and maintenance during testing

Throughout the testing the test plant shall be operated in accordance with the manufacturer's specifications. Routine checks and maintenance work shall be carried out in compliance with the manufacturer's operation and maintenance instructions. The excess sludge generated by the biological purification process may only be removed from the on-board sewage treatment plant if this is specified by the manufacturer in their operation and maintenance instructions. All maintenance work carried out shall be recorded by the technical service and documented in the test report. During the test no unauthorised persons may have access to the test plant.

3.7 Sample analysis / analysis method

The parameters to be studied shall be analysed using approved standard procedures. The standard procedure applied shall be specified.

4 Test report

4.1 The technical service is required to compile a report on the type test carried out. The report shall include at least the following information:

- a) details on the plant tested, such as its type, information on the nominal daily pollutant load and the dimensioning principles applied by the manufacturer;
- b) information on the conformity of the on-board sewage treatment plant tested with the documentation provided before the testing;
- c) information on individual measurement results, as well as on the evaluation of the plant's purification efficiency and compliance with the required outflow limit values;
- d) details on the removal of excess sludge, such as the size of the volumes removed and the frequency of removal;
- e) information on all operation, maintenance and repair work carried out during testing;
- f) information on any deterioration in the quality of the on-board sewage treatment plant occurring during testing as well as any interruptions of testing;
- g) information on any problems arising during testing;
- h) a list of responsible persons involved in the type testing of the on-board sewage treatment plant, giving their names and job titles;
- i) name and address of the laboratory which carried out the analysis of the waste water samples;
- j) analysis methods applied.

Appendix 1 Examples of test sequences

Example 1

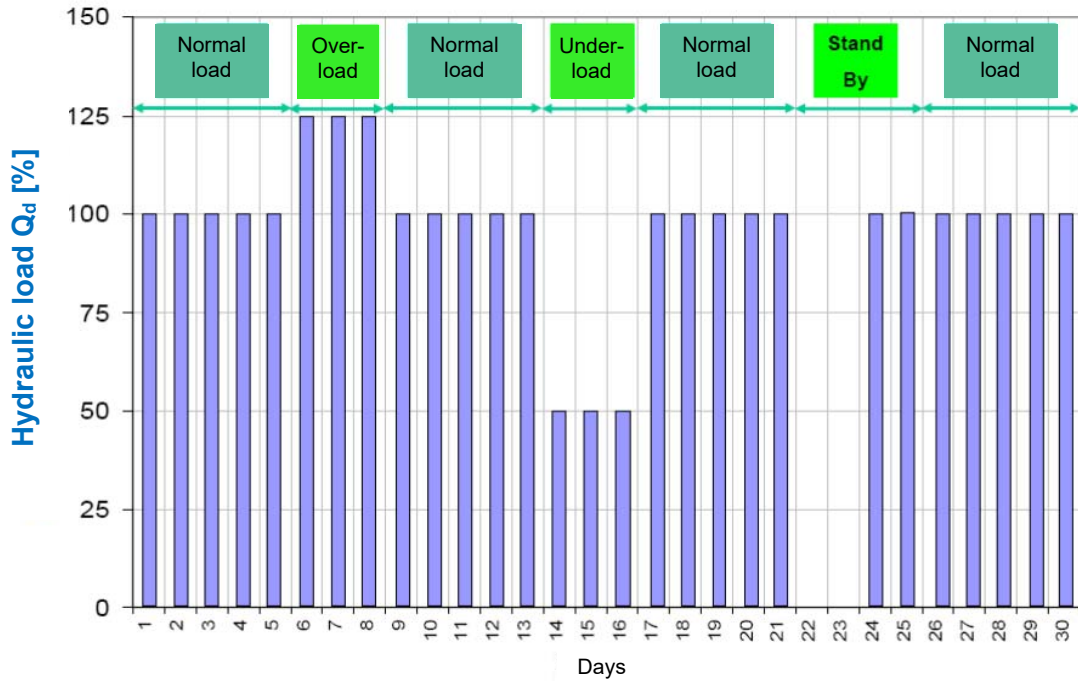

Example 2

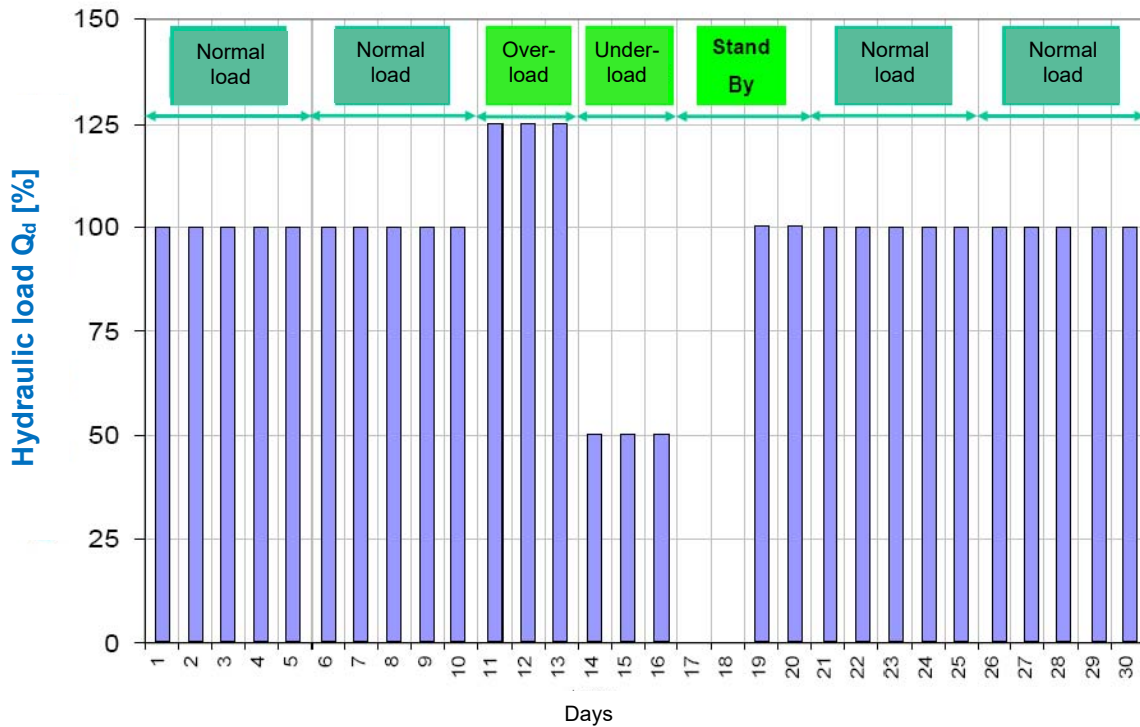

Appendix 2
Notes on determining biochemical oxygen demand after five days (BOD_5) in 24h composite samples

The International Standards ISO 5815 : 2019 and 5815-2 : 2003 stipulate that in order to carry out the analysis to determine biochemical oxygen demand after five days water samples should be stored immediately after sampling and up to the time of analysis in a brim-full, tightly sealed bottle at a temperature of 0–4 °C. The process of determining BOD_5 should be initiated as soon as possible or at least within twenty-four hours of completion of sampling.

In order to prevent biochemical degradation processes starting in the 24h composite sample, in practice the water sample is cooled to a maximum of 4 °C while sampling continues, and is stored at this temperature once the sampling process is complete.

Suitable sampling equipment is commercially available.

ANNEX 8
SUPPLEMENTARY PROVISIONS APPLICABLE TO CRAFT EQUIPPED WITH
PROPULSION OR AUXILIARY SYSTEM OPERATING
ON FUELS WITH A FLASHPOINT EQUAL TO OR LOWER THAN 55 °C

Contents

Section I Definitions

Section II Fuel storage

Chapter 1 LNG

Chapter 2 Methanol

Chapter 3 Hydrogen

Section III Energy converters

Chapter 1 Propulsion and auxiliary systems with fuel cells

Chapter 2 Propulsion and auxiliary systems with internal combustion engines using LNG as primary fuel

Chapter 3 Propulsion and auxiliary systems with internal combustion engines using methanol as fuel

Chapter 4 Propulsion and auxiliary systems with internal combustion engines using hydrogen as fuel

Section I

Definitions

For the purposes of this Annex, the following definitions shall apply:

1.1 General

- 1.1.1 *Enclosed room*: any room within which, in the absence of forced ventilation, the ventilation will be limited, and any explosive atmosphere will not be dispersed naturally.
- 1.1.2 *Semi-enclosed room*: a room limited by decks or bulkheads in such a manner that the natural conditions of ventilation are notably different from those obtained on open deck.
- 1.1.3 *Pressure Relief Valve (PRV)*: a spring-loaded device which is activated automatically by pressure, the purpose of which is to protect the tank or piping against unacceptable excess internal pressure.
- 1.1.4 *Pressure Vacuum (P/V) valve*: a valve or set of valves which keeps the tank overpressure or underpressure within tank design limits.
- 1.1.5 *Thermally activated pressure relief device (TPRD)*: a device which is activated automatically by temperature, the purpose of which is to protect the tank or piping against unacceptable excess internal pressure.
- 1.1.6 *Controlled tank venting system*: a system fitted with P/V valves to relieve overpressure and underpressure.
- 1.1.7 *ESD*: emergency shutdown, the immediate stopping of the energy converter and of all its processes as a reaction of the control system to deviations of the process parameters in order to avoid damage to the components and craft as well as hazards to people.
- 1.1.8 *Master fuel valve*: an automatic shut-off valve in fuel supply lines to engines (respectively fuel cells space).
- 1.1.9 *Double block and bleed valve*: a set of two automated valves in series in a pipe and a third valve enabling the pressure release from the pipe between those two valves leading to a safe location. The arrangement may also consist of a two-way valve and a closing valve instead of three separate valves.
- 1.1.10 *Air lock*: a space enclosed by gastight steel bulkheads with two gastight doors, intended to separate a non-hazardous area from a hazardous area.
- 1.1.11 *Double wall piping*: piping with a double wall design for which the space between the walls is pressurised with inert gas and equipped to detect any leakage of one of the two walls.
- 1.1.12 *Maximum working pressure*: the maximum pressure that is acceptable in a fuel tank or piping during operation. This pressure equals the opening pressure of pressure relief valves or devices.

- 1.1.13 *Design pressure*: the pressure on the basis of which the fuel tank or piping has been designed and built.
- 1.1.14 *Ventilated ducting*: a gas pipe installed in a pipe or duct equipped with mechanical exhaust ventilation.
- 1.1.15 *Gas warning equipment*: warning equipment to protect people and property from hazardous gases and gas-air mixtures. It consists of gas detectors to identify gases, a control unit for processing the signals and a display/alarm unit for displaying the status and warning.
- 1.1.16 *Secondary barrier*: the enclosure surrounding of the elements containing fuel (or the fuel cell components), designed to prevent fuel from escaping into the surrounding areas in the case of a leaking component (primary barrier).
- 1.1.17 *Lowest possible waterline*: the waterline corresponding to the displacement of the craft without ballast and without load.
- 1.1.18 *Dual-fuel engine*: an engine that is designed to simultaneously operate on two fuels, both fuels being metered separately, the consumed amount of one of the fuels relative to the other one being able to vary depending on the operation.
- 1.1.19 *Swappable tank*: a container or rack with one or several tanks, intended for temporary storage of fuel on board, supplying fuel for the propulsion or auxiliary systems of the craft and designed for being moved outboard.

2. Liquefied natural gas (LNG)

- 1.2.1 *Liquefied natural gas (LNG)*: natural gas that has been liquefied by cooling it to a temperature of - 161 °C.
- 1.2.2 *LNG system*: all components of the craft that may contain liquefied natural gas (LNG) or Natural Gas, such as engines, fuel tanks and bunkering piping.
- 1.2.3 *LNG bunkering system*: the arrangement for the bunkering of liquefied natural gas (LNG) on board (bunkering station and bunkering piping).
- 1.2.4 *Bunkering station*: the area on board where all equipment used for bunkering is located, such as manifolds, valves, survey instruments, safety equipment, monitoring station, tools, etc.
- 1.2.5 *LNG containment system*: the arrangement for the storage of liquefied natural gas (LNG) including tank connections.
- 1.2.6 *Gas supply system*: the arrangement, including the gas preparation system, gas supply lines and valves, to supply gas on board to all gas consuming equipment.
- 1.2.7 *Gas preparation system*: the unit used to convert liquefied natural gas (LNG) into Natural Gas, its accessories and its piping.

1.2.8 *System components:* all components of the installation that may contain liquefied natural gas (LNG) or Natural Gas (NG) (fuel tanks, pipelines, valves, hoses, pistons, pumps, filters, instrumentation, etc.).

3. Fuel cells

1.3.1 *Fuel cell system:* the system comprising the fuel cell components as well as other components and systems required to operate the fuel cells and to supply electrical power to the craft. This excludes the bunkering, storage and fuel supply systems.

1.3.2 *Fuel cell components:* all components of a fuel cell system which may contain fuel or hazardous vapours.

1.3.3 *Fuel cell space:* any enclosed space or enclosure containing a part or all fuel cell components.

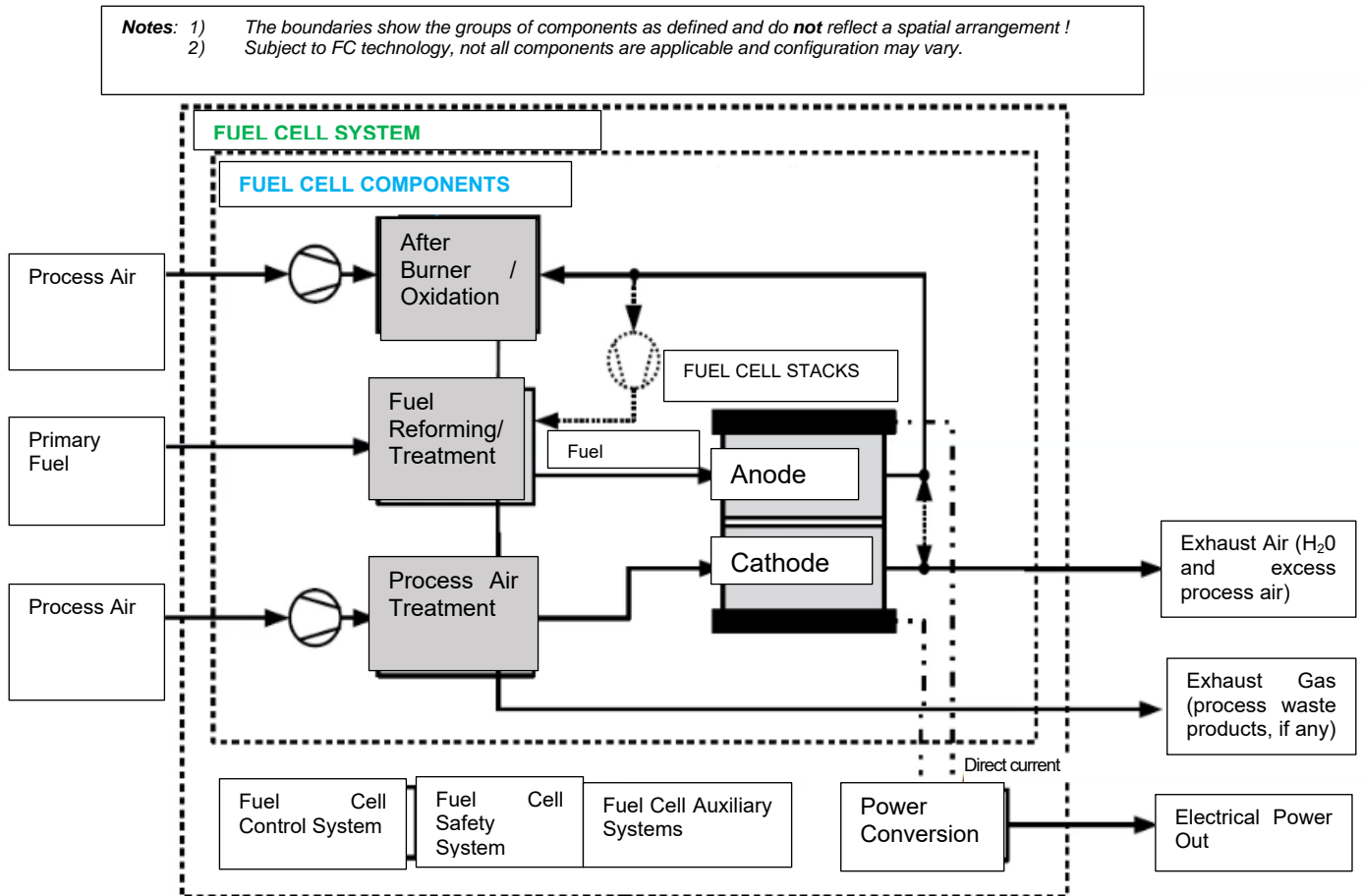

- 1.3.4 *Fuel cell*: an energy converter in which, by oxidation, the chemical energy of the fuel is directly converted to electrical and thermal energy.
- 1.3.5 *Reformer*: a device to convert gaseous or liquid primary fuels to reformat that can be used in fuel cells.
- 1.3.6 *Primary fuel*: fuel supplied to a fuel cell system.
- 1.3.7 *Fuel*: primary fuel or reformat with which the fuel cell is fed to convert energy.
- 1.3.8 *Reformat*: a hydrogen-containing gas generated in the reformer from primary fuel.
- 1.3.9 *Buffer vessel*: a device forming part of the fuel cell system to temporarily hold fuel in order to secure the stable operation of the fuel cell system, in particular to balance the flow of fuel to a fuel cell.

Section II *Fuel storage*

Chapter 1 LNG

2.1.1 LNG containment system

- 2.1.1.1 The LNG containment system shall be separated from engine rooms or other high fire risk areas.
- 2.1.1.2 LNG fuel tanks shall be located as close as possible to the longitudinal centreline of the craft.
- 2.1.1.3 The distance between the ship's hull of the craft and the LNG fuel tank shall not be less than 1,00 m. If LNG fuel tanks are located:
- below deck, the craft shall have a double side and a double bottom at the location of the LNG fuel tanks. The width of the double sides and the height of the double bottom shall not be less than 0,60 m.
 - on open deck, the distance shall be at least B/5 from the vertical planes defined by the craft's sides.
- 2.1.1.4 The LNG fuel tank shall be an independent tank designed in accordance with the European Standards EN 13530-1 : 2002, EN 13530-2/AC : 2006, ISO 20421-1 : 2019, EN 13458-2 : 2002 in combination with dynamic loads, or the IGC-Code (type C tank). The inspection body can accept other equivalent standards of one of the Member States.
- 2.1.1.5 Tank connections shall be mounted above the highest liquid level in the tanks. The inspection body can accept connections below the highest liquid level.
- 2.1.1.6 If tank connections are below the highest liquid level of the LNG fuel tanks, drip trays shall be placed below the tanks that meet the following requirements:
- the capacity of the drip tray shall be sufficient to contain the volume which could escape in the event of a pipe connection failure;
 - the material of the drip tray shall be suitable stainless steel; and
 - the drip tray shall be sufficiently separated or insulated from the hull or deck structures, so that the hull or deck structures are not exposed to unacceptable cooling in case of leakage of LNG.
- 2.1.1.7 The LNG containment system shall be provided with a secondary barrier. No secondary barrier is required for the LNG containment systems where the probability for structural failures and leakages through the primary barrier is extremely low and can be neglected.

- 2.1.1.8 If the secondary barrier of the LNG containment system is part of the hull structure it may be a boundary of the tank room subject to necessary precautions against leakage of cryogenic liquid.
- 2.1.1.9 The location and construction of the LNG containment system and the other equipment on open deck shall assure sufficient ventilation. Accumulation of escaped NG shall be prevented.
- 2.1.1.10 If condensation and icing due to cold surfaces of LNG fuel tanks lead to safety or functional problems, appropriate preventive or remedial measures shall be taken.
- 2.1.1.11 Each LNG fuel tank is to be fitted with at least two pressure relief valves that can prevent an overpressure if one of the valves is closed off due to malfunctioning, leakage or maintenance.
- 2.1.1.12 If fuel release into the vacuum space of a vacuum insulated LNG fuel tank cannot be excluded, the vacuum space shall be protected by a suitable pressure relief valve. If LNG fuel tanks are located in enclosed or semi enclosed rooms, the pressure relief device shall be connected to a venting system.
- 2.1.1.13 The exhaust outlets of the pressure relief valves shall be located not less than 2,00 m above the deck at a distance of not less than 6,00 m from the accommodation, passenger areas and work stations, which are located outside the hold or the cargo area. This height may be reduced when within a radius of 1,00 m round the pressure relief valves outlet there is no equipment, no work is being carried out, signs indicate the area and appropriate measures to protect the deck are being taken.
- 2.1.1.14 It shall be possible to safely empty the LNG fuel tanks, even if the LNG system is shut down.
- 2.1.1.15 It shall be possible to purge gas and vent LNG fuel tanks including gas piping systems. It shall be possible to perform inerting with an inert gas (e.g. nitrogen or argon) prior to venting with dry air, to exclude an explosion hazardous atmosphere in LNG fuel tanks and gas piping.
- 2.1.1.16 LNG fuel tanks' pressure and temperature shall be maintained at all times within their design limits.
- 2.1.1.17 If the LNG system is switched off, the pressure in the LNG fuel tank, shall be maintained below the maximum working pressure of the LNG fuel tank for a period of 15 days. It shall be assumed that LNG fuel tank was filled at filling limits according to 2.1.8 and that the craft remains in idle condition.
- 2.1.1.18 LNG fuel tanks shall be electrically bonded to the craft's structure.

2.1.2 LNG and NG piping systems

- 2.1.2.1 LNG and NG piping through other engine rooms or non-hazardous enclosed areas of the craft shall be enclosed in double wall piping or ventilated ducting.
- 2.1.2.2 LNG and NG piping shall not be located less than
- a) 1,00 m from the craft's side, and
 - b) 0,60 m from the bottom.
- 2.1.2.3 All piping and all components which can be isolated with valves from the LNG system in a liquid full condition shall be provided with pressure relief valves.
- 2.1.2.4 Piping shall be electrically bonded to the craft's structure.
- 2.1.2.5 Low temperature piping shall be thermally isolated from the adjacent hull structure, where necessary. Protection against accidental contact shall be provided.
- 2.1.2.6 The design pressure of piping shall not be less than 150 % of the maximum working pressure. The maximum working pressure of piping inside rooms shall not exceed 1000 kPa. The design pressure of the outer pipe or duct of gas piping systems shall not be less than the design pressure of the inner gas pipe.
- 2.1.2.7 Gas piping in ESD protected engine rooms shall be located as far away as practicable from the electrical installations and tanks containing flammable liquids.

2.1.3 Drainage systems

- 2.1.3.1 Drainage systems for areas where LNG or NG can be present shall:
- a) be independent and separate from the drainage system of areas where LNG and NG cannot be present, and
 - b) not lead to pumps in non-hazardous areas.
- 2.1.3.2 Where the LNG containment system does not require a secondary barrier, suitable drainage arrangements for the tank rooms that are not connected to the engine rooms shall be provided. Means of detecting any LNG leakage shall be provided.
- 2.1.3.3 Where the LNG containment system requires a secondary barrier, suitable drainage arrangements for dealing with any leakage of LNG into the inter-barrier spaces shall be provided. Means of detecting such a leakage shall be provided.

2.1.4 Drip trays

- 2.1.4.1 Suitable drip trays shall be fitted where leakage can cause damage to the craft's structure or where limitation of the area which is affected from a spill is necessary.

2.1.5 Arrangement of entrances and other openings

- 2.1.5.1 Entrances and other openings from a non-hazardous area to a hazardous area shall only be permitted to the extent necessary for operational reasons.
- 2.1.5.2 For entrances and openings to a non-hazardous area within 6,00 m from the LNG containment system, the gas preparation system or the outlet of a pressure relief valve, a suitable airlock shall be provided.
- 2.1.5.3 Air locks shall be mechanically ventilated at an overpressure relative to the adjacent hazardous area. Doors shall be of self-closing type and shall not be fitted with holding back arrangements.
- 2.1.5.4 Air locks shall be designed in a way that no gas can be released to non-hazardous areas in case of the most critical events in the hazardous spaces separated by the air lock. The events shall be evaluated in the risk assessment according to Article 30.04.
- 2.1.5.5 Air locks shall be free of obstacles, shall provide easy passage and shall not be used for other purposes.
- 2.1.5.6 An optical and acoustic alarm shall be given on both sides of the air lock, if more than one door is not closed or if gas is detected in the air lock.

2.1.6 Ventilation systems

- 2.1.6.1 The ventilators used for ventilation of hazardous spaces shall be of a certified safe type.
- 2.1.6.2 Electric motor driving ventilators shall comply with the required explosion protection in the area where it is installed.
- 2.1.6.3 An optical and acoustic alarm shall be triggered in the wheelhouse or at any other permanently manned location in the event of any loss of the required ventilating capacity.
- 2.1.6.4 Any ducting used for the ventilation of hazardous spaces shall be separate from that used for the ventilation of non-hazardous spaces.
- 2.1.6.5 Ventilation systems required to avoid any explosive atmosphere shall have at least two ventilators with independent power supply, each of sufficient capacity.
- 2.1.6.6 Air for ventilation of hazardous spaces shall be taken from non-hazardous areas.
- 2.1.6.7 Air for ventilation of non-hazardous spaces shall be taken from non-hazardous areas which are located at least 1,50 m from the boundaries of any hazardous area.

2.1.6.8 Where the inlet duct passes through a hazardous space, the duct shall have overpressure relative to this space. Overpressure shall not be required if it is ensured that gases cannot leak into the duct.

Where the outlet duct from a hazardous space passes through a non-hazardous room, the duct shall have underpressure relative to this space. Underpressure shall not be required when structural measures on the duct ensure that gases cannot leak into the room.

2.1.6.9 Air outlets from hazardous spaces shall be located in an open area which has the same or less hazard than the ventilated space.

2.1.6.10 Air outlets from non-hazardous spaces shall be located outside any hazardous space.

2.1.6.11 In enclosed rooms the ventilation exhaust ducts shall be located at the top of these rooms. Air inlets shall be located at the bottom.

2.1.7 LNG bunkering system

2.1.7.1 The LNG bunkering system shall be arranged in such a way that

- a) no gas is discharged into the atmosphere during filling of LNG fuel tanks, and
- b) the quantity of gas discharged while connecting, disconnecting or purging of hoses is minimised.

2.1.7.2 Bunkering stations and all valves used for bunkering shall be located on the open deck so that sufficient natural ventilation is provided.

2.1.7.3 Bunkering stations shall be so positioned and arranged in such a way that any damage to the gas piping does not cause damage to the craft's LNG containment system.

2.1.7.4 Suitable means shall be provided to relieve the pressure and remove liquid contents from pump suctions and bunker piping.

2.1.7.5 Hoses used for the bunkering of LNG shall be:

- a) compatible with LNG, in particular suitable for the LNG temperature, and
- b) designed for a bursting pressure not less than five times the maximum pressure they can be subjected to during bunkering.

2.1.7.6 The bunkering manifold shall be designed to withstand normal mechanical loads during bunkering. The connections shall be of dry-disconnect type and equipped with appropriate additional safety dry break-away couplings.

2.1.7.7 It shall be possible to operate the master LNG bunkering valve during bunkering operations from a safe control station on the craft.

2.1.7.8 Bunkering piping shall be arranged for inerting and gas freeing.

2.1.7.9 All the components of the bunkering system shall be in accordance with European Standard EN 20519 : 2022 (5.3 to 5.7).

2.1.8 Filling limits of LNG fuel tanks

2.1.8.1 The level of LNG in the LNG fuel tank shall not exceed the filling limit of 95 % full at the reference temperature. The reference temperature means the temperature corresponding to the vapour pressure of the fuel at the opening pressure of the pressure relief valves.

2.1.8.2 A filling limit curve for LNG filling temperatures shall be prepared from the following formula:

$$LL = FL \cdot \rho_R / \rho_L$$

where:

LL = loading limit, maximum allowable liquid volume relative to the LNG fuel tank volume to which the tank may be loaded, expressed in per cent,

FL = filling limit expressed in per cent, here 95 %,

ρ_R = relative density of fuel at the reference temperature,

ρ_L = relative density of fuel at the loading temperature.

2.1.8.3 For craft exposed to significant wave heights or significant motion on account of operations, the filling limit curve shall be adapted accordingly, based on the risk assessment, according to Article 30.04.

2.1.9 Gas supply system

2.1.9.1 The gas supply system shall be so arranged that the consequences of any release of gas will be minimised, while providing safe access for operation and inspection.

2.1.9.2 The parts of the gas supply systems which are located outside the engine room or the fuel cell space shall be designed in a way that a failure of one barrier cannot lead to a leak from the system into the surrounding area causing immediate danger to the people on board, the environment or the craft.

2.1.9.3 LNG fuel tank inlets and outlets shall be provided with valves located as close to the tank as possible.

2.1.9.4 The gas supply system to each engine or several engines shall be equipped with a master fuel valve. The valves shall be situated as close as practicable to the gas preparation system but, in any case, outside the engine room.

The gas supply system to each fuel cell space or several fuel cell spaces shall be equipped with a master fuel valve to shut-off fuel supply lines to consumers. The valves shall be situated as close as practicable to the gas preparation system but, in any case, outside the fuel cell space.

- 2.1.9.5 In the case of a propulsion or auxiliary system with an internal combustion engine, the master fuel valve shall be operable:
- within and outside the engine room, and
 - from the wheelhouse.
- 2.1.9.6 In the case of a propulsion or auxiliary system with fuel cells, by analogy with Article 8.05(7), the master fuel valve shall be operable:
- from the outside in the direct vicinity of the fuel cell space,
 - from the inside in case of fuel cell space referred to in (3.1.1.14.5), and
 - from the wheelhouse.
- 2.1.9.7 Any gas consuming equipment shall be provided with a set of double block and bleed valves to assure safe isolation of the fuel supply system. The two block valves shall be of the fail-to-close type, while the ventilation valve shall be of the fail-to-open type.
- 2.1.9.8 For multi-engine installations, where a separate master fuel valve is provided for each engine and for one-engine installations, the master fuel valve and the double block and bleed valve functions can be combined.

For installations with several fuel spaces, where a separate master fuel valve is provided for each fuel space and for a single fuel cell, the master fuel valve and the double block and bleed valve functions can be combined.

One shutdown valve of the double block and bleed valves shall also be manually operated.

2.1.10 Gas supply shut down

- 2.1.10.1 If the fuel supply is not changed over to gasoil before stopping, the gas supply system from the master fuel valve to the engine and the exhaust system shall be purged in order to discharge any residual gas which may be present.
- 2.1.10.2 In case of an emergency stop or a normal stop, the supply of gas shall be automatically shut off not later than
- the supply of the other fuel for dual fuel engines. It shall not be possible to shut off the other fuel without first or simultaneously closing the gas supply to the respective cylinders or to the complete engine.
 - the ignition source for single fuel engines. It shall not be possible to shut off the ignition source without first or simultaneously closing the gas supply to the respective cylinders or to the complete engine.
- 2.1.10.3 In the case of a propulsion or auxiliary system with fuel cells, it shall not be possible to shut off the fuel cell system without first or simultaneously closing the gas supply.

2.1.11 Fire Safety

2.1.11.1 General

2.1.11.1.1 In addition to Article 30.08, the provisions of (2.1.11) apply.

2.1.11.1.2 A room or enclosure containing the gas preparation system or parts thereof shall be regarded as engine room for fire protection purposes.

2.1.11.2 Fire alarm system

2.1.11.2.1 Smoke detectors alone are not sufficient for rapid detection of a fire.

2.1.11.2.2 The fire alarm system shall have the means to identify each fire detector or manual call point individually.

2.1.11.2.3 The gas safety system shall shut down the relevant parts of the gas supply system automatically upon fire detection in rooms containing gas installations.

2.1.11.3 Fire protection

2.1.11.3.1 Accommodation, passenger areas, engine rooms and escape routes shall be shielded with Type A60 partitions, where the distance is less than 3,00 m to LNG fuel tanks and bunkering stations located on deck.

2.1.11.3.2 The boundaries of LNG fuel tank rooms and ventilation ducts to such rooms below the bulkhead deck shall comply with Type A60. However, where the room is adjacent to tanks, voids, auxiliary engine rooms of little or no fire risk, sanitary and similar spaces, the insulation may comply with Type A0.

2.1.11.4 Fire prevention and cooling

2.1.11.4.1 A water spray system shall be installed for cooling and fire prevention to cover exposed parts of LNG fuel tank(s) located on open deck.

2.1.11.4.2 If the water spray system is part of the firefighting systems mentioned in Articles 13.04 or 13.05, the required fire pump capacity and working pressure shall be sufficient to ensure the operation of both the required numbers of hydrants and hoses and the water spray system simultaneously. The connection between water spray system and the firefighting systems mentioned in Articles 13.04 or 13.05 shall be provided through a screw-down non-return valve.

2.1.11.4.3 If firefighting systems mentioned in Articles 13.04 or 13.05 are installed onboard a craft where the LNG fuel tank is located on open deck, isolating valves shall be fitted in the firefighting systems in order to isolate damaged sections of the firefighting systems. Isolation of a section of firefighting systems shall not deprive the fire line ahead of the isolated section of water.

2.1.11.4.4 The water spray system shall also provide coverage for boundaries of the superstructures, unless the tank is located 3,00 m or more from the boundaries.

2.1.11.4.5 The water spray system shall be designed to cover all areas as specified above with an application rate of 10 l/min/m² for horizontal projected surfaces and 4 l/min/m² for vertical surfaces.

2.1.11.4.6 The water spray system shall be capable of being put into operation from the wheelhouse and from the deck.

2.1.11.4.7 The nozzles shall be arranged to ensure an effective distribution of water throughout the area being protected.

2.1.11.5 Fire extinguishing

2.1.11.5.1 In addition to the requirements of Article 13.03, two additional portable dry powder fire extinguishers of at least 12 kg capacity shall be located near the bunkering station. They shall be suitable for Class C fires.

2.1.12 Submerged gas pump motors

2.1.12.1 Submerged gas pump motors and their supply cables may be fitted in LNG containment systems. Arrangements shall be made to alarm in low liquid level and automatically shut down the motors in the event of low-low liquid level. The automatic shutdown may be accomplished by sensing low pump discharge pressure, low motor current, or low liquid level. This shutdown shall give an optical and acoustic alarm in the wheelhouse. Gas pump motors shall be capable of being isolated from their electrical supply during gas-freeing operations.

2.1.13 Control, Monitoring and Safety Systems

2.1.13.1 General

2.1.13.1.1 In addition to Article 30.10, the provisions of (2.1.13) apply.

2.1.13.1.2 The gas supply system shall be fitted with its own gas control and gas monitoring system and its own gas safety system. All elements of these systems shall be capable of being functionally tested.

2.1.13.1.3 The gas safety system shall shut down the gas supply system automatically, upon failure in systems essential for the safety, and upon fault conditions which may develop too fast for manual intervention.

2.1.13.2 LNG bunkering system and LNG containment system monitoring

2.1.13.2.1 Each LNG fuel tank shall be fitted with:

- a) at least two liquid level indicators, which shall be arranged so that they can be maintained in an operational condition,
- b) a pressure indicator capable of indicating throughout the operating pressure range and which is clearly marked with the maximum working pressure of the LNG fuel tank,

- c) a high liquid level alarm operating independently of other liquid level indicators which shall give an optical and acoustic alarm when activated, and
- d) an additional sensor operating independently of the high liquid level alarm which shall automatically actuate the master LNG bunkering valve in a manner that will both avoid excessive liquid pressure in the bunkering piping and prevent the tank from becoming liquid full.

2.1.13.2.2 Each pump discharge line and each liquid and vapour gas shore connection shall be provided with at least one local pressure indicator. In the pump discharge line, the indicator shall be placed between the pump and the first valve. The permissible maximum pressure or vacuum value shall be indicated on each indicator.

2.1.13.2.3 A high-pressure alarm shall be provided at the LNG containment system and at the pump. Where vacuum protection is required, a low-pressure alarm shall be provided.

2.1.13.2.4 Control of the bunkering shall be possible from a safe control station remote from the bunkering station. At this control station the LNG fuel tank pressure and level shall be monitored. Overfill alarm, high and low-pressure alarm and automatic shutdown shall be indicated at this control station.

2.1.13.2.5 If the ventilation in the ducting enclosing the bunkering lines stops, an optical and acoustic alarm shall be actuated at the control station.

2.1.13.2.6 If gas is detected in the ducting enclosing the bunkering piping an optical and acoustic alarm and emergency shutdown shall be actuated at the control station.

2.1.13.2.7 Appropriate and sufficient suitable protective clothing and equipment for bunkering operations shall be available on board according to operating manual.

2.1.13.3 Gas warning equipment

2.1.13.3.1 Gas warning equipment shall be designed, installed and tested in accordance with a recognised Standard, such as European Standard EN 60079-29-1 : 2020.

2.1.13.3.2 Permanently installed gas detectors shall be provided for:

- a) tank connection areas including LNG fuel tanks, pipe connections and first valves,
- b) ducts around gas piping,
- c) engine rooms containing gas piping, gas equipment or gas consuming equipment,
- d) the room containing the gas preparation system,
- e) other enclosed rooms containing gas piping or other gas equipment without ducting,
- f) other enclosed or semi-enclosed rooms
 - aa) where gas vapours may accumulate including inter-barrier spaces and
 - bb) tank rooms of independent LNG fuel tanks other than type C,

- g) air locks, and
- h) air outlets of rooms in which gas vapours may accumulate.

2.1.13.3.3 By derogation to (2.1.13.3.2), permanently installed sensors which detect gas by difference of pressure can be used for inter-barrier spaces in double wall piping.

2.1.13.3.4 The number and redundancy of gas detectors in each room shall be considered taking size, layout and ventilation of the room into account.

2.1.13.3.5 Permanently installed gas detectors shall be located where gas may accumulate and in the ventilation outlets of these rooms.

2.1.13.3.6 An optical and acoustic alarm shall be activated before the gas concentration reaches 20 % of the lower explosive limit. The gas safety system shall be activated at 40 % of the lower explosive limit.

2.1.13.3.7 Optical and acoustic alarms from the gas warning equipment shall be actuated in the wheelhouse.

2.1.13.4 Safety functions of gas supply systems

2.1.13.4.1 If the gas supply system is shut off due to activation of an automatic valve, it shall not be restarted until the reason for the disconnection is ascertained and the necessary actions taken. Instructions to this effect shall be placed in a prominent position at the control station for the shut-off valves in the gas supply lines.

2.1.13.4.2 If the gas supply system is shut off due to a gas leak, it shall not be opened until the leak has been found and the necessary actions have been taken. Instructions to this effect shall be placed in a prominent position in the engine room.

2.1.13.4.3 The gas supply system shall be arranged for manual remote emergency stop from the following locations as applicable:

- a) wheelhouse,
- b) control station of the bunkering station, or
- c) any permanently manned location.

Chapter 2 Methanol

2.2.1 General

2.2.1.1 Equipment or piping containing liquid methanol fuel shall be arranged in enclosures, spaces or ducts providing a secondary barrier. This requirement applies notably to pump, filters and fittings.

No secondary barrier is required on open deck.

2.2.2 Methanol fuel tanks

2.2.2.1 Methanol fuel shall be stored in tanks which are

- a) either an integral part of the hull or which are firmly attached to the hull;
- b) made in way that they are able to withstand the mechanical, chemical and thermal stresses to which they are likely to be subjected.

Materials other than steel may be used for methanol fuel tanks (consisting of primary barrier and where applicable secondary barrier), provided that these materials have structural and integrity properties equivalent to steel, at the end of the applicable fire exposure according to the standard one-hour fire test. These requirements are deemed fulfilled when the materials used provide Type A60 partitions.

2.2.2.2 Methanol fuel tanks and their piping shall be designed to prevent electrostatic charges. Independent fuel tanks shall be electrically bonded to the craft's structure.

2.2.2.3 Methanol fuel tanks and their piping and other accessories shall be laid out and arranged in such a way that neither fuel nor fuel vapours may accidentally reach the inside of the craft.

2.2.2.4 No methanol fuel tanks may be located ahead of the collision bulkhead or aft of the aft-peak bulkhead.

2.2.2.5 Methanol fuel tanks and their fittings shall not be located directly above engines or exhaust pipes.

2.2.2.6 Directly at tank outlets, the pipework for the supply of fuels shall be fitted with a quick-closing valve that can be operated from the deck, even when the spaces in question are closed.

If the operating device is concealed, the lid or cover shall not be lockable.

The operating device shall be marked in red. If the device is concealed it shall be marked with a symbol for the "quick-closing valve on the tank" in accordance with Figure 9 of Annex 4 with a side length of at least 10 cm.

2.2.2.7 Methanol fuel tanks shall be safeguarded against fuel spills during bunkering by means of appropriate onboard technical devices which shall be entered in item 52 of the inland navigation vessel certificate. Derogation from this requirement is acceptable if fuel is taken on from bunkering stations with their own technical devices to prevent fuel spills on board during bunkering.

2.2.2.8 A fixed piping system shall be arranged to allow safe gas freeing of each fuel tank.

2.2.3 Inerted methanol fuel tanks

2.2.3.1 Inerted methanol fuel tanks shall be inerted at all times during normal operation.

2.2.3.2 The design of the inerted tank system shall eliminate the possibility of an explosive atmosphere in the fuel tank, during any part of the gas change, gas-freeing or inerting operation by using an inerting medium.

2.2.3.3 According to (2.2.1.1), if inerted methanol fuel tanks are located below deck, they shall be surrounded by a secondary barrier for leakage containment and detection. However, the secondary barrier can be omitted on those surfaces bound by

- a) shell plating,
- b) tank tops which are not under the static pressure of the liquid and facing open deck,
- c) tank tops which are not under the static pressure of the liquid and facing spaces permanently ventilated with at least 15 air changes per hour (e.g. engine rooms, pump rooms or similar), or
- d) other methanol fuel tanks or spaces with equipment containing methanol fuel.

2.2.3.4 For inerted methanol fuel tanks below deck,

- a) the distance between the craft's side (shell plating) and the secondary barrier of the tank shall be at least 0,60 m and
- b) the distance between the craft's bottom (shell plating) and the secondary barrier of the tank shall be at least 0,50 m.

For the case referred to in (2.2.3.3)(a), this means:

- a) the distance between the craft's side (shell plating) and the vertical part of the secondary barrier of the tank opposite to the craft's side, shall be at least 0,60 m.
- b) the distance between the craft's bottom (shell plating) and the horizontal part of the upper secondary barrier of the tank, opposite to the craft's bottom, shall be at least 0,50 m.

Because the boundaries of the spaces referred to in (2.2.3.3)(c) and (d) act as secondary barrier,

- a) the distance between the craft's side (shell plating) and the boundaries of these spaces shall be at least 0,60 m and
- b) the distance between the craft's bottom (shell plating) and the boundaries of these spaces shall be at least 0,50 m.

In accordance with the risk assessment referred to in Article 30.04, the inspection body might require greater values for the distances mentioned above.

- 2.2.3.5 For inerted methanol fuel tanks on open deck, the distance between the vertical planes defined by the craft's sides (shell plating) and the tank shall be at least 0,60 m.

2.2.4 Non-inerted methanol fuel tanks

- 2.2.4.1 In accordance with (2.2.1.1), if non-inerted methanol fuel tanks are located below deck, they shall be surrounded by a secondary barrier for leakage containment and detection. However, the secondary barrier can be omitted on those surfaces bound by

- a) shell plating below the lowest possible waterline, or
- b) other methanol fuel tanks or spaces with equipment containing methanol fuel.

- 2.2.4.2 For non-inerted methanol fuel tanks below deck,

- a) the distance between the craft's side (shell plating) and the secondary barrier of the tank shall be at least 0,60 m and
- b) the distance between the craft's bottom (shell plating) and the secondary barrier of the tank shall be at least 0,50 m.

For the case referred to in (2.2.4.1)(a), this means:

- a) the distance between the craft's side (shell plating) and the vertical part of the secondary barrier of the tank opposite to the craft's side, shall be at least 0,60 m.
- b) the distance between the craft's bottom (shell plating) and the horizontal part of the upper secondary barrier of the tank, opposite to the craft's bottom, shall be at least 0,50 m.
- c) the distance between the craft's side (shell plating) and the tank, above the lowest possible waterline, shall be at least 0,60 m.

Because the boundaries of the spaces referred to in (2.2.4.1)(b) act as secondary barrier,

- a) the distance between the craft's side (shell plating) and the boundaries of these spaces shall be at least 0,60 m and
- b) the distance between the craft's bottom (shell plating) and the boundaries of these spaces shall be at least 0,50 m.

In accordance with the risk assessment referred to in Article 30.04, the inspection body might require greater values for the distances mentioned above.

- 2.2.4.3 For non-inerted methanol fuel tanks on open deck, the distance between the vertical planes defined by the craft's sides (shell plating) and the tank shall be at least 0,60 m.

2.2.5 Tank venting systems

- 2.2.5.1 Tank venting systems for fuel vapours shall be designed and arranged in such a way that releases are safely led overboard and do not lead to an unsafe situation.

Vent lines shall be designed and arranged in such a way that neither fuel nor fuel vapours may accidentally reach the inside of the craft.

- 2.2.5.2 Design and arrangement of tank venting systems shall prevent flame propagation into the fuel containment system. Each tank shall be protected by a suitable flame arrestor. Where the venting lines cannot withstand the deflagration, pressure flame screens shall be fitted to the overboard outlet.
- 2.2.5.3 Tank venting systems shall be sized to permit bunkering at nominal loading rate without overpressurizing the fuel tanks.
- 2.2.5.4 The tank vent outlets shall be arranged in such a way that no water ingress is possible.
- 2.2.5.5 In the tank vent lines, no shut-off valves shall be installed. For tank segregation purposes during maintenance work, shut-off valves in common vent lines may be accepted if a secondary independent overpressure or underpressure protection is provided for all connected tanks.
- 2.2.5.6 If a controlled tank venting system is provided for the fuel tanks:
- Pressure Vacuum (P/V) valves (combined or separate valves) shall be fitted to each fuel tank. The controlled tank venting system may be designed with individual vent outlets from each fuel tank or with vent lines from each individual fuel tank connected to a common header; and
 - The controlled tank venting system shall be designed with redundancy for the relief of full flow overpressure and/or underpressure. As alternative to this redundancy, the inspection body may accept pressure sensors fitted in each fuel tank and connected to an alarm system.
- 2.2.5.7 The vent lines below deck shall be either:
- located at least 0,60 m from the craft's side (shell plating); or
 - surrounded by a secondary barrier. The distance between the craft's side (shell plating) and the vertical part of the secondary barrier of the vent line opposite to the craft's side shall be at least 0,60 m.

If vent lines pass through accommodations, only double wall piping is allowed.

2.2.6 Methanol fuel piping systems

- 2.2.6.1 Methanol fuel piping shall be electrically bonded to the craft's structure.
- 2.2.6.2 Methanol fuel piping and other accessories shall be laid out and arranged in such a way that neither fuel nor fuel vapours may accidentally reach the inside of the craft.

2.2.6.3 In accordance with (2.2.1.1), below deck, methanol fuel piping shall be surrounded by a secondary barrier for leakage containment and detection.

2.2.6.4 The horizontal distance between the secondary barrier of methanol fuel piping below deck and the craft's side (shell plating) shall be at least 0,60 m.

In accordance with the risk assessment referred to in Article 30.04, the inspection body might require greater values for the distance mentioned above.

2.2.6.5 The design pressure of the secondary barrier around a fuel pipe shall not be less than the maximum working pressure of the fuel pipe. As an alternative the secondary barrier around a fuel pipe shall be dimensioned in accordance with the calculated maximum built-up pressure in the case of a pipe rupture.

2.2.6.6 In accordance with (2.2.1.1), on open deck, a secondary barrier is not required, however:

- a) single walled methanol fuel piping shall be located as far away as practicable from the electrical installations, sources of ignition, and tanks containing flammable liquids;
- b) the number of connections of fuel pipes shall be kept to a minimum; and
- c) where necessary, connections of fuel pipes shall be screened or otherwise suitably protected to avoid fuel spray or leakages onto hot surfaces, into machinery air intakes, or other sources of ignition.

2.2.6.7 All pumps in the fuel system shall be protected against running dry (i.e. protected against operation in the absence of fuel or service fluid).

All pumps which are capable of developing a pressure exceeding the design pressure of the system shall be provided with pressure relief valves. Each pressure relief valve shall be in closed circuit, i.e. arranged to discharge back to the piping upstream of the suction side of the pump.

2.2.6.8 The design pressure for any section of the fuel piping system is the maximum gauge pressure to which the system may be subjected in service, taking into account the highest set pressure on any relief valve on the system.

2.2.6.9 For maintenance, it shall be possible that all sections of the fuel system can be safely

- a) isolated, and
- b) drained and purged of fuel.

2.2.7 Drainage systems and drip trays

2.2.7.1 Suitable drainage and purging arrangements shall be provided for dealing with any leakage of methanol fuel into the interbarrier spaces.

2.2.7.2 Drainage systems for areas where methanol fuel can be present shall be independent and separate from the drainage system of areas where methanol fuel cannot be present.

2.2.7.3 For the purpose of draining methanol leakages from interbarrier spaces, provisions shall be made such that the leakages can be drained into suitable mobile or fixed collecting tanks or be lead directly overboard below the lowest possible waterline.

2.2.7.4 Leakage on open deck from single walled tanks or fuel containing equipment shall be contained and drained by a dedicated drain discharging below the lowest possible waterline.

2.2.8 Arrangement of entrances and other openings

2.2.8.1 Access to a hazardous space shall not be possible before

- a) the fuel components and piping inside are safely shut down, and
- b) the inside atmosphere is confirmed gas-free by the means of sensors.

All controls and all parameters required for safe operation of the fuel system and gas freeing of the space shall be remotely operated and monitored from outside the hazardous space.

2.2.8.2 Doors or hatches to hazardous spaces shall bear on the outside the symbol corresponding to Figure 1 in Annex 4 ("No entry for unauthorised persons") as well as the fuel specific symbol in accordance with Article 30.06.

2.2.8.3 The inspection body may allow derogation to (2.2.8.1), provided that

- a) the opening of the space leads directly to open deck;
- b) the opening of the space is through an air lock;
- c) the space is considered as non-hazardous in accordance with Article 10.04; or
- d) the entering of the space does not lead to extending any zone to where a source of ignition is present.

Before allowing a derogation according to d), a classification and evaluation of areas at risk of explosion in accordance with Article 10.04 shall be conducted with accesses opened. Non-hazardous spaces to which a hazardous area could extend while accessing the hazardous space shall be appropriately marked.

2.2.8.4 Air locks shall be mechanically ventilated at an overpressure relative to the adjacent hazardous space. Doors shall be of self-closing type and shall not be fitted with holding back arrangements.

2.2.8.5 Air locks shall be designed in a way that no gas can be released to non-hazardous spaces in case of the most critical events in the hazardous spaces separated by the air lock. The events shall be evaluated in the risk assessment according to Article 30.04.

2.2.8.6 Air locks shall be free of obstacles, shall provide easy passage and shall not be used for other purposes.

2.2.8.7 An optical and acoustic alarm shall be given on both sides of the air lock, if more than one door is not closed or if gas is detected in the air lock.

2.2.9 Ventilation systems

2.2.9.1 Any ducting used for the ventilation of hazardous spaces shall be separate from that used for the ventilation of non-hazardous spaces.

2.2.9.2 The ventilators used for ventilation of hazardous spaces shall be of a certified safe type.

2.2.9.3 Electric motor driving ventilators shall comply with the required explosion protection in the area where it is installed.

2.2.9.4 An optical and acoustic alarm shall be triggered in the wheelhouse or at any other permanently manned location in the event of any loss of the required ventilating capacity.

2.2.9.5 Ventilation systems required to avoid any explosive atmosphere shall have at least two ventilators with independent power supply, each of sufficient capacity. This requirement does not apply for ventilation of spaces that do not require continuous ventilation.

2.2.9.6 It shall be possible to safely ventilate overboard the spaces where methanol fuel may accumulate to ensure a safe atmosphere when entering the spaces is necessary.

2.2.9.7 Air for ventilation of hazardous spaces shall be taken from non-hazardous areas.

2.2.9.8 Air for ventilation of non-hazardous spaces shall be taken from non-hazardous areas which are located at least 1,50 m from the boundaries of any hazardous area.

2.2.9.9 Where the outlet duct from a hazardous space passes through a non-hazardous space, the duct shall have underpressure relative to this space. Underpressure shall not be required when structural measures on the duct ensure that gases cannot leak into the room.

2.2.9.10 Where an inlet duct passes through a hazardous space, the duct shall have overpressure relative to this space. Overpressure shall not be required if it is ensured that gases cannot leak into the duct.

2.2.9.11 Air outlets from hazardous spaces shall be located in an open area which has the same or less hazard than the ventilated space.

2.2.9.12 Air outlets from non-hazardous spaces shall be located outside any hazardous area.

2.2.10 Methanol bunkering system

2.2.10.1 Bunkering stations shall be located on open deck so that sufficient natural ventilation is provided. However, the inspection body may accept enclosed or semi-enclosed bunkering stations subject to special consideration with respect to provisions for mechanical ventilation.

- 2.2.10.2 Bunkering stations shall be so positioned and arranged that any damage to the methanol fuel piping does not cause damage to the craft's methanol tank system.
- 2.2.10.3 Suitable means shall be provided to relieve the pressure and remove liquid contents from bunker piping.
- 2.2.10.4 Each fuel tank filler neck shall be designed to withstand the mechanical loads during bunkering.
- 2.2.10.5 The coupling of the bunkering system shall be in accordance with European Standard EN 14420-6 : 2013.

The need for a safety dry break-away coupling shall be considered in the risk assessment in accordance with Article 30.04.

2.2.11 Methanol fuel supply system

- 2.2.11.1 The methanol fuel supply system to each room or space with consumers shall be equipped with a remotely controlled master fuel valve to shut-off fuel supply lines to consumers. The master fuel valve shall be situated outside the room or space where the consumers are located. For tanks serving only one room or space, the master fuel valve may be combined with the quick closing tank valve.
- 2.2.11.2 The master fuel valve shall be operable
- within and outside the engine room (if present),
 - from the inside and outside of the fuel cell space (if present), and
 - from the wheelhouse.
- 2.2.11.3 The arrangement of the methanol fuel supply system shall ensure safe isolation during maintenance work.

2.2.12 Fire Safety

- 2.2.12.1 In addition to Article 30.08, the following provisions apply.
- 2.2.12.2 Spaces, where equipment containing fuel is installed and where a fire hazard cannot be excluded, shall comply with the fire protection requirements for engine rooms. These requirements are deemed fulfilled when:
- walls, ceilings, doors and hatches of this space is made of steel or another equivalent non-combustible material;
 - insulation material used in this space is protected against the intrusion of fuel and fuel vapours;
 - all openings in walls, ceilings, doors and hatches of this space can be closed from outside the space. The locking devices shall be made from steel or an equivalent non-combustible material; and
 - this space is equipped with a permanently installed firefighting system in accordance with Articles 13.05 or 13.06.

The firefighting system referred to in (d) is not required in small enclosed spaces which do not contain source of ignition.

Continuously operated electric motors, even if certified as safe according to Article 1.01(3.24), shall be considered a source of ignition, unless they are protected against overheating.

- 2.2.12.3 Suitable fire detectors shall be selected based on the characteristics of the fuel. Smoke detectors shall be used only in combination with other detectors which can more effectively detect methanol fires.
- 2.2.12.4 The fire detection system shall have the means to identify each detector individually.
- 2.2.12.5 At least one portable fire extinguisher in accordance with Article 13.03(2) shall be available on deck no more than 10 m walking distance away from each bunkering stations.

2.2.13 Control, Monitoring and Safety Systems

2.2.13.1 General

2.2.13.1.1 In addition to Article 30.10, the following provisions apply.

2.2.13.1.2 Without prejudice to Article 30.07, upon failure in systems essential for the safety and upon fault conditions which may develop too fast for manual intervention, the methanol fuel safety system shall shut down the fuel supply system automatically.

2.2.13.1.3 The safety functions shall be arranged in a dedicated fuel safety system that is independent of the fuel control system.

2.2.13.1.4 Instrumentation devices shall be fitted to allow a local and a remote reading of essential parameters, where they are necessary to ensure a safe operation of the whole methanol fuel system including the bunker system.

2.2.13.1.5 It shall be possible to manually shut down the methanol fuel supply system from the wheelhouse or a permanently manned location as applicable.

2.2.13.2 Methanol fuel tank and bunkering system

2.2.13.2.1 Each methanol fuel tank shall be fitted with:

- a) at least one closed level gauging device, which must be positioned close to the tank in such a way that the level reading is always obtainable;
- b) an independent sensor (high-high level) triggering an optical and acoustic alarm and allowing to automatically stop the bunkering at 95 % full; and
- c) an optical and acoustic high-level alarm. This shall be able to be functionally tested from the outside of the tank and can be common with the alarm of the level gauging device according to (a), configured as an alarm on the gauging transmitter, but shall be independent of the high-high level alarm according to (b).

2.2.13.2.2 A ship-shore link shall be fitted for automatic and manual transmission of the bunkering stop order to the bunkering source.

At least the signal of the high-high level sensor shall be transmitted to the bunkering station by means of a watertight connection plug meeting the requirements of International Standard IEC 60309-1 : 2021 for 40 to 50 V DC, housing colour white, earthing contact position ten o'clock.

2.2.13.2.3 Provisions shall be made that the bunkering can be supervised and stopped at any time. Overfill alarm and automatic shutdown shall be indicated.

2.2.13.2.4 If a leakage into the interbarrier space of the bunkering line is detected, an optical and acoustic alarm and automatic shutdown of the bunkering shall be initiated.

2.2.13.2.5 Each shore connection for liquids and vapours shall be provided with at least one local pressure indicator. The permissible maximum pressure or vacuum value shall be indicated on each indicator.

2.2.13.2.6 For inerted tanks, means shall be provided that the tanks cannot be overpressurised by the inert gas system.

2.2.13.3 Gas and leakage warning equipment

2.2.13.3.1 Spaces where methanol fuel vapours may accumulate shall be equipped with permanently installed means of fuel leakage detection.

The number, type and redundancy of detectors in each space shall correspond to the size, layout and ventilation of the space.

The effectiveness of leakage detection shall be demonstrated. For gas detectors, this is deemed fulfilled when a gas dispersal analysis or a physical smoke test is used to find the best arrangement.

2.2.13.3.2 Permanently installed gas detection shall be provided for:

- a) enclosed or semi-enclosed rooms,
 - aa) where fuel vapours may accumulate, and
 - bb) which contain a source of ignition.
- b) air locks, and
- c) air outlets of ventilated spaces where a fuel leakage could remain undetected in the space.

2.2.13.3.3 Gas warning equipment shall be designed, installed and tested in accordance with a Standard recognized by one of the Member States, such as European Standard EN 60079-29-1 : 2020.

2.2.13.3.4 In the event of a fuel vapour concentration above 20 % of the lower explosion limit (LEL), an optical and acoustic alarm shall be triggered in the wheelhouse or at any other permanently manned location.

The automatic shutdown required by (2.2.13.1.2) shall be activated at the latest at a fuel vapour concentration of 40 % of the lower explosion limit (LEL).

2.2.13.4 Provisions on safety functions of fuel supply systems

2.2.13.4.1 The safety system shall be manually reset before the propulsion or auxiliary system can be restarted.

Chapter 3 Hydrogen

(left void)

Section III **Energy converters**

Chapter 1 **Propulsion and auxiliary systems with fuel cells**

3.1.1 Fuel cell spaces

- 3.1.1.1 The requirements of this Chapter shall apply to fuel cell spaces located either on deck or below deck.
- 3.1.1.2 Only components necessary for the operation of the fuel cell systems shall be permitted in fuel cell spaces.
- 3.1.1.3 Fuel cell components shall be surrounded by a secondary barrier. The boundary of a fuel cell space may act as a secondary barrier.
- 3.1.1.4 Fuel cell spaces shall be designed in such a way that their geometrical form ensures good air circulation or good distribution of inert gas, as to minimise the possibility of entrapping explosive mixture.
- 3.1.1.5 A permanently installed, continuously measuring gas detection system shall be in place in fuel cell spaces.
- 3.1.1.6 Fuel cell spaces containing fuel reformers shall also comply with the requirements for the relevant fuel storage in accordance with Annex 8, Section II.
- 3.1.1.7 Appropriate fire partition requirements of fuel cell spaces shall be established by the risk assessment in accordance with Article 30.04, with special consideration given to the installation location and fire load of the fuel cell space.
- 3.1.1.8 Fuel cell spaces shall not be located less than:
- a) 1,00 m or B/5 from the craft's side whichever is less, and
 - b) 0,60 m from the craft's bottom.
- The inspection body may allow shorter distances in the absence of hazardous areas, based on the risk assessment, according to Article 30.04.
- 3.1.1.9 One of the following concepts shall be applied to fuel cell spaces:
- a) inerted fuel cell space,
 - b) explosion-protected fuel cell space, or
 - c) ventilated fuel cell space.

3.1.1.10 Requirements for inerted fuel cell spaces

3.1.1.10.1 Inerted fuel cell spaces are fuel cell spaces protected by inert gas. They shall be considered as non-hazardous areas.

3.1.1.10.2 The boundary of the fuel cell space that acts as secondary barrier shall be gastight. The design pressure of the boundary shall be suitable for the intended application.

3.1.1.10.3 During normal operation of the fuel cell system, the fuel cell space shall be inerted.

3.1.1.10.4 In the event of leakage of gas being detected or loss of inertion:

- a) the fuel supply to the fuel cell space concerned, and
- b) the fuel cell components in the fuel cell space concerned shall be shut down automatically.

3.1.1.10.5 Gas tightness and integrity of the secondary barrier shall be permanently monitored by appropriate measures. In the event of leakage of inerted gas being detected in adjacent rooms where persons are present during normal operation, an optical and acoustic alarm shall be triggered

- a) in the affected rooms and
- b) in the wheelhouse or at any other permanently manned location.

In the event of failure of the gas tightness and integrity of the secondary barrier, the fuel supply to the fuel cell system shall be shut down automatically.

3.1.1.11 Requirements for explosion-protected fuel cell spaces

3.1.1.11.1 Explosion-protected fuel cell spaces shall be considered as hazardous areas (Zone 1).

3.1.1.11.2 In accordance with Article 10.04, only explosion-protected equipment (certified safety) is permitted. This shall be deemed to be fulfilled if the equipment meets the relevant provisions of the European Standard series EN 60079.

3.1.1.11.3 By way of derogation from (3.1.1.3), the function of the secondary barrier shall be achieved by mechanical ventilation ensuring permanent negative pressure relative to adjacent rooms.

3.1.1.11.4 The ventilation system shall:

- a) guarantee a sufficient capacity of ventilation to ensure that the gross volume of air inside the fuel cell space is changed at least 30 times per hour, and
- b) be independent of all other ventilation systems of the craft.

3.1.1.11.5 In the event of leakage of gas leading to a concentration above 20 % of the lower explosive limit (LEL), an optical and acoustic alarm shall be triggered in the wheelhouse or at any other permanently manned location.

3.1.1.11.6 In the event of leakage of gas leading to a concentration above 40 % of the LEL or the ventilation system fails,

- a) the fuel supply to the fuel cell space concerned, and
 - b) the fuel cell components in the fuel cell space concerned
- shall be shut down automatically.

3.1.1.12 Requirements for ventilated fuel cell spaces

3.1.1.12.1 The possible hazardous areas within the ventilated fuel cell spaces shall be classified in accordance with Article 10.04.

3.1.1.12.2 In accordance with Article 10.04, only equipment suitable for the hazardous areas as classified in (3.1.1.12.1) is permitted. This shall be deemed to be fulfilled if the equipment meets the relevant provisions of the European Standard series EN 60079.

3.1.1.12.3 By way of derogation from (3.1.1.3), the function of the secondary barrier shall be achieved by mechanical ventilation ensuring permanent negative pressure relative to adjacent rooms.

3.1.1.12.4 The ventilation system shall:

- a) guarantee a sufficient capacity of ventilation to ensure that the gross volume of air inside the fuel cell space is changed at least at the rate which has been assumed for the hazardous area calculation referred to in (3.1.1.12.1). This shall be deemed to be fulfilled if the dilution is determined in accordance with Article 10.04(1), and
- b) be independent of all other ventilation systems of the craft.

3.1.1.12.5 In the event of leakage of gas leading to a concentration above 20 % of the LEL, an optical and acoustic alarm shall be triggered in the wheelhouse or at any other permanently manned location.

3.1.1.12.6 In the event of leakage of gas leading to a concentration above 40 % of the LEL or the ventilation system fails:

- a) the fuel supply to the fuel cell space concerned and
 - b) the fuel cell components in the fuel cell space concerned
- shall be shut down automatically.

3.1.1.13 Specific requirements or derogations for fuel cell spaces on deck

3.1.1.13.1 For fuel cell spaces on deck, the inspection body may allow derogation from (3.1.1.3) and (3.1.1.12.3) provided that:

- a) the fuel cell space is located on open deck with no directly adjacent rooms on the same deck;
- b) the fuel cell space is naturally ventilated to ensure that the gross volume of air inside the fuel cell space is changed in accordance with (3.1.1.12.4);
- c) the risk assessment according to Article 30.04 does not identify any contraindication.

3.1.1.14 Access to fuel cell spaces

3.1.1.14.1 Access to fuel cell spaces shall not be possible before the fuel cell components inside are safely shut down, isolated from the fuel supply system, drained of leakages and the inside atmosphere is confirmed gas-free.

It shall be possible to remotely operate and monitor from outside the fuel cell space all controls and all parameters required for safe operation of the fuel cell system and gas freeing of the fuel cell space.

3.1.1.14.2 The fuel cell space openings shall be equipped with an interlock preventing operation of the fuel cell system when the fuel cell space is open.

3.1.1.14.3 Doors to fuel cell spaces shall bear on the outside the symbol corresponding to Figure 1 in Annex 4 ("No entry for unauthorised persons") as well as the fuel specific symbol in accordance with Article 30.06.

3.1.1.14.4 For the purpose of entering the inerted fuel cell spaces, it shall be possible that the inerted atmosphere in the fuel cell space is replaced by air that is safe to breathe. It shall be indicated outside the fuel cell space whether the air is safe to breathe.

3.1.1.14.5 The inspection body may allow derogation to (3.1.1.14.1), provided that:

- a) the opening of the fuel cell space leads directly to open deck,
- b) the opening of the fuel cell space is through an air lock, or
- c) the fuel cell space is considered as non-hazardous in accordance with (3.1.1.12.1).

3.1.1.14.6 For safe maintenance, it shall be possible that the fuel cell components are:

- a) isolated from the fuel supply system, and
- b) drained and purged of fuel.

3.1.1.14.7 Fuel cell systems and their components shall be installed and fitted in such a way as to be adequately accessible for operation and maintenance and shall not endanger the persons assigned to those tasks.

3.1.2 Fuel Piping systems in the fuel cell spaces

3.1.2.1 The piping used for the supply of primary fuel shall comply with the respective requirements of Annex 8 Section II.

3.1.2.2 Fuel piping shall be protected against hazards arising from electrostatic charges.

3.1.2.3 The maximum working pressure for piping inside fuel cell spaces shall not exceed 1000 kPa (gauge value). The inspection body may allow higher working pressure, based on the risk assessment according to Article 30.04.

3.1.3 Reformer

3.1.3.1 The volume of fuel in the reformer shall be limited to the volume required for a stable continuous operation. Storage of fuel in the reformer shall not be permitted.

3.1.3.2 Reformer with a design pressure of more than 50 kPa shall comply with the requirements of Article 8.01(2).

3.1.3.3 Unintended accumulations of inflammable mixtures in burner systems and oxidation units of the reformer shall be avoided.

3.1.3.4 An automatic burner control system shall be installed to enable the safe start, operation and shutdown of the burner system of the reformer.

3.1.3.5 The complete combustion of the gases in the burner shall be monitored.

3.1.3.6 Surfaces likely to reach high temperatures shall be provided with insulation or protection against contact.

3.1.4 Buffer vessel

3.1.4.1 Fuel buffer vessels in fuel cell systems, if present, may only be used to provide process-related fuel and temporary reserves but not as an additional fuel storage.

3.1.4.2 The buffer vessels shall be arranged near the fuel cells and shall comply with the requirements of (3.1.2).

3.1.5 Fuel cell systems

3.1.5.1 Fuel cell systems shall be constructed and tested in accordance with the applicable standards of the International Standards series IEC 62282 or equivalent standards.

3.1.5.2 Materials used for the fuel cell systems shall be suitable for the intended application. This shall be deemed to be fulfilled when the materials comply with:

- a) the International Standard IEC 62282-3-100 : 2019 or
- b) an equivalent regulation or Standard recognised by one of the Member States.

3.1.6 Ventilation systems

3.1.6.1 The ventilators used for ventilation of hazardous areas shall be of a certified safe type.

3.1.6.2 Electric motor driving ventilators shall comply with the required explosion protection in the area where it is installed.

- 3.1.6.3 An optical and acoustic alarm shall be triggered in the wheelhouse or at any other permanently manned location in the event of any loss of the required ventilating capacity.
- 3.1.6.4 At least two ventilators shall be installed for the ventilation of hazardous areas to guarantee 100 % of the required ventilation capacity if one ventilator fails. The supply from the emergency power source shall also enable the ventilation system to provide 100% of the required ventilation capacity.
- 3.1.6.5 Air for ventilation of hazardous spaces shall be taken from non-hazardous areas.
- 3.1.6.6 The air for ventilation of non-hazardous areas shall be taken from non-hazardous areas which are located at least 1,50 m away from the boundaries of any hazardous area.
- 3.1.6.7 Where the inlet duct passes through a hazardous room, the duct shall have overpressure relative to this room. Overpressure shall not be required if it is ensured that gases cannot leak into the duct.
- 3.1.6.8 Air outlets from hazardous areas shall be located in an open area which has the same or less hazard than the ventilated room.
- 3.1.6.9 Air outlets from non-hazardous areas shall be located outside any hazardous area.
- 3.1.6.10 Air inlets and outlets shall be located in appropriate positions, taking into account the characteristics of the fuel used.

3.1.7 Exhaust systems

- 3.1.7.1 The following provisions apply to systems for exhaust air and exhaust gas from fuel cell systems.
- 3.1.7.2 The exhaust systems of the fuel cell systems shall
- a) not be connected to the exhaust pipes of systems other than fuel cell systems and
 - b) shall lead the gases to open air.
- However, the exhaust pipes of the fuel cell systems may be combined with the fuel cell space ventilation at the ventilation outlet of the fuel cell space, provided that the exhaust gases of one fuel cell system cannot escape into another fuel cell system.
- 3.1.7.3 The exhaust systems shall be made of an appropriate material regarding its temperature limit, fire resistance, material strength and resistance to the action of condensate.
- 3.1.7.4 All suitable measures shall be taken to avoid ingress of exhaust air and exhaust gas into the various compartments of the craft.
- 3.1.7.5 Outlets of exhaust systems shall be designed in such a way that they cause no immediate danger to the people on board. They shall be located in appropriate positions, taking into account the characteristics of the exhaust air and exhaust gas.

- 3.1.7.6 The exhaust systems and their outlets are to be classified in accordance with Article 10.04. Only equipment suitable for the hazardous area as classified is permitted.
- 3.1.7.7 The exhaust systems shall be configured to keep accumulation of unoxidized gaseous fuel as low as possible.
- 3.1.7.8 Routing and isolation of the exhaust system shall take the accumulation of condensate into account.
- 3.1.7.9 Exhaust gas systems must allow safe condensate drainage.
- 3.1.7.10 If the exhaust systems are not provided by the fuel cell manufacturer, they must comply with the fuel cell manufacturer's instructions.

3.1.8 Purging system

- 3.1.8.1 For fuel cell systems requiring purging for safe operation, especially before the start-up or after the shutdown of the fuel cell system, a suitable purging system that uses a medium specified by the fuel cell manufacturer shall be used.

3.1.9 Control, monitoring and safety systems

- 3.1.9.1 In addition to Article 30.10, the provisions of (3.1.9) apply.
- 3.1.9.2 Each fuel cell system shall be fitted with its own control and monitoring system and its own safety system. The safety system shall be designed to operate independently of the control and monitoring system. All elements of these systems shall be capable of being functionally tested.
- Software for programmable electronic systems shall be developed in accordance with an acceptable quality management system considering all software lifecycle activities as design, development, supply and maintenance.
- 3.1.9.3 Sensors for the safety system shall be first routed to safety system and particular information may be also routed towards control and monitoring systems. Alarm sensors shall be directly routed to the monitoring system.
- 3.1.9.4 It shall be possible to manually shut down the fuel cell system from the following locations:
- wheelhouse,
 - from the outside in the direct vicinity of the fuel cell space,
 - any permanently manned location.

The safety system shall be manually reset before the propulsion or auxiliary system can be restarted.

- 3.1.9.5 Suitable devices shall monitor chemical reactions in the reformer and in the fuel cells by means of temperature, pressure and voltage control.

Chapter 2

Propulsion and auxiliary systems with internal combustion engines using LNG as fuel

3.2.1 General

- 3.2.1.1 Requirements of Annex 8, Section II, 2.1.2 to 2.1.6, 2.1.9, 2.1.10, 2.1.11.1, 2.1.11.2, 2.1.13.1, 2.1.13.3 and 2.1.13.4 also apply to propulsion and auxiliary systems with internal combustion engines using LNG as fuel.
- 3.2.1.2 One of the following concepts shall be applied to engine rooms:
- gas safe engine room,
 - explosion safe engine room or
 - ESD protected engine room.

3.2.2 Requirements for gas safe engine rooms

- 3.2.2.1 Gas safe engine rooms shall be gas safe under all conditions ("inherently gas safe"). A single failure within the LNG system shall not lead to a leakage of gas into the engine room. All gas piping within engine room boundaries shall be enclosed in a gas tight enclosure, e.g. double wall piping or ventilated ducting.
- 3.2.2.2 In case one barrier fails, the gas supply to the relevant part of the LNG system shall be shut down automatically.
- 3.2.2.3 In addition to the provision of (2.1.6), the ventilation system of ventilated ducting shall:
- guarantee a sufficient capacity to ensure that the gross volume of air inside the ventilated ducting can be changed at least 30 times per hour;
 - be equipped to detect gas presence continuously in the space between inner and outer pipes; and
 - be independent of all other ventilation systems, in particular the ventilation system of the engine room.
- 3.2.2.4 Gas safe engine rooms shall be considered as non-hazardous areas, unless the risk assessment according to Article 30.04 demonstrates otherwise.

3.2.3 Requirements for explosion safe engine rooms

- 3.2.3.1 Arrangements in explosion safe engine rooms shall be such that the rooms are considered gas safe under normal conditions. A single failure within the LNG system shall not lead to a gas concentration over 20 % of the lower explosive limit (LEL) into the engine room.
- 3.2.3.2 In the event of gas being detected or the ventilation system failing, the gas supply to the relevant part of the LNG system shall be shut down automatically.

- 3.2.3.3 In addition to the provision of (2.1.6), the ventilation system shall:
- guarantee a sufficient capacity to maintain gas concentration below 20 % of the LEL in the engine room, and to ensure that the gross volume of air inside the engine room can be changed at least 30 times per hour; and
 - be independent of all other ventilation systems of the craft.
- 3.2.3.4 Under normal operation the engine room shall be permanently ventilated with at least 15 changes of the gross volume of air inside the engine room per hour.
- 3.2.3.5 Explosion safe engine rooms shall be designed to provide a geometrical shape that minimises the accumulation of gases or formation of gas pockets. A good air circulation shall be ensured.
- 3.2.3.6 Explosion safe engine rooms shall be considered as Zone 2, unless the risk assessment according to Article 30.04 demonstrates otherwise.
- 3.2.4 Requirements for the ESD protected engine rooms**
- 3.2.4.1 Arrangements in ESD protected engine rooms shall be such that the rooms are considered gas safe under normal conditions, but under certain abnormal conditions may have the potential to become subject to gas hazards.
- 3.2.4.2 In the event of abnormal conditions involving gas hazards, emergency shutdown (ESD) of non-safe equipment (ignition sources) and gas machinery shall be automatically executed, while equipment or machinery in use or active during these conditions shall be of a certified safe type.
- 3.2.4.3 In addition to the provision of (2.1.6), the ventilation system shall:
- guarantee a sufficient capacity to ensure that the gross volume of air inside the engine room can be changed at least 30 times per hour,
 - be designed to handle the probable maximum leakage due to technical failures, and
 - be independent of all other ventilation systems of the craft.
- 3.2.4.4 Under normal operation the engine room shall be permanently ventilated with at least 15 changes of the gross volume of air inside the engine room per hour.
If gas is detected in the engine room, the number of air changes shall automatically be increased to 30 changes per hour.
- 3.2.4.5 If the craft is equipped with more than one propulsion engine, these engines shall be located in at least two separate engine rooms. These engine rooms shall have no common partitions. However, common partitions may be accepted, if it can be documented that any consequences of a single failure will not affect both rooms.
- 3.2.4.6 Fixed gas warning equipment arranged to automatically shut down the gas supply to the engine room concerned and to disconnect all non-explosion protected equipment or installations shall be fitted.

3.2.4.7 ESD protected engine rooms shall be designed to provide a geometrical shape that minimises the accumulation of gases or formation of gas pockets. A good air circulation shall be ensured.

3.2.4.8 ESD protected engine rooms shall be considered as Zone 1, unless the risk assessment according to Article 30.04 demonstrates otherwise.

3.2.5 Exhaust system

3.2.5.1 Exhaust systems shall be configured to keep accumulation of unburnt gaseous fuel as low as possible.

3.2.5.2 Unless designed with the strength to withstand the worst case of overpressure due to ignited gas leaks, engine components or systems that can contain an ignitable gas and air mixture, shall be fitted with suitable pressure relief devices.

3.2.5.3 Means shall be provided to monitor and detect incorrect operation of the ignition system, poor combustion or misfiring that may lead to unburnt gaseous fuel in the exhaust system during operation.

3.2.5.4 The exhaust pipes of gas or dual fuel engines shall not be connected to the exhaust pipes of other engines or systems.

3.2.6 Engines

3.2.6.1 Indicators shall be fitted in the wheelhouse and the engine room for:

- a) operation of the engine in case of a gas-only engine, or
- b) operation and mode of operation of the engine in the case of a dual fuel engine.

3.2.6.2 If incorrect operation of the ignition system, poor combustion or misfiring is detected, the gas supply system shall be shut down automatically.

3.2.6.3 In case of shut-off of the gas supply system in a dual fuel engine, the engine shall be capable of continuous operation on gasoil only without interruption. If the fuel supply is not changed over to gasoil before shutting off the dual fuel engine, the gas supply system from the master fuel valve to the engine and the exhaust system shall be purged in order to discharge any residual gas which may be present.

Chapter 3

Propulsion and auxiliary systems with internal combustion engines using methanol as fuel

3.3.1 General

- 3.3.1.1 Equipment and piping containing liquid methanol fuel shall be arranged in enclosures, spaces or ducts providing a secondary barrier. This requirement applies notably to pump filters and fittings.
- 3.3.1.2 The requirements of Annex 8, Section II, (2.2.6), (2.2.7), (2.2.8), (2.2.9), (2.2.11), (2.2.12), (2.2.13) apply also to propulsion and auxiliary systems with internal combustion engines using methanol as fuel.
- 3.3.1.3 One of the following concepts shall be applied to engine rooms:
- gas safe engine room, or
 - ventilated engine room.

All other spaces where machinery is installed which uses methanol as fuel, such as pump rooms or boiler rooms, shall be subjected to the same requirement as engine rooms.

3.3.2 Requirements for gas safe engine rooms

- 3.3.2.1 Gas safe engine rooms shall be gas safe under all conditions ("inherently safe concept"). A single failure within the methanol system shall not lead to a leakage of methanol into the engine room.
- 3.3.2.2 Methanol piping and equipment within the engine room boundaries shall be surrounded by a secondary barrier for leakage containment and detection in accordance with the requirements in (a) or (b).
- Methanol piping shall be double wall piping with the methanol contained in the inner pipe. The design pressure of the secondary barrier around the inner pipe shall not be less than the maximum working pressure of the inner pipe. As an alternative the secondary barrier around the inner pipe shall be dimensioned in accordance with the calculated maximum built-up pressure in case of pipe rupture. Suitable alarms shall be provided to detect and indicate leakage from the inner pipe. An optical and acoustic alarm shall be triggered in the wheelhouse or at any other permanently manned location in the event of the inner barrier failing or detection of leakage.
 - Methanol piping and equipment shall be installed within ventilated ducts or enclosures. The interbarrier space between the methanol piping (or equipment) and the wall of the duct or enclosure shall be equipped with mechanical extraction ventilation having a capacity of at least 6 air changes per hour. The ventilation system shall comply with the requirements of (2.2.9).

Methanol leakage inside the ventilated ducts or enclosures shall be detected by means of suitable detectors in accordance with (2.2.13.3). Methanol leakage must be safely collected and drained by means of leakage collecting arrangements. An optical and acoustic alarm shall be triggered in the engine room and in the wheelhouse or at any other permanently manned location in the event of

- aa) the detection of leakage in the interbarrier space,
- or
- bb) the ventilation system failing.

3.3.2.3 Gas safe engine rooms shall be considered as non-hazardous areas, unless the risk assessment according to Article 30.04 demonstrates otherwise.

3.3.3 Requirements for ventilated engine rooms

3.3.3.1 The possible hazardous areas within the ventilated engine rooms shall be classified in accordance with Article 10.04.

3.3.3.2 In accordance with Article 10.04, only equipment suitable for the hazardous areas as classified according to (3.3.3.1) is permitted. This shall be deemed to be fulfilled if the equipment meets the relevant provisions of the European Standard series EN 60079.

3.3.3.3 By way of derogation from (3.3.1.1), the function of the secondary barrier shall be achieved by mechanical ventilation ensuring permanent negative pressure relative to adjacent rooms.

3.3.3.4 In addition to the provision of (2.2.9), the ventilation system shall:

- a) guarantee a sufficient capacity to ensure that the gross volume of air inside the engine room can be changed at least 6 times per hour,
- b) be designed to handle and purge the probable maximum leakage due to technical failures, as assumed for the hazardous areas calculation referred to in (3.3.3.1), and
- c) be independent of all other ventilation systems.

3.3.3.5 In the event of leakage leading to a methanol vapour concentration above 250 ppm in the engine room, an optical and acoustic alarm shall be triggered in

- a) the engine room, and
- b) the wheelhouse or at any other permanently manned location.

3.3.3.6 In the event of leakage leading to a methanol vapour concentration above 40 % of the lower explosion limit (LEL) in the engine room or the ventilation system failing:

- a) the methanol supply to the engine room concerned shall be shut down automatically then
- b) the methanol components in the engine room concerned shall be shut down automatically.

- 3.3.3.7 If the craft is equipped with more than one propulsion engine, these engines shall be located in at least two separate engine rooms. These engine rooms shall have no common partitions. However, common partitions may be accepted, if it can be documented that any consequences of a single failure will not affect both rooms. In accordance with the risk assessment referred to in Article 30.04, the inspection body may allow propulsions engines in the same ventilated engine room, provided that hazardous areas in the ventilated engine room are being determined to be of negligible extent.
- 3.3.3.8 Ventilated engine rooms shall be designed to provide a geometrical shape that minimises gas release from leakage pools as well as the accumulation of gases or formation of gas pockets. Good air circulation shall be ensured. Air inlets and outlets shall be located in appropriate positions, taking into account the characteristics of methanol.
- 3.3.3.9 Suitable alarms shall be provided to detect and indicate a leakage in the engine room, by means of liquid detectors and high sensitivity gas detectors at suitable places, in accordance with (2.2.13.3).
- 3.3.3.10 Drip trays with self-draining lines to closed collecting tanks shall be provided under all equipment which contain methanol and from where leakage cannot be excluded.
- 3.3.3.11 Spray guards shall be provided on pipes and joints where fuel spray cannot be excluded.
- 3.3.3.12 At least two portable methanol detectors shall be available. The safety rota referred to in Article 30.05(1) shall include instructions for the use and calibration of the portable detectors. Doors of ventilated engine rooms shall bear on the outside the following readily legible instruction: 'Access to engine room only with portable methanol detector'.
- 3.3.4 Engines**
- 3.3.4.1 In accordance with (3.3.1.1), engine components containing liquid methanol shall be effectively sealed to prevent leakage of fuel into the engine room.
- 3.3.4.2 For engines where the space below the piston is in direct communication with the crankcase, a detailed evaluation regarding the hazard potential of fuel gas accumulation in the crankcase shall be carried out and reflected in the safety concept of the engine.
- 3.3.4.3 Means shall be provided to monitor and detect incorrect operation of the ignition system, poor combustion and misfiring that may lead to unburnt fuel in the exhaust system or in the crankcase.

- 3.3.4.4 If incorrect operation of the ignition system, poor combustion or misfiring is detected, the control system shall trigger an optical and acoustic alarm signal in the wheelhouse. A continued operation may only be allowed to ensure the craft of making steerageway under its own power and provided that
- the fuel supply to concerned cylinders can be shut off,
 - the engine manufacturer has declared the engine to be able to operate safely with one or more cylinders cut-off with respect to torsional vibrations, and
 - the instructions for the boatmaster according to letter a) are displayed in the wheelhouse close to the controls of the engine.
- 3.3.4.5 In case of an emergency stop or a normal stop, the supply of methanol shall be automatically shut off not later than
- the supply of the other fuel for dual fuel engines. It shall not be possible to shut off the other fuel without first or simultaneously closing the methanol supply to the respective cylinders or to the complete engine.
 - the ignition source for single fuel engines. It shall not be possible to shut off the ignition source without first or simultaneously closing the methanol supply to the respective cylinders or to the complete engine.
- 3.3.5 Exhaust system**
- 3.3.5.1 Exhaust systems shall be configured to keep accumulation of unburnt fuel as low as possible.
- 3.3.5.2 Exhaust pipes of methanol engines shall not be connected to exhaust pipes of other engines or systems.

Chapter 4

Propulsion and auxiliary systems with internal combustion engines using hydrogen as fuel

(left void)

INSTRUCTIONS FOR THE APPLICATION OF THE TECHNICAL STANDARD

PART I GENERAL

ESI-I-1

COMPLETION OF THE INLAND NAVIGATION VESSEL CERTIFICATES

1. General

1.1 Forms

For completion of the inland navigation vessel certificate only forms authorised by the competent authority shall be used. Forms shall be filled in on one side only.

When issuing a new inland navigation vessel certificate, all pages 1 to 13 shall be included, even if some pages have no entries.

1.2 Method of entry

Entries on the inland navigation vessel certificate shall be typewritten or computer-printed. Hand written entries may only be made in exceptional cases. The entries shall be indelible. Font colours shall be black or blue only. Deletions shall be made in red.

2. Entries

2.1 Deletion of alternatives

Where entries are marked with ^(*) those which are not applicable shall be deleted.

2.2 Items without entry

If, for any of the items 1 to 48, no entry is either necessary or possible, a line shall be drawn across the entire field.

2.3 Final page of the inland navigation vessel certificate

If no additional pages are required after page 13 (see (3.2.3)), the words 'continued on page'^(*) at the bottom of page 13 shall be deleted.

2.4 Amendments

2.4.1 First handwritten amendment on a page

A page can be amended once only, however, several amendments may be made at that time. A red line shall be drawn through any details to be amended. A previously deleted alternative (see (2.1)) or an item previously without entry (see (2.3)) shall be underlined in red. The new details shall not be entered in the amended field, but on the same page under the heading 'Amendments', the line 'This page has been replaced' shall be deleted.

^(*) Delete as appropriate.

2.4.2 Further handwritten amendments on a page

For further amendments the page shall be replaced and the necessary amendments as well as any earlier amendments shall be entered directly under the appropriate items. Under the heading 'Amendments' the line 'amendments to item(s)' shall be deleted.

The old page shall be retained by the inspection body which originally issued the inland navigation vessel certificate.

2.4.3 Amendments by electronic data processing

In case of amendments by electronic data processing, the page shall be replaced and the necessary amendments as well as any earlier amendments shall be entered directly under the appropriate items. Under the heading 'Amendments' the line 'amendments to item(s)' shall be deleted.

The old page shall be retained by the inspection body which originally issued the inland navigation vessel certificate.

2.5 Corrections by pasting over

Pasting over of entries or pasting in further details added to an item is not allowed.

3. Replacing and adding pages

3.1 Replacing pages

Page 1 of the inland navigation vessel certificate shall never be replaced. For replacing other pages the procedures outlined in (2.4.2) or (2.4.3) shall be applied.

3.2 Adding pages

If there is insufficient space for further entries on pages 10, 12 or 13 of the inland navigation vessel certificate, additional pages may be attached.

3.2.1 Extension/Confirmation of validity

If further extension is necessary when the certificate has already been extended six times, the words 'Continued on page 10a' shall be added at the bottom of page 10, and a further page 10 shall be marked as page 10a and inserted after page 10. The respective entry is then made under item 49 at the top of page 10a. At the bottom of page 10a the entry 'Continued on page 11' shall be made.

3.2.2 Extension of the liquefied gas installation certificate

A similar procedure to (3.2.1) shall be applied, with page 12a inserted after page 12.

3.2.3 Annex to the inland navigation vessel certificate

At the bottom of page 13 the words 'End of the inland navigation vessel certificate' shall be deleted in red, the deleted words 'Continued on page⁵⁵' shall be underlined in red and behind that the page number 13a shall be entered. This amendment shall carry an official stamp. A further page 13 shall be marked as page 13a and inserted after page 13. The provisions of (2.2) and (2.3) apply to page 13a *mutatis mutandis*.

The same procedure shall be applied for any further annexes (pages 13b, 13c, etc.).

⁵⁵ Delete as appropriate.

4. Explanations of individual items

Self-explanatory items are not mentioned below.

2. If applicable, insert terms as per Article 1.01. Other vessel types shall be entered with their commonly accepted designation.
3. When inland navigation vessel certificate is extended the wording “official number” as well as this number shall be deleted, and in case of amendment, the wording “3. unique European vessel identification number” as well as that number shall be entered.
10. In respect of vessels with Union inland navigation certificate allowed to navigate on the Rhine, i.e.
 - a) those which comply fully with requirements of this Standard including the transitional provisions of Chapter 32, and
 - b) those which make no use of the transitional provisions of Chapter 33 or the reductions provided for zone 4,the following is to be added to the indent '- on EU waterways in Zone(s)^(*):
 - a) Rhine or
 - b) zone R.

As a reminder, based on Article 1.04 and Annex O of the Rhine vessel inspection regulations (RVIR), the Central Commission for the Navigation of the Rhine (CCNR) has recognised these Union certificates as being equivalent, thereby entitling the holder to travel on the Swiss section of the Rhine as far as the Mittlere Brücke.

12. When inland navigation vessel certificate is extended the wording “official number” shall be deleted, and in case of amendment, the wording “12. Unique European vessel identification number” as well as that number shall be entered.
15. This section shall only be completed for craft for which at least one of the properties 1.1 or 1.2 or 3 in item 14 is not deleted, otherwise the entire table shall be deleted.
- 15.1 In the column ‘formation figure’ of the table the number(s) of the formations depicted shall be entered. Lines without entry shall be struck through. Further formations may be drawn under ‘Other formations’ and shall be designated 18, 19, 20, etc.

If it is not apparent from the property ‘fit to push’ in the previous ship certificate which formations are authorised, the entry from the previous inland navigation vessel certificate may be transferred to item 52. ‘See item 52’ shall be entered in line 1 of the table ‘Authorised formations’.

- 15.2 Couplings

Only the details of the coupling between the pushing craft and the pushed section of the convoy shall be entered.

- 17-20. Details according to the tonnage certificate items 17-19 to two decimal places and item 20 without decimal places. Length overall and breadth overall give the maximum dimensions of the craft, including all projecting fixed parts. Length L and Breadth B give the maximum hull dimensions (see also Article 1.01 Definitions).
21. Dead weight tonnage for cargo vessels in t according to the measurement certificate for the maximum draught according to item 19.
- Displacement for all other craft in m^3 . If no measurement certificate is available, calculate the displacement from the product of the block coefficient and length L_{WL} , breadth B_{WL} and mean draught at maximum immersion.
23. Number of passenger sleeping berths available.
24. Only watertight transverse bulkheads extending from one side of the vessel to the other shall be taken into consideration.
26. If applicable, the following terms shall be used:
- manually operated hatch covers,
 - manually operated rolling hatch covers,
 - manually operated sliding hatch covers,
 - mechanically operated sliding hatch covers,
 - mechanically operated hatch covers.
- Other types of hatch covers shall be entered with their commonly accepted designation.
- Any holds which do not have a hatch cover shall be listed, e.g. under item 52.
28. Figure without decimal place.
- 30, 31
and 33. Every winch housing shall be counted as one winch, regardless of the number of anchors or towing cables connected to it.
34. Under 'Other installations' systems which do not use rudder blades (e.g. rudder-propeller, cycloidal-propeller, bow-thruster systems) shall be entered.
Enter also any electrical auxiliary engines for manual actuation.
With bow-thruster systems, 'remotely-controlled' refers only to remote controls operated from the steering position in the wheelhouse.
35. Only the theoretical values according to Article 8.08(2) and (3), Article 19.01(1)(c), and Article 19.08(5) shall be entered. For craft whose keels were laid on or before 1.4.1976, the first section is only to be completed in the event of the bilge pumps being replaced and in the event of the inland navigation vessel certificate being extended after 1.1.2015. For craft whose keels were laid down on or before 31.12.1984 and only operated outside zone R, the section can be left void.
36. A sketch may be necessary for clarification.

37. Only the theoretical values without reduction according to Article 13.01(1) to (4) shall be entered.
38. Only the minimum lengths according to Article 13.01(10) and the minimum breaking load according to Article 13.01(11) shall be entered.
39.
and 40. Only the minimum lengths and minimum breaking load values recalculated according to Article 13.02(3) shall be entered.
42. The inspection body may add items to the list of necessary equipment. These shall be justified as essential to ship safety for the respective vessel type or its operational area. Additions shall be entered under item 52.
- Left column, row 3 to 5: for passenger vessels the first mentioned item shall be crossed out and for all other vessels the second mentioned item shall be crossed out. The length of the gangway shall be entered if the inspection body has allowed a shorter length than what is foreseen by Article 13.02(3)(d) or by Article 19.06(12).
- Left column, row 7: here the number of the prescribed first aid kits according to Article 13.02(3)(f) and Article 19.08(9) shall be entered.
- Left column, row 11: here the number of the prescribed fire proof receptacles according to Article 13.02(2) shall be entered.
43. Portable fire extinguishers required by other safety regulations, e.g. and regulation, are not included here.
44. Row 3: in inland navigation vessel certificates to be renewed before 1.1.2025 (Chapter 33), the item 'according to Article 13.08(2)' shall be crossed if no lifejackets according to this Standard are onboard.
- Row 4: in inland navigation vessel certificates to be renewed after 1.1.2015, or if a new dinghy is taken onboard, or for newly-built craft, the item 'with a set of oars, one mooring line and a bailer' shall be crossed. In inland navigation vessel certificates to be renewed after 1.1.2030 (Chapter 33), and if no dinghy according to this Standard is onboard, the item 'according to Standard EN 1914 : 2016' shall be crossed. In the inland navigation vessel certificate to be renewed before 1.9.2036, if compliance to Standard EN 1914 : 1997 is proven, the item '2016' could be crossed.
46. As a general rule, continuous operation shall not be inserted if there is a lack of sleeping berths or if there are excessive noise levels.
50. The expert shall sign only if he has completed page 11 himself.
52. Here any additional restrictions, exemptions and explanations, or similar, applying to entries under individual items can be given.

5. Transitional provisions for Union inland navigation vessel certificates

5.1 Existing Community certificates

With the exception of the exceptional 6 months extension, no further extensions to existing community certificates shall be granted.

5.2 Replacement after a periodical inspection

After a periodical inspection of a vessel which does not yet have a Union inland navigation certificate in line with the model in Annex 3, Section I, a Union inland navigation certificate shall be issued.

ESI-I-2 EXPERTS AND COMPETENT PERSONS

(Article 1.01, 10.3 and 10.4)

Experts

Experts are required to carry out testing which call for specialist knowledge either on account of the complexity of the systems or on account of the safety level required. The following persons or institutions are among those authorised to carry out such testing:

- Classification societies which have the necessary in-house expertise or which bear responsibility, on the basis of their authorisation, for calling in external persons or institutions and have the necessary quality control systems in place in respect of the selection of these persons or institutions;
- Members of the inspection bodies or employees of the relevant authorities;
- Officially approved persons or institutions with recognised expertise for the scope of inspection in the relevant subject area, whereby the vessel inspection bodies can also issue this approval in their capacity as public agencies, ideally on the basis of a quality assurance system. A person or institution is also deemed to be approved if the latter has passed an official selection procedure which specifically assesses the possession of the required expertise and experience.

Traditional craft expert

A person appointed by the competent authority or by an authorised institution of a Member State, who possesses special knowledge in the field of traditional craft due to his or her training and experience in the subject, and who is familiar with the relevant technical requirements and rules, also from the time period of the traditional craft.

Competent persons

Competent persons are required, for example, to conduct regular visual checks and operating checks on safety equipment. The following may be classed as competent persons:

- Persons who, on the basis of their professional training and experience, have sufficient expertise to be able to assess specific situations and circumstances, e.g. ship's masters, safety officers in shipping companies, crew members with relevant experience;
- Companies which have acquired sufficient specialist knowledge on the basis of their regular work, e.g. shipyards or installation firms;
- Manufacturers of special-purpose systems (e.g. fire extinguishing systems, control equipment).

Terminology

German	English	French	Dutch
Sachverständiger	expert	expert	erkend deskundige
Sachkundiger	competent person	spécialiste	deskundige
Fachfirma	competent firm	société spécialisée	deskundig bedrijf

Testing

The table below summarises the schedule of testing, including their frequency and the type of inspector required to conduct them. This table is for information purposes only.

Requirement	Subject matter	Maximum test interval	Inspector
Article 6.03(5)	Hydraulic cylinders, pumps and motors	8 years	Competent firm
Article 6.09(3)	Motor-driven control equipment	3 years	Competent person
Article 7.12(12)	Elevating wheelhouses and their appliances	1 year	Competent person
Article 8.01(2)	Pressure vessels	5 years	Expert
Article 10.11(17)	Lithium-ion accumulators and fire protection		Expert
Article 11.08(2)	Electric vessel propulsion	On every periodical inspection	Expert
Article 13.03(5)	Portable fire extinguishers	2 years	Competent person
Article 13.04(6)(a) to (c)	Permanently installed firefighting systems		Expert
Article 13.04(6)(d)	Permanently installed firefighting systems	2 years	Competent person or competent firm
Article 13.05(9)(b) (aa) to (cc)	Permanently installed firefighting systems		Expert
Article 13.05(9)(b) (dd)	Permanently installed firefighting systems	2 years	Competent person or competent firm
Article 13.07(3)	Inflatable ship's boats	As specified by the manufacturer	
Article 13.08(3)	Lifejackets	As specified by the manufacturer	
Article 14.12(6)	Cranes	10 years	Expert
Article 14.12(7)	Cranes	1 year	Competent person
Article 17.13	Liquefied gas installations	3 years	Expert
Article 19.09(9)	Life-saving equipment	As specified by the manufacturer	
Article 19.10(9)	Insulating resistance, earthing	before expiry of validity of the inland navigation vessel certificate	
Instruction ESI-II-12 section 3.1(a) and (b)	Fire alarm system		Expert
Instruction ESI-II-12 section 3.1 (c)	Fire alarm system	2 years	Expert or competent person
Instruction ESI-III-4 section 8.1 (a) and (b)	Safety guidance systems		Expert
Instruction ESI-III-4 section 8.1 (c)	Safety guidance systems	5 years	Expert or competent person
Instruction ESI-III-5	Gaswarning equipment	As specified by the manufacturer	Expert or competent person

PART II
PROVISIONS REGARDING SHIPBUILDING, FITTING OUT AND
EQUIPMENT

ESI-II-1
MINIMUM HULL THICKNESS OF BARGES

(Article 3.02(1))

During periodical inspections of barges which are exclusively towed, the inspection body may allow minor deviations from Article 3.02(1)(b) with respect to the minimum thickness of the shell plating of the hull. The deviation shall not be more than 10 %, and the minimum hull thickness shall not be less than 3 mm.

The deviations shall be entered in the inland navigation vessel certificate.

Under item 14 of the inland navigation vessel certificate, only property under item 6.2 'Towed as a craft with no motive power of its own' shall apply

Properties under items 1 to 5.3 and 6.1 shall be deleted.

ESI-II-2 INSTALLATION OF DOUBLER PLATES TO THE HULL

(Article 3.02(1) and Article 19.02(1)(d))

1. Purpose of the instruction

These instructions have been drawn up for the sake of clarity in the rules for maintaining the strength of the hull (Article 3.02(1)) and for replacing and repairing hull plating (Article 3.02(1)(c), last sentence and Article 19.02(1)(d)). This instruction is applicable for installation of new doubler plates.

2. Principals

There are two different types of doubler plates:

1. Doubler plates installed during newbuilding or conversion in accordance with good shipbuilding practice,
2. Doubler plates intended to delay wear or renewal of hull plating. Generally, these plates should be avoided or they should be installed only in particular cases.

3. Doubler plates installed during newbuilding or conversion

3.1 Doubler plates installed during newbuilding

Doubler plates installed during newbuilding are mainly in the following places:

- a) Reinforcing plates around openings and penetrations on the hull and deck plating (manholes, passages for pipes, scuppers, etc.),
- b) Plates at the corners of large hatches,
- c) Longitudinal plate strips at sheer strake level,
- d) Plate strips to protect against wear due to abrasion of the hull plating (at bow and stern and possibly on the bilge plating and the side plating at some height above the bottom),
- e) Reinforcing plates at particular points of the structure under special equipment (for example: anchor windlasses, pumps, masts, cranes, winches, anchors, etc.).

3.2 Doubler plates installed as part of a conversion

If these doubler plates are installed as part of a conversion, they can be mounted only on plates which have not yet reached the minimum thickness, after conversion, and have a corrosion allowance of at least 0,7 mm remaining. Otherwise, the plates that are to carry the doubler plates must be renewed beforehand.

In particular, the plate strips for reinforcing the longitudinal hull girder of the vessel in the case of lengthening must extend at least along the length of the cargo section except in case of justification supported by a calculations note.

4. Doubler plates intended to delay wear or renewal of hull plating

4.1 Places, where the installation of doubler plates is permitted

These plates **may be installed** in the following places:

- a) In case of damage (temporary repair – validity as per certificate),
- b) In case of pitting corrosion, eventually with piercing, not affecting the structural strength (ie: below an engine room, in way of wind/water strake), excepted in way of bottom and bilge plates in cargo zones,
- c) In case of surfaces exposed to abrasion, in order to stop wear of hull plates (may be mounted only on plates that have not yet reached the minimum thickness),
- d) On bilge plating, the doubler plating will be, preferably, continuous for at least 70 % of the vessel length. Otherwise, doubler plates will have a minimum length and a minimum distance in between not less than $(2,5 + L/40)$ m or extend at least along the length of three times the frame spacing for vessels with L not more than 45 m. They shall be extended at least along the length of twice the frame spacing forward of and behind the affected zone,
- e) On riveted seams to assure watertightness,
- f) Fore and aft of a vessel's outside cargo zone.

4.2 Places, where the installation of doubler plates is not permitted

These plates **cannot be installed** at the following locations:

- a) On plates the thickness of which is under the minimum allowable thickness,
- b) On holes in plates due to corrosion on elements ensuring the watertightness of vessel,
- c) Over large areas in cargo zone,
- d) To cover transverse overlap weld seams,
- e) On the bottom between fore bulkhead of fore hold and after bulkhead of after hold,
- f) In the cargo area of motor tankers, tank lighters and tank barges for the transport of dangerous goods according to ADN,
- g) Over bunkers containing flammable products except in abrasion areas,
- h) On plates or seams showing buckling or fatigue phenomenon,
- i) On existing doubler plates.

5. Installation of doubler plates

- a) Doubler plates must be installed and welded in accordance with good shipbuilding practice.
- b) Wear plates will have a width ranging between 200 and 300 mm-
- c) Reinforcing plates of the longitudinal hull girder should not be more than 600 mm wide.
- d) The thickness of the doubler plates shall be between 1 and 1,5 times the thickness of the plate on which it is mounted.
- e) Doubler plates fitted to delay the wear or replacement of hull plates have to be replaced, when their thickness is less than 3 mm.

The presence of doubler plates must be stated on the thickness measurements report. When renewing the certificate, vessel areas where doubler plates are installed must be thoroughly examined in order to determine whether they can be kept in this state.

ESI-II-3
MINIMUM PRESCRIBED FORWARD SPEED, STOPPING CAPACITY AND
CAPACITY FOR GOING ASTERN

(Articles 5.06, 5.07 and 5.08
in conjunction with Articles 5.02(1), 5.03(1), 5.04 and 21.06)

1. Minimum prescribed (forward) speed in accordance with Article 5.06

The speed in relation to the water is satisfactory in accordance with Article 5.06(1) when it reaches at least 13 km/h. During tests, the following conditions shall be met in the same way as for the stopping test:

- a) the keel clearance set out in (2.1) shall be complied with;
- b) the measuring, recording, registration and evaluation of test data shall be carried out according to the procedure described in Annex 1.

2. Stopping capacity and capacity for going astern prescribed in accordance with Articles 5.07 and 5.08

2.1 Vessels and convoys are deemed able to stop facing downstream in good time in accordance with Article 5.07(1) when this is proved during a test of stopping in relation to the ground facing downstream at an initial speed in relation to the water of 13 km/h, with a keel clearance equal to at least 20 % of the draught but not less than 0,50 m.

- a) In flowing water (current velocity of 1,5 m/s), stopping in relation to the water shall be demonstrated over a maximum distance measured in relation to the ground of:

550 m for vessels and convoys of:

- length $L > 110\text{ m}$ or
- width $B > 11,45\text{ m}$,

or

480 m for vessels and convoys of:

- length $L \leq 110\text{ m}$ and
- width $B \leq 11,45\text{ m}$.

The stopping manoeuvre is completed on coming to a stop in relation to the ground.

- b) In standing water (current velocity of less than 0,2 m/s), stopping in relation to the water shall be demonstrated over a maximum distance, measured in relation to the ground of:

350 m for vessels and convoys of:

- length $L > 110\text{ m}$ or
- width $B > 11,45\text{ m}$,

or

305 m for vessels and convoys of:

- length $L \leq 110\text{ m}$ and
- width $B \leq 11,45\text{ m}$.

In standing water, a test shall also be performed to demonstrate that a speed of not less than 6,5 km/h can be reached when going astern.

The measuring, recording and registration of the test data referred to in (a) or (b) shall be carried out in accordance with the procedure set out in Annex 1.

Throughout the entire test, the vessel or the convoy shall have adequate manoeuvrability.

- 2.2 In accordance with Article 5.04, during the test, vessels shall be loaded as far as possible to 70 – 100 % of their deadweight. This loading condition shall be evaluated in accordance with Annex 2. When the vessel or the convoy is loaded to less than 70 % at the time of the test, the permitted maximum displacement in downstream navigation shall be set in accordance with the actual load, provided that the limit values of (2.1) are complied with.
- 2.3 If the actual values of the initial speed and current velocity at the time of the test do not meet the conditions set out in (2.1), the results obtained shall be evaluated according to the procedure described in Annex 2.

The permitted deviation of the initial speed of 13 km/h shall be not more than ± 1 km/h, and the current velocity in flowing water shall be between 1,3 and 2,2 m/s, otherwise the tests shall be repeated.

- 2.4 The permitted maximum displacement or the respective maximum load or the maximum immersed cross-section for vessels and convoys in downstream navigation shall be determined on the basis of the tests and entered in the inland navigation vessel certificate.

Annex 1 to instruction ESI-II-3

Measuring, recording and registration of data collected during stopping manoeuvre tests

1. Stopping manoeuvre

The vessels and convoys referred to in Chapter 5 shall carry out a test in flowing water or in standing water, in a test area, to prove that they are capable of stopping facing downstream only with their propulsion system without the use of anchors. The stopping manoeuvre shall, in principle, be carried out in accordance with figure 1. It begins when the vessel is travelling at a constant speed of as near as possible to 13 km/h in relation to the water by reversing the engines from 'ahead' to 'astern' (point *A* of the order 'stop') and is completed when the vessel is stationary in relation to the ground (point *E*: $v = 0$ in relation to the ground or point *D*: $v = 0$ in relation to the water and in relation to the ground if the stopping manoeuvre is carried out in standing water).

When stopping manoeuvres are carried out in flowing water, the position and the moment of stopping in relation to the water shall also be recorded (the vessel moves at the speed of the current; point *D*: $v = 0$ in relation to the water).

The data measured shall be entered in a report as shown in the diagram of table 1. Before the stopping manoeuvre is carried out, the unchanging data shall be entered at the top of the form.

The average current velocity (v_{STR}) in the fairway shall be determined, if available, based on the reading of an established water level gauge, or by measuring the movement of a floating body and shall be entered in the report.

In principle, the use of current metres is permitted to determine the speed of the vessel in relation to the water during the stopping manoeuvre, if it is possible to record the movement and the required data in accordance with the procedure above.

2. Registration of the data measured and recording them in the report (table 1)

For the stopping manoeuvre, first of all the initial speed in relation to the water shall be determined. This can be done by measuring the time taken to travel between two markers on land. In flowing water, the average current velocity shall be taken into account.

The stopping manoeuvre is initiated by the order 'stop' *A*, given on passing a marker on land. Passing the land marker shall be recorded perpendicularly to the axis of the vessel and shall be entered in the report. Passing all other land markers during the stopping manoeuvre shall be similarly recorded and each marker (e.g. kilometre post) and the time of passing shall be noted in the report.

The values measured shall, if possible, be recorded at intervals of 50 m. In each case, note should be taken of the time when points *B* and *C* — if possible — as well as when points *D* and *E* are reached and the respective position shall be estimated. The data concerning the engine speed need not be recorded in the report, but should be noted to permit more accurate control of the initial speed.

3. Description of the stopping manoeuvre

The stopping manoeuvre according to figure 1 shall be presented in the form of a diagram. First of all, the time-traverse diagram shall be plotted using the measurements entered in the test report and points *A* to *E* shall be indicated. It will then be possible to determine the average speed between two measurement points and to plot the speed/time diagram.

This is done as follows (see figure 1):

By determining the quotient of the difference of position over the difference in time $\Delta s/\Delta t$, the average speed of the vessel for this period can be calculated.

During the interval between 0 sec. and 10 sec., the distance from 0 m to 50 m is covered.

$$\Delta s/\Delta t = 50 \text{ m}/10 \text{ s} = 5,0 \text{ m/s} = 18,0 \text{ km/h}$$

This value is entered as the average speed at the 5 sec. abscissa-position.

During the second interval, from 10 sec. to 20 sec., a distance of 45 m is covered.

$$\Delta s/\Delta t = 45 \text{ m}/10 \text{ s} = 4,5 \text{ m/s} = 16,2 \text{ km/h}$$

At marker *D*, the vessel has stopped in relation to the water i.e. current velocity is approximately 5 km/h.

Figure 1: Stopping manoeuvre

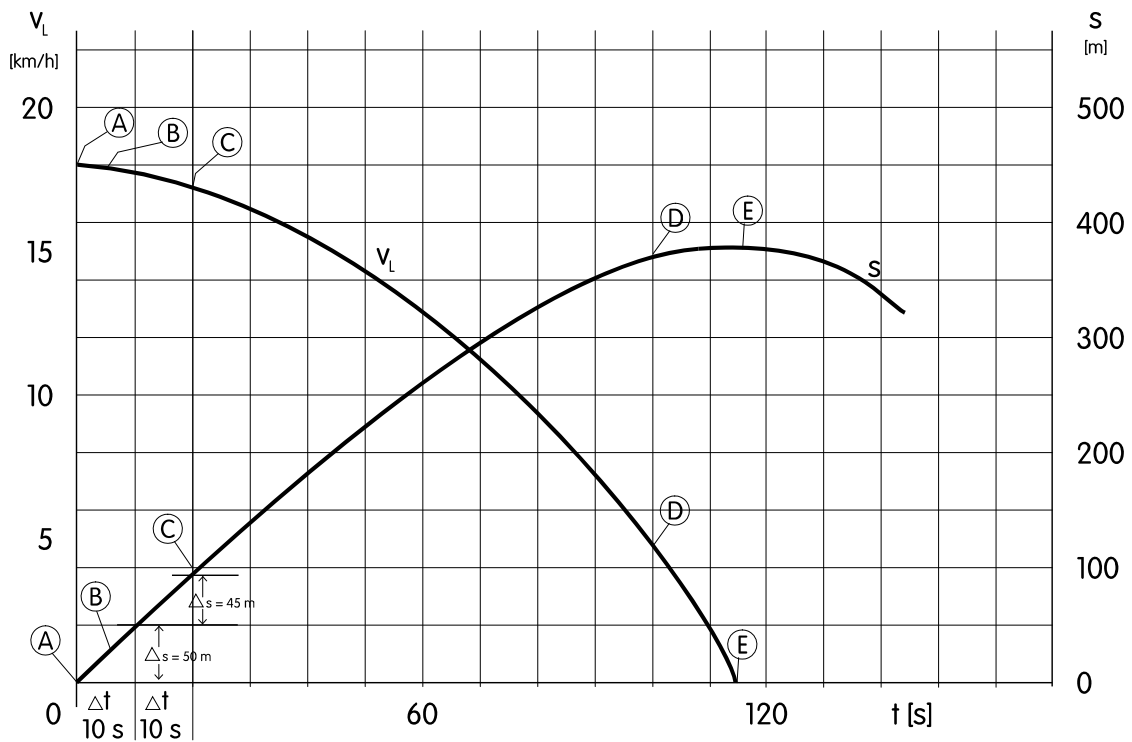

Key to symbols in figure 1

- | | | | |
|----------|-----------------------------------|----------|--|
| <i>A</i> | 'stop' order | <i>v</i> | speed of vessel |
| <i>B</i> | propeller stopped | v_L | v in relation to the ground |
| <i>C</i> | propeller in reverse | <i>s</i> | distance covered in relation to the ground |
| <i>D</i> | $v = 0$ in relation to the water | <i>t</i> | measured time |
| <i>E</i> | $v = 0$ in relation to the ground | | |

Inspection body : Date : Name : Test run No:	Type of vessel or convoy: $L \times B$ [m]: T during test [m]: Load during test [t]: % of maximum deadweight: Power of propulsion engines P_B [kW] Propulsion system according to Annex 2, table 2:	Test area: Water level gauge reading [m]: Water depth [m]: Gradient [m/km]: v_{STR} [km/h]: [m/s]: Max displacement [m ³]:
---	---	--

Table 1: Report of the stopping manoeuvre

POSITION [river-km]	TIME [sec.]	Δs [m]	Δt [sec]	v_L [km/h]	ENGINE SPEED n [min ⁻¹]	OBSERVATIONS

Annex 2 to instruction ESI-II-3

Evaluation of the results of the stopping manoeuvre

1. On the basis of the values recorded compliance with the limit values in accordance with Annex 1 shall be verified. If the conditions for the stopping manoeuvre deviate substantially from the standard conditions, or if there are doubts as to the compliance with the limit values, the results shall be evaluated. To that end the following procedure may be applied for calculating stopping manoeuvres.
2. Theoretical stopping distances are determined under the standard conditions (s_{SOLL}) of (2.1) of this instruction and under stopping manoeuvre conditions (s_{IST}) and are compared with the stopping distance measured ($s_{MESSUNG}$). The corrected stopping distance of the stopping manoeuvre under standard conditions (s_{NORM}) is calculated as follows:

$$\text{Formula (2.1)} \quad s_{NORM} = s_{MESSUNG} \cdot \frac{s_{SOLL}}{s_{IST}} \leq \text{limit value}$$

in accordance with (2.1)(a) or (b) of this instruction.

When the stopping manoeuvre has been carried out with a load of 70 – 100 % of the maximum deadweight in accordance with (2.2) of this instruction in order to calculate s_{NORM} the displacement ($D_{SOLL} = D_{IST}$) corresponding to the load at the time of the test shall be used for the determination of s_{SOLL} and s_{IST} .

When in determining s_{NORM} according to formula (2.1), the limit value in question is exceeded or not reached, the value of s_{SOLL} shall be reduced or increased by variation of D_{SOLL} so that the limit value is complied with ($s_{NORM} = \text{limit value in question}$). The maximum displacement permitted in downstream navigation shall be set accordingly.

3. According to the limit values given in (2.1)(a) and (b) of this instruction, only the stopping distances measured in
 - Phase I ('Full ahead' reversed to 'full astern'): s_I
 - and
 - Phase II (End of reversal until vessel stops in relation to the water): s_{II}

shall be calculated (see figure 1). The total stopping distance is then:

$$\text{Formula (3.1)} \quad s_{GES} = s_I + s_{II}$$

4. The particular stopping distances shall be calculated as follows:

Calculation of the stopping manoeuvre

Figure 2: Diagram

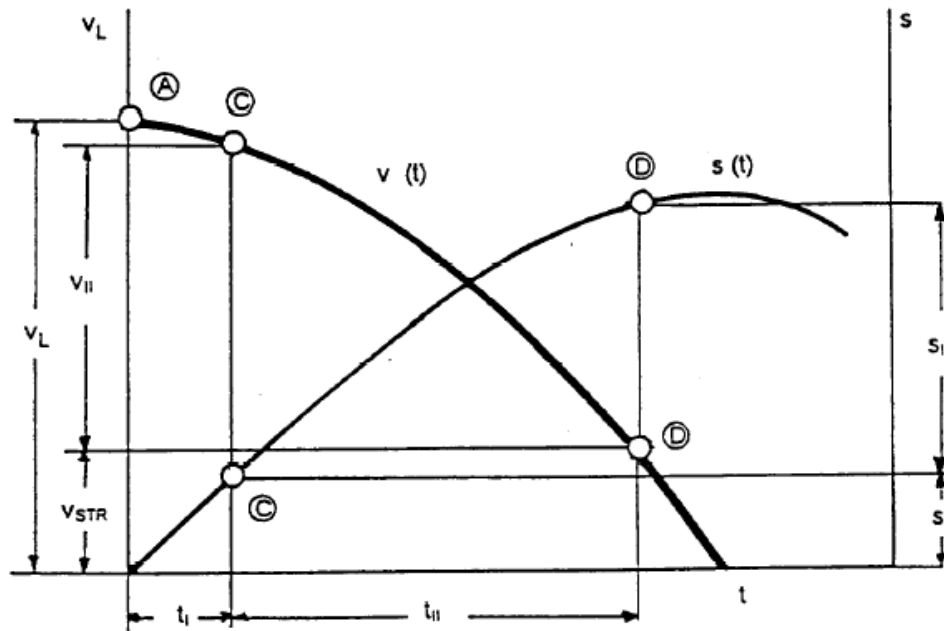

Calculation Formulae:

4.1 $S_I = k_1 \cdot v_L \cdot t_I \quad t_I \leq 20 \text{ s}$

4.2 $S_{II} = k_2 \cdot v_{II}^2 \cdot \frac{D \cdot g}{k_3 \cdot F_{POR} + R_{TMII} - R_G} \cdot \left(k_4 + \frac{v_{STR}}{v_{II}}\right)$

4.3 $R_{TMII} = \left(\frac{R_T}{v^2}\right) \cdot (k_7 \cdot k_6 \cdot (v_L - v_{STR}))^2$

4.4 $R_G = i \cdot D \cdot \rho \cdot g \cdot 10^{-6}$

4.5 $v_{II} = k_6 \cdot (v_L - v_{STR})$

4.6 $F_{POR} = f \cdot P_B$

4.7 $t_{II} = \frac{s_{II}}{v_{II} \cdot \left(k_4 + \frac{v_{STR}}{v_{II}}\right)}$

with the following coefficients

- k_1 according to table 1
- k_2, k_3, k_4 according to table 1
- k_6, k_7 according to table 1
- R_T/v^2 according to table 3
- k_6 according to table 1
- f according to table 2
- k_4 according to table 1

In formulae 4.1 to 4.7:

v_L	Speed in relation to the ground at the start of reversal	(m/s)
t_I	Reversal time	(s)
v_{II}	Speed in relation to the water at the end of reversal	(m/s)
D	Displacement	(m ³)
F_{POR}	Bollard pull in reverse	(kN)
P_B	Power of propulsion engine	(kW)
R_{TmII}	Average resistance during phase II	(kN)
R_G	Gradient resistance	(kN)
i	Gradient in m/km (if missing to be taken as 0,16)	(m/km)
v_{STR}	Average current velocity	(m/s)
g	Acceleration due to gravity (9,81)	(m/s ²)
ρ	Density of water, ρ fresh water = 1000	(kg/m ³)
T	Maximum draught (of vessel or convoy)	(m)
h	Water depth	(m)
B	Width	(m)
L	Length	(m)

The coefficients for the formulae (4.1), (4.2), (4.3), (4.4), (4.5), (4.6) and (4.7) can be taken from the tables below.

Table 1: k factors for:

- a) MOTOR CARGO VESSELS, MOTOR TANKERS and single file CONVOYS,
- b) Two-abreast CONVOYS,
- c) Three-abreast CONVOYS.

	a)	b)	c)	Units
k_1	0,95	0,95	0,95	-
k_2	0,115	0,120	0,125	$\frac{k_g \cdot s^2}{m^4}$
k_3	1,20	1,15	1,10	-
k_4	0,48	0,48	0,48	-
k_6	0,90	0,85	0,80	-
k_7	0,58	0,55	0,52	-

Table 2: Coefficient f for ratio between bollard pull in reverse and the power of the propulsion engines

Propulsion system	f	Units
Modern nozzles with rounded rear edge	0,118	kN/kW
Old nozzles with sharp rear edge	0,112	kN/kW
Propellers without nozzle	0,096	kN/kW
Rudder propellers with nozzles (generally sharp rear edge)	0,157	kN/kW
Rudder propellers without nozzles	0,113	kN/kW

Table 3: Diagram concerning the calculation of resistance to determine the value of R_T/v^2 in relation to $D^{1/3} [B + 2T]$:

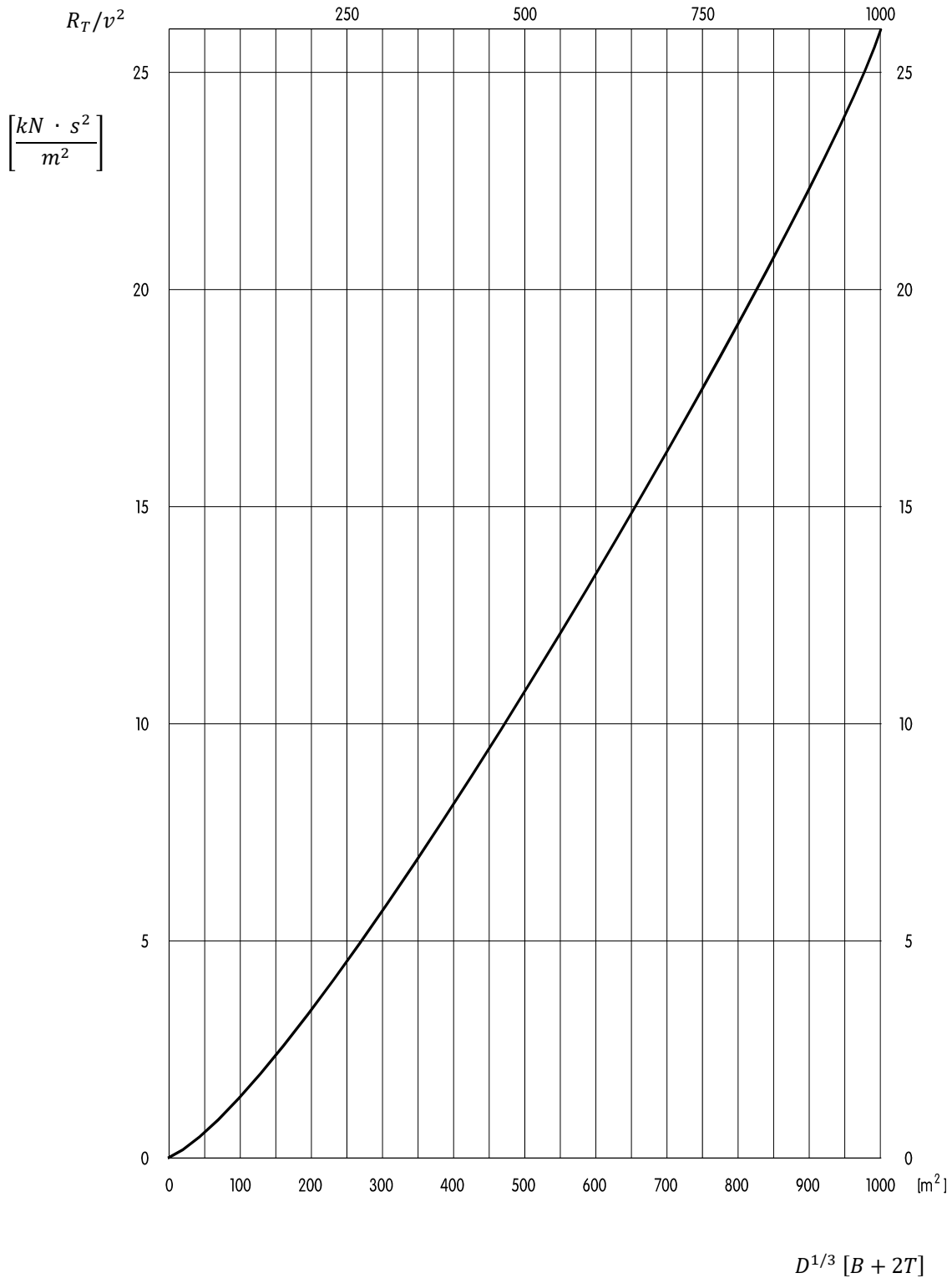

Appendix to Annex 2 to instruction ESI-II-3
Examples on the application of Annex 2
(Evaluation of the results of the stopping manoeuvre)

Example I

1. Data of vessels and convoy

Formation: motor cargo vessel with a (Europa IIa) lighter coupled abreast

	L [m]	B [m]	T_{max} [m]	Tgf^*_{max} [t]	D_{max} [m ³]	P_B [kW]
Motor cargo vessel	110	11,4	3,5	2900	3731	1500
Lighter	76,5	11,4	3,7	2600	2743	-
Convoy	110	22,8	3,7	5500	6474	1500

Propulsion system of the motor cargo vessel: modern nozzles with rounded rear edge

* Tgf = deadweight.

2. Values measured during the stopping manoeuvre

Current velocity: v_{STRIST} = 1,4 m/s \approx 5,1 km/h

Speed of vessel (in relation to the water): v_{SIST} = 3,5 m/s \approx 12,5 km/h

Speed of vessel (in relation to the ground): v_{LIST} = 4,9 m/s \approx 17,6 km/h

Reversal time (measured) (point A to C): t_I = 16 s

Stopping distance in relation to the water (point A to D): $s_{MESSUNG}$ = 340 m

Loading condition (possibly estimated): D_{IST} = 5179 m³ \approx 0,8 D_{max}

Actual draught of convoy: T_{IST} = 2,96 m \approx 0,8 T_{max}

3. Limit value according to (2.1)(a) or (b) to be compared with s_{NORM}

Since $B > 11,45 \text{ m}$ and since the convoy is in flowing water, the following is applicable for this convoy under (2.1)(a):

$$s_{NORM} \leq 550 \text{ m}$$

4. Determination of corrected stopping distance compared to standard conditions

- **Measured** value according to Annex 1 (see (2)):

$$s_{MESSUNG} = 340 \text{ m}$$

- **to be calculated:**

s_{IST} as the sum of

$s_{I_{IST}}$ (according to formula (4.1) of Annex 2 with $v_{L_{IST}}$)

and $s_{II_{IST}}$ (according to formulae (4.2), (4.3), (4.4), (4.5) and (4.6) of Annex 2 with actual speeds $v_{II_{IST}}$, $v_{STR_{IST}}$, D_{IST})

s_{SOLL} as the sum of

$s_{I_{SOLL}}$ (according to formula (4.1) of Annex 2 with $v_{L_{SOLL}}$)

$s_{II_{SOLL}}$ (according to formulae (4.2) to (4.6) of Annex 2 with the reference speeds according to (2.1) of the instruction and given that the loading condition is greater than 70 % of the maximum load ($\approx 80 \%$): $D_{SOLL} = D_{IST}$ and $T_{SOLL} = T_{IST}$)

- **to be checked:**

$$s_{NORM} = s_{MESSUNG} \cdot \frac{s_{SOLL}}{s_{IST}} \leq 550 \text{ m}$$

4.1 Coefficients for the calculation taken from Annex 2

Table 1

$$\text{for } s_{IIST} \text{ and } s_{ISOLL} \quad k_1 = 0,95$$

for s_{IIIST} and s_{IISOLL}

$$k_2 = 0,12$$

$$k_3 = 1,15$$

$$k_4 = 0,48$$

$$k_6 = 0,85$$

$$k_7 = 0,55$$

Table 2 (for modern nozzles with rounded rear edge)

$$f = 0,118$$

4.2 Calculation of s_{IST}

- a) s_{IIST} with the values measured during the stopping manoeuvre (formula (4.1))

$$s_{IIST} = k_1 \cdot v_{LIST} \cdot t_{IIST}$$

$$s_{IIST} = 0,95 \cdot 4,9 \cdot 16 = 74,5 \text{ m}$$

- b) Formula for s_{IIIST}

$$s_{IIIST} = k_2 \cdot v_{IIIST}^2 \cdot \frac{D_{IST} \cdot g}{k_3 \cdot F_{POR} + R_{TmIIIST} - R_G} \cdot \left(k_4 + \frac{v_{STRIST}}{v_{IIIST}} \right)$$

- c) Calculation of $R_{TmIIIST}$ according to table 3 and formula (4.3) of Annex 2

$$D_{IST}^{1/3} = 5179^{1/3} = 17,3 \text{ [m]}$$

$$D_{IST}^{1/3} \cdot (B + 2 \cdot T_{IST}) = 17,3 \cdot (22,8 + 5,92) = 496,8 \text{ [m}^2\text{]}$$

according to table 3 $\frac{R_T}{v^2} = 10,8 \left(\frac{\text{kN} \cdot \text{s}^2}{\text{m}^2} \right)$

$$v_{LIST} - v_{STRIST} = 4,9 - 1,4 = 3,5 \text{ m/s}$$

$$R_{TmIIIST} = \frac{R_T}{v^2} \cdot \left(k_7 \cdot k_6 \cdot (v_{LIST} - v_{STRIST}) \right)^2 = 10,8 \cdot (0,55 \cdot 0,85 \cdot 3,5)^2 = \mathbf{28,8 \text{ [kN]}}$$

- d) Calculation of resistance to gradient R_G according to formula (4.4)

$$R_G = 10^{-6} \cdot (0,16 \cdot D_{IST} \cdot \rho \cdot g) = 10^{-6} \cdot (0,16 \cdot 5179 \cdot 1000 \cdot 9,81) = \mathbf{8,13 \text{ [kN]}}$$

- e) Calculation of v_{IIIST} according to formula (4.5)

$$v_{IIIST} = k_6 \cdot (v_{L_{IST}} - v_{STR_{IST}}) = (0,85 \cdot 3,5) = 2,97 \text{ [m/s]}$$

$$v^2_{IIIST} = 8,85 \text{ [m/s]}^2$$

- f) Calculation of F_{POR} according to formula (4.6) and table 2

$$F_{POR} = 0,118 \cdot 1500 = \mathbf{177 \text{ [kN]}}$$

- g) Calculation of s_{IIIST} using formula (b) and the results of (c), (d), (e) and (f)

$$s_{IIIST} = \frac{0,12 \cdot 8,85 \cdot 9,81 \cdot \left(0,48 + \frac{1,4}{2,97}\right)}{1,15 \cdot 177 + 28,8 - 8,13} \cdot 5179$$

$$s_{IIIST} = \mathbf{228,9 \text{ m}}$$

- h) Calculation of total distance according to formula (3.1)

$$s_{IIST} = 74,51 + 228,9 = \mathbf{303,4 \text{ m}}$$

Annotation

Note: The term $(R_{T_{mII}} - R_G)$, which is a function of D , with an actual value of 20,67 kN is obviously relatively small compared to $k_3 \cdot F_{POR}$ with an actual value of 203,55 kN, so for simplification purposes, s_{II} can be taken as proportional to D , i.e. $s_{II} = Const \cdot D$.

4.3 Calculation of s_{SOLL}

Initial values:

$$v_{STR_{SOLL}} = 1,5 \text{ m/s} \approx 5,4 \text{ km/h}$$

$$D_{SOLL} = D_{IST} = 5179 \text{ m}^3$$

$$v_{SOLL} = 3,6 \text{ m/s} \approx 13 \text{ km/h}$$

$$T_{SOLL} = T_{IST} = 2,96 \text{ m}$$

$$v_{L_{SOLL}} = 5,1 \text{ m/s} \approx 18,4 \text{ km/h}$$

a) $s_{I_{SOLL}} = k_1 \cdot v_{L_{SOLL}} \cdot t_I$

$$s_{I_{SOLL}} = 0,95 \cdot 5,1 \cdot 16 = \mathbf{77,50 \text{ m}}$$

b) $s_{II_{SOLL}} = k_2 \cdot v_{II_{SOLL}}^2 \cdot \frac{D_{SOLL} \cdot g}{k_3 \cdot F_{POR} + R_{T_{mII_{SOLL}}} - R_G} \cdot \left(k_4 + \frac{v_{STR_{SOLL}}}{v_{II_{SOLL}}} \right)$

c) Calculation of $R_{T_{mII_{SOLL}}}$

$$\frac{R_T}{v^2} = 10,8 \left(\frac{\text{kN} \cdot \text{s}^2}{\text{m}^2} \right) \quad \text{as in (4.2), since } B, D \text{ and } T \text{ are unchanged}$$

$$v_{L_{SOLL}} - v_{STR_{SOLL}} = 3,6 \text{ [m/s]}$$

$$R_{T_{mII_{SOLL}}} = \frac{R_T}{v^2} \cdot \left(k_7 \cdot k_6 \cdot (v_{L_{SOLL}} - v_{STR_{SOLL}}) \right)^2 = 10,8 \cdot (0,55 \cdot 0,85 \cdot 3,6)^2 = \mathbf{30,99 \text{ [kN]}}$$

d) Resistance due to gradient R_G as in (4.2)

e) Calculation of $v_{II_{SOLL}}$

$$v_{II_{SOLL}} = k_6 \cdot (v_{L_{SOLL}} - v_{STR_{SOLL}}) = 0,85 \cdot 3,6 = \mathbf{3,06 \text{ [m/s]}}, \quad v_{II_{SOLL}}^2 = 9,36 \text{ [m/s]}^2$$

f) F_{POR} comme sous 4.2.

- g) Calculation of $s_{II_{SOLL}}$ using formula (b) and the result from (c) to (f)

$$s_{II_{SOLL}} = \frac{0,12 \cdot 9,36 \cdot 9,81 \cdot \left(0,48 + \frac{1,5}{3,06}\right)}{1,15 \cdot 177 + 30,99 - 8,13} \cdot 5179$$

$$= \underbrace{0,0472}_{Const_{SOLL}} \cdot 5179 = 244,5 \text{ m}$$

- h) Calculation of total distance

$$s_{SOLL} = s_{I_{SOLL}} + s_{II_{SOLL}} = 77,5 + 244,5 = 322 \text{ m}$$

4.4 Verification of compliance with permissible stopping distance under standard conditions

s_{NORM}

according to formula (2.1) of Annex 2

$$s_{NORM} = s_{MESSUNG} \cdot \frac{s_{SOLL}}{s_{IST}} = 340 \cdot \frac{322}{303,4} = 360,8 \text{ m} < 550 \text{ m}$$

Conclusion:

The permissible limit value is far from being reached, i.e.:

- admission to downstream navigation is possible without problems for the actual loading condition ($0,8 \cdot D_{max}$),
- a higher loading condition is possible and may be calculated according to (5) below.

5. Possible increase of D_{IST} in downstream navigation

$$(s_{NORM})_{Limite} = s_{MESSUNG} \cdot \frac{(s_{SOLL})_{Limite}}{s_{IST}} = 550 \text{ m}$$

$$(s_{SOLL})_{Limite} = 550 \cdot \frac{s_{IST}}{s_{MESSUNG}} = 550 \cdot \frac{303,4}{340} = 490,8 \text{ m}$$

Avec $s_{ISOLL} = Const_{SOLL} \cdot D$ according to the note under (4.2):

$$(s_{SOLL})_{Limite} = (s_{ISOLL} + s_{ISOLL})_{Limite} = s_{ISOLL} + 0,0472 \cdot (D_{SOLL})_{Limite}$$

Hence

$$(D_{SOLL})_{Limite} = \frac{(s_{SOLL})_{Limite} - s_{ISOLL}}{0,0472} = \frac{490,8 - 77,5}{0,0472} = 8756 \text{ m}^3$$

From this follows that:

Since $(D_{SOLL})_{Limite} > D_{max}$ ($8756 > 6474$) this formation (see (1)) may be permitted in downstream navigation with full load.

Example II

1. Data of vessels and convoy

Formation: motor cargo vessel propelling
2 lighters side-by-side in front and
1 lighter coupled side-by-side.

	L [m]	B [m]	T_{max} [m]	Tgf^*_{max} [t]	D_{max} [m ³]	P_B [kW]
Motor cargo vessel propelling	110	11,4	3,5	2900	3731	1500
Each lighter	76,5	11,4	3,7	2600	2743	-
Convoy	186,5	22,8	3,7	10700	11960	1500

Propulsion system of the self-propelled motor cargo vessel: modern nozzles with rounded rear edge.

* Tgf = deadweight

2. Values measured during the stopping manoeuvre

Current velocity: $v_{STRIST} = 1,4 \text{ m/s} \approx 5,1 \text{ km/h}$

Speed of vessel (in relation to the water): $v_{SIST} = 3,5 \text{ m/s} \approx 12,5 \text{ km/h}$

Speed of vessel (in relation to the bank): $v_{LIST} = 4,9 \text{ m/s} \approx 17,6 \text{ km/h}$

Reversal time (measured) (point A à C): $t_I = 16 \text{ s}$

Stopping distance in relation to the water (point A to D): $s_{MESSUNG} = 580 \text{ m}$

Loading condition (possibly estimated): $D_{IST} = 9568 \text{ m}^3 \approx 0,8 D_{max}$

Actual draught of convoy: $T_{IST} = 2,96 \text{ m} \approx 0,8 T_{max}$

3. Limit value according to (2.1)(a) or (b) of the instruction to be compared with s_{NORM}

Since $B > 11,45 \text{ m}$ and the convoy is in flowing water, the following applies for this convoy under (2.1)(a):

$$s_{NORM} \leq 550 \text{ m}$$

4. Determination of the corrected stopping distance compared with standard conditions

- **Measured value:**

$$s_{MESSUNG} = 580 \text{ m}$$

- **calculations to be made:**

s_{IST} as the sum of

s_{IIST} (according to formula (4.1) of Annex 2 with $v_{L_{IST}}$)

and s_{IIIST} (according to formulae (4.2), (4.3), (4.4), (4.5) and (4.6) of Annex 2 with real speeds $v_{L_{IST}}$), (see under 2 above) and D_{IST}).

s_{SOLL} : sum $s_{ISOLL} + s_{IISOLL}$ (according to formulae (4.1) to (4.6) of Annex 2 with reference speeds and in conformity of Annex 2, because the loading condition > 70 % of maximum, where $D_{SOLL} = D_{IST}$ and $T_{SOLL} = T_{IST}$)

- **to be verified:**

$$s_{NORM} = s_{MESSUNG} \cdot \frac{s_{SOLL}}{s_{IST}} \leq 550 \text{ m otherwise}$$

- **calculate:**

$$s_{NORM}^* = 550 \text{ m by reduction of } D_{IST} \text{ to } D^*.$$

4.1 Coefficients for the calculation according to Annex 2

Table 1

$$\text{for } s_{IIST} \text{ and } s_{ISOLL} \quad k_1 = 0,95$$

$$\text{for } s_{IIIST} \text{ and } s_{IISOLL}$$

$$k_2 = 0,12$$

$$k_3 = 1,15$$

$$k_4 = 0,48$$

$$k_6 = 0,85$$

$$k_7 = 0,55$$

Table 2 (for modern nozzles with rounded rear edge)

$$f = 0,118$$

4.2 Calculation of s_{IST}

- a) s_{IIIST} Using the values measured during the stopping manoeuvres

$$s_{IST} = k_1 \cdot v_{LIST} \cdot t_{IST}$$

$$s_{IST} = 0,95 \cdot 4,8 \cdot 16 = 73 \text{ m}$$

- b) formula for s_{IIIST}

$$s_{IIIST} = k_2 \cdot v_{IIIST}^2 \cdot \frac{D_{IST} \cdot g}{k_3 \cdot F_{POR} + R_{TmIIIST} - R_G} \cdot \left(k_4 + \frac{v_{STRIST}}{v_{IIIST}} \right)$$

- c) Calculation of $R_{TmIIIST}$ according to table 3 and formula (4.3) of Annex 2

$$D_{IST}^{1/3} = 9568^{1/3} = 21,2 \text{ [m]}$$

$$D_{IST}^{1/3} \cdot (B + 2 \cdot T_{IST}) = 21,2 \cdot (22,8 + 5,92) = 609 \text{ [m}^2\text{]}$$

from table 3 $\frac{R_T}{v^2} = 14 \left(\frac{\text{kN} \cdot \text{s}^2}{\text{m}^2} \right)$

$$v_{LIST} - v_{STRIST} = 4,8 - 1,4 = 3,4 \text{ m/s}$$

$$R_{TmIIIST} = \frac{R_T}{v^2} \cdot \left(k_7 \cdot k_6 \cdot (v_{LIST} - v_{STRIST}) \right)^2 = 14 \cdot (0,55 \cdot 0,85 \cdot 3,4)^2 = \mathbf{35,4 \text{ [kN]}}$$

- d) Calculation of resistance due to gradient R_G according to formula (4.4) of Annex 2

$$R_G = 10^{-6} \cdot (0,16 \cdot D_{IST} \cdot \rho \cdot g) = 10^{-6} \cdot (0,16 \cdot 9568 \cdot 1000 \cdot 9,81) = \mathbf{15,02 \text{ [kN]}}$$

- e) Calculation of v_{IIIST} according to formula (4.5) of Annex 2

$$v_{IIIST} = k_6 \cdot (v_{LIST} - v_{STRIST}) = 2,89 \text{ [m/s]}$$

$$v_{IIIST}^2 = 8,35 \text{ [m/s]}^2$$

- f) Calculation of F_{POR} according to formula (4.6) and table 2

$$F_{POR} = 0,118 \cdot 1500 = \mathbf{177 [kN]}$$

- g) Calculation of s_{IIIST} using formula (b) and the result of (c), (d), (e) and (f)

$$s_{IIIST} = \frac{0,12 \cdot 8,35 \cdot 9,81 \cdot \left(0,48 + \frac{1,4}{2,89}\right)}{1,15 \cdot 177 + 35,4 - 15,02} \cdot 9568$$

$$s_{IIIST} = \mathbf{402 m}$$

- h) Calculation of the total distance according to formula (3.1)

$$s_{IIST} = 73 + 402 = \mathbf{475 m}$$

4.3 Calculation of s_{SOLL}

Initial values:

$$v_{STRSOLL} = 1,5 \text{ m/s} \approx 5,4 \text{ km/h}$$

$$D_{SOLL} = D_{IST} = 9568 \text{ m}^3$$

$$v_{SOLL} = 3,6 \text{ m/s} \approx 13 \text{ km/h}$$

$$T_{SOLL} = T_{IST} = 2,96 \text{ m}$$

$$v_{LSOLL} = 5,1 \text{ m/s} \approx 18,4 \text{ km/h}$$

a) $s_{ISOLL} = k_1 \cdot v_{LSOLL} \cdot t_I$

$$s_{ISOLL} = 0,95 \cdot 5,1 \cdot 16 = \mathbf{77,50 m}$$

b) $s_{IISOLL} = k_2 \cdot v_{IISOLL}^2 \cdot \frac{D_{SOLL} \cdot g}{k_3 \cdot F_{POR} + R_{TmIISOLL} - R_G} \cdot \left(k_4 + \frac{v_{STRSOLL}}{v_{IISOLL}}\right)$

- c) Calculation of
- $R_{TmII_{SOLL}}$

$$\frac{R_T}{v^2} = 14,0 \left(\frac{kN \cdot s^2}{m^2} \right) \quad \text{as under (4.2) since } B, D \text{ and } T \text{ are unchanged}$$

$$v_{LSOLL} - v_{STR_{SOLL}} = 3,6 [m/s]$$

$$R_{TmII_{SOLL}} = 14,0 \cdot (0,55 \cdot 0,85 \cdot 3,6)^2 = \mathbf{39,6 [kN]}$$

- d) Resistance due to gradient
- R_G
- as under (4.2)

- e) Calculation of
- $v_{II_{SOLL}}$

$$v_{II_{SOLL}} = 0,85 \cdot 3,6 = \mathbf{3,06 [m/s]}, \quad v^2_{II_{SOLL}} = 9,36 [m/s]^2$$

- f)
- F_{POR}
- as under (4.2)

- g) Calculation of
- $s_{II_{SOLL}}$
- using formula (b) and the result of (c) to (f)

$$s_{II_{SOLL}} = \frac{0,12 \cdot 9,36 \cdot 9,81 \cdot \left(0,48 + \frac{1,5}{3,06} \right)}{1,15 \cdot 177 + 39,6 - 15,02} \cdot 9568$$

$$= \underbrace{0,04684}_{Const_{SOLL}} \cdot 9568 = \mathbf{448 m}$$

$Const_{SOLL}$

- h) Calculation of the total distance

$$s_{SOLL} = s_{I_{SOLL}} + s_{II_{SOLL}} = 77,5 + 448 = \mathbf{525,5 m}$$

4.4 Verification of compliance with permissible stopping distance under standard conditions

s_{NORM}

according to formula (2.1) of Annex 2

$$s_{NORM} = s_{MESSUNG} \cdot \frac{s_{SOLL}}{s_{IST}} = 580 \cdot \frac{525,5}{475} = \mathbf{641 m} > \mathbf{550 m}$$

Conclusion:

The limit value has clearly been exceeded; admission to downstream navigation is possible only with a load restriction. This restricted load can be determined in conformity with (5) below.

5. D^* permissible in downstream navigation

according to formula (2.1) of Annex 2

$$s_{NORM} = s_{MESSUNG} \cdot \frac{s_{SOLL}^*}{s_{IST}} = 550 \text{ m}$$

Therefore:

$$s_{SOLL}^* = 550 \cdot \frac{s_{IST}}{s_{MESSUNG}} = s_{ISOLL} + s_{IISOLL}^*$$

$$s_{IISOLL}^* = Const_{SOLL} \cdot D^* = 0,04684 \cdot D^*$$

$$D^* = \frac{550 \cdot \frac{475}{580} - 77,5}{0,04684} = 7950 \text{ [m}^3\text{]}$$

Consequence:

Since in downstream navigation the permissible displacement D^* is only 7950 m³ (approximately)

$$\frac{zul. Tgf}{max. Tgf} = \frac{D^*}{D_{max}} = \frac{7950}{11960} = 0,66$$

The permissible deadweight in this formation is (see (1)):

$$0,66 \cdot 10700 = \mathbf{7112 \text{ t}}$$

ESI-II-4

CAPACITY FOR TAKING EVASIVE ACTION AND TURNING CAPACITY

(Articles 5.09 and 5.10 in conjunction with Articles 5.02(1), 5.03(1), 5.04 and 21.06)

1. General conditions and boundary conditions relating to the evasive action test

- 1.1 According to Article 5.09, vessels and convoys shall be able to take evasive action in good time and the capacity for such action shall be proved by evasive action manoeuvres in the test area in accordance with Article 5.03. This shall be proved by simulated evasive action manoeuvres to port and starboard with prescribed values whereby for specific turning speeds of the vessel in response to putting across and then checking the helm a certain time limit shall be complied with.

During tests the requirements of Section 2 shall be complied with keeping a keel clearance of at least 20 % of the draught, but not less than 0,50 m.

2. Evasive action test procedure and recording of data (Diagram in Annex 1)

- 2.1 Evasive action manoeuvres shall be performed as follows:

With the vessel or convoy under way at a constant speed of $V_0 = 13$ km/h in relation to the water, at the start of the manoeuvre (time $t_0 = 0$ s, turning speed $r = 0^\circ/\text{min}$, rudder angle $\delta_0 = 0^\circ$, engine speed kept constant), evasive action to port or starboard is to be initiated by putting across the helm. The rudder shall be set to an angle δ , or the steering unit to an angle δ_a in the case of an active steering device, at the start of the manoeuvre, in accordance with the indications given in (2.3). The rudder angle δ (e.g. 20° to starboard) shall be maintained until the value r_1 of the turning speed referred to in (2.2) for the corresponding dimensions of the vessel or convoy is reached. When the turning speed r_1 is reached, the time t_1 shall be recorded and the rudder set to the same angle on the opposite side (e.g. 20° to port) so as to stop the turn and commence turning in the opposite direction, i.e., to reduce the turning speed to $r_2 = 0$ and let it to rise again to the value given in (2.2). When the turning speed $r_2 = 0$ is reached, the time t_2 shall be recorded. When the turning speed r_3 given in (2.2) is reached, the rudder shall be set in the opposite direction to the same angle δ , so as to stop the turning movement. The time t_3 shall be recorded. When the turning speed $r_4 = 0$ is reached, the time t_4 shall be recorded and the vessel or convoy shall be returned to its original course.

2.2 The following limit values shall be complied with to reach turning speed r_4 depending on the dimensions of the vessels or the convoys and on the water depth h :

	Dimensions of vessels or convoys $L \times B$ [m]	Required turning speed $r_1 = r_3$ [°/min]		Limit values for the time t_4 (s) in shallow and deep water		
		$\delta = 20^\circ$	$\delta = 45^\circ$	$1,2 \leq h/T \leq 1,4$	$1,4 < h/T \leq 2$	$h/T > 2$
1	All motor cargo vessels, motor tankers, passenger vessels and motorised floating equipment; single-in-line convoys $\leq 110 \times 11,45$	20°/min	28°/min	150 s	110 s	110 s
2	Single-in-line convoys up to $193 \times 11,45$ or two-abreast convoys up to $110 \times 22,90$	12°/min	18°/min	180 s	130 s	110 s
3	Two-abreast convoys $\leq 193 \times 22,90$	8°/min	12°/min	180 s	130 s	110 s
4	Two-abreast convoys up to $270 \times 22,90$ or three-abreast convoys up to $193 \times 34,35$	6°/min	8°/min	*)	*)	*)

*) In accordance with the decision of the nautical expert.

The times t_1 , t_2 , t_3 and t_4 required to reach turning speeds r_1 , r_2 , r_3 and r_4 shall be recorded in the measurements report in Annex 2. The t_4 values shall not exceed the limits given in the table.

2.3 At least four evasive action manoeuvres shall be carried out, namely:

- one to starboard with a rudder angle $\delta = 20^\circ$
- one to port with a rudder angle $\delta = 20^\circ$
- one to starboard with a rudder angle $\delta = 45^\circ$
- one to port with a rudder angle $\delta = 45^\circ$.

If necessary (e.g. in the case of uncertainty about the values measured or of unsatisfactory manoeuvres), the evasive action manoeuvres shall be repeated. The turning speeds given in (2.2) and the time limits shall be complied with. For active steering devices or special types of rudder, a position δ_a of the steering unit or rudder angle δ_a other than $\delta = 20^\circ$ and $\delta = 45^\circ$ may be selected, according to the expert's assessment, depending on the type of steering system.

2.4 In order to determine the turning speed, a rate-of-turn indicator in accordance with Article 7.06(1) shall be on board.

2.5 In accordance with Article 5.04, the loading condition during the evasive action manoeuvre shall be between 70 % and 100 % of the maximum deadweight. If the test is carried out with a smaller load, approval for downstream and upstream navigation shall be restricted to that load limit.

The procedure for evasive action manoeuvres and the terms used are shown in a diagram in Annex 1.

3. Turning capacity

The turning capacity of vessels and convoys whose length (L) does not exceed 86 m and width (B) does not exceed 22,90 m shall be considered sufficient under Article 5.10, in conjunction with Article 5.02(1) when during an upstream turning manoeuvre with an initial speed in relation to the water of 13 km/h, the limit values for stopping facing downstream established in instruction ESI-II-3 are complied with. The keel clearance conditions according to Section 1.1 shall be complied with.

4. Other requirements

4.1 Notwithstanding (1) to (3), the following requirements shall be met:

- a) for manually controlled steering systems, a single turn of the wheel shall correspond to a rudder angle of at least 3°;
- b) for powered steering systems, when the rudder is at maximum immersion, it shall be possible to achieve an average angular velocity of 4°/s over the rudder's entire turning range.

This requirement shall also be checked, with the vessel at full speed, for moving the rudder over a range from 35° port to 35° starboard. In addition, it shall be checked whether the rudder keeps the position of maximum angle at maximum propulsion power. For active steering systems or special types of rudder, this provision applies mutatis mutandis.

4.2 If any of the additional equipment referred to in Article 5.05 is needed in order to reach the required manoeuvring capacities, it shall comply with the requirements of Chapter 6, and the following particulars shall be entered under item 52 of the inland navigation vessel certificate:

'Flanking rudders^{*)}/ bow steering systems^{*)}/ other equipment* referred to under item 34 is*/are* necessary to comply with the manoeuvrability requirements of Chapter 5.'

5. Recording of data and reports

The measurements, reports and recording of data shall be carried out according to the procedure set out in Annex 2.

^{*)} Delete as appropriate

Annex 1 to instruction ESI-II-4
Diagram of the evasive action manoeuvre

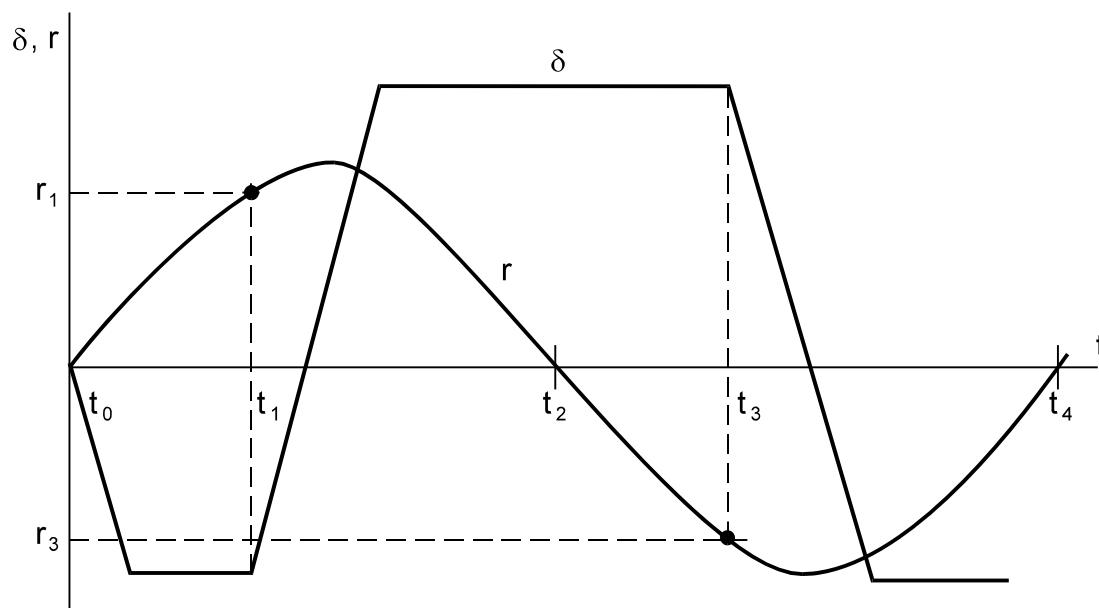

- t_0 = Start of evasive action manoeuvre
- t_1 = Time to reach turning speed r_1
- t_2 = Time to reach turning speed $r_2 = 0$
- t_3 = Time to reach turning speed r_3
- t_4 = Time to reach turning speed $r_4 = 0$ (end of evasive action manoeuvre).
- δ = Rudder angle [°]
- r = Turning speed [°/min]

Annex 2 to instruction ESI-II-4
Report on evasive action manoeuvre and turning capacity

Inspection body:

Date:

Name:

Name of craft:

Owner:

Type of craft Test area:

or convoy: Relevant water level [m] :

$L \times B$ [m x m] : Depth of water h [m] :

T during test [m] : h/T :

Speed of the current [m/s]

Load % of maximum
(during test) [t] : deadweight:

Rate-of turn indicator
Type :

Type of rudder construction: normal construction/special construction *)

Active steering system: yes/no *)

Results of evasive action manoeuvres:

Time t_1 to t_4 required for the evasive action	Rudder angle δ or δ_a *) at which evasive action commences $r_1 = r_3$				Comments
	$\delta = 20^\circ$ TB*) $\delta_a = \dots$ TB*)	$\delta = 20^\circ$ BB*) $\delta_a = \dots$ BB*)	$\delta = 45^\circ$ TB*) $\delta_a = \dots$ TB*)	$\delta = 45^\circ$ BB*) $\delta_a = \dots$ BB*)	
	$r_1 = r_3 = \dots\dots\dots$ °/min		$r_1 = r_3 = \dots\dots\dots$ °/min		
t_1 [s]					
t_2 [s]					
t_3 [s]					
t_4 [s]					
Limit value t_4 according to 2.2	Limit value $t_4 = \dots\dots\dots$ [s]				

Turning capacity *)

Geographic position at start of turning manoeuvre: p.k.

Geographic position at end of turning manoeuvre: p.k.

Steering apparatus

Type of operation: manual/powered*):

Rudder angle for each turn of the wheel*): °

Angular velocity of the rudder over the whole range*): °/s

Angular velocity of the rudder over the range 35° Port to 35° Starboard *): °/s

*) Delete as appropriate

ESI-II-5 NOISE MEASUREMENTS

(Articles 3.04(7), 7.01(2), 7.03(6), 7.09(3), 8.10, 14.09(3), 15.02(5), 22.02(3)(b), 22.03(1))

1. General

In order to check the maximum sound pressure levels given in the Standard, measured values, measurement procedures and conditions for the quantitative, reproducible recording of sound pressure levels in accordance with (2) and (3)/(3a) shall be established.

2. Measuring instruments

The measuring instrument shall meet the requirements of class 1 according to European Standard EN 61672-1 : 2013.

Before and after each set of measurements, a class 1 calibrator according to European Standard EN 60942 : 2018 shall be placed on the microphone in order to calibrate the measurement system. The compliance of the calibrator with the requirements of European Standard EN 60942 : 2018 shall be checked once per year. The compliance of the measuring equipment with the requirements of EN 61672-1 : 2013 shall be checked every two years.

3. Noise measurements for craft which were laid down after 1 April 1976

3.1 On board craft

Measurements shall be carried out in accordance with International Standard ISO 2923 : 1996 Sections 5 to 8 measuring only A-weighted sound pressure levels.

3.2 Air noise emitted from craft

Noise emissions from craft on inland waterways and in ports are determined by means of measurements in accordance with European Standard EN ISO 2922 : 2020, Sections 7 to 11. Doors and windows of engine rooms shall be closed during measurements.

3a. Noise measurements for craft which were laid down on or before 1 April 1976

3a.1 On board craft

Measurements shall be carried out in accordance with the International Standard ISO 2923 : 1996, sections 5 to 8, measuring only A-weighted sound pressure levels.

By way of derogation from paragraph 7, the sound pressure levels in the wheelhouse, in the engine room, as well as in the living and sleeping quarters shall be determined as a weighted energy-average of the measurements under four measuring conditions as shown in the table below:

Measuring conditions	% MCR	% maximum speed	Weighting factor
A	5 %	37 %	$W_A = 0,26$
B	25 %	63 %	$W_B = 0,37$
C	55 %	82 %	$W_C = 0,23$
D	85 %	95 %	$W_D = 0,14$

The final result of the measurements per room is calculated using the following formula:

$$L_{waSN} = 10 \cdot \log(W_A \cdot 10^{(0,1 \cdot L_A)} + W_B \cdot 10^{(0,1 \cdot L_B)} + W_C \cdot 10^{(0,1 \cdot L_C)} + W_D \cdot 10^{(0,1 \cdot L_D)})$$

where:

L_{waSN} = weighted average sound pressure level for a vessel in dB(A);

L_A = measured vessel sound pressure level in dB(A) at measuring condition A;

L_B = measured vessel sound pressure level in dB(A) at measuring condition B;

L_C = measured vessel sound pressure level in dB(A) at measuring condition C;

L_D = measured vessel sound pressure level in dB(A) at measuring condition D,
and

W_A, W_B, W_C, W_D = weighting factors for measuring conditions A, B, C and D.

3a.2 Noise emitted by craft

The measurement of noise produced by craft on inland waterways and in ports shall be carried out in accordance with European Standard EN ISO 2922 : 2020, sections 7 to 11. Doors and windows of engine rooms shall be closed during measurements.

4. Reporting

Measurements shall be subject of a report in accordance with the "Noise Measurement Report"

- appendix 1 for craft which were laid down after 1 April 1976,
- appendix 2 for craft which were laid down on or before 1 April 1976.

Appendix 1
Noise Measurement Report
- Craft which were laid down after 1 April 1976 -
- on board craft in accordance with International Standard ISO 2923 : 1996
- air noise emitted from craft in accordance with European Standard
EN ISO 2922 : 2020*)

A Craft data

1. Craft type and name:

Unique European vessel identification number:

2. Owner:

.....

3. Main propulsion system

3.1 Main engines

Number	Manufacturer	Type	Year of construction	Power (kW)	Engine speed (min ⁻¹)	Two-stroke/four-stroke	Turbo-charged yes/no
1							
2							

3.2 Transmission

Manufacturer: Type: Gear reduction: 1.....

3.3 Propellers

Number: Number of blades: Diameter: mm Nozzle: yes/no^{*)}

3.4 Steering system

Type:

4. Generator sets:

Number	Propulsion of	Manufacturer	Type	Year of construction	Power (kW)	Engine speed (min ⁻¹)
1						
2						
3						
4						
5						

5. Noise reduction measures implemented:

.....
.....

6. Observations:

.....
.....

*) Delete as appropriate

B Measuring instruments used

1. Sound pressure level meter
 Manufacturer: Type: Latest check:
2. Octave/Third octave band analyser
 Manufacturer: Type: Latest check:
3. Calibrator
 Manufacturer: Type: Latest check:
4. Accessories

5. Observations:

C Measurement conditions — craft

1. Formation during the measurements:
2. Load/displacement^{*)}: t/m³ (approximately ... % of maximum value)
3. Speed of main engine: min⁻¹ (approximately ... % of maximum value)
4. Generator sets in service No
5. Observations:

D Measurement conditions — surroundings

1. Area of measurement: Upstream/downstream^{*)}
2. Water depth: m (Relevant water level = m)
3. Weather: Temperature: °C Wind strength: BF
4. External noise interference: yes/no^{*)}, if yes, specify:
5. Observations:

E Recording of measurement

1. Measurement carried out by:
2. Date:
3. Observations :
4. Signature :

* Delete as appropriate

F.1 Measurement results

Noise measurements on board craft

No.	Measurement point	Doors		Windows		Measured value in dB(A)	Observations
		open	closed	open	closed		

F.2 Measurement results

Measurement of air noise emitted from craft

No.	Measurement point	Measured values in dB(A)	Observations

Appendix 2
Protocol for measuring noise
- Crafts which were laid down on or before 1 April 1976 -

1. Measurement results

1.1 Measurements on board:

Date:	
Surveyor:	
Sound level meter type:	
Craft name:	
Unique European vessel identification number :	
Craft year built:	
Craft tonnage:	
Engine brand:	
Hp engine:	
Rigid mounting:	
Max engine speed:	
Propeller type:	

Brief explanation:

- fill in only the yellow fields,
- start with 85 and 55 % and check the outcome,
- for 25 % and 5 % the lowest value of 85 or 55 % is applied,
- in case of non-compliance: fill in 25 % and, if necessary, 5 %,
- when referring to compartments use "living quarter" or "sleeping cabin no." or "engine room" or "wheelhouse",
- for a manual calculation of the L_{waSN} MCR -mix the following calculation tool can be used:
- $$L_{waSN}[dB(A)] = 10 \log [0,26 \cdot 10^{(L_{5\%/10})} + 0,37 \cdot 10^{(L_{25\%/10})} + 0,23 \cdot 10^{(L_{55\%/10})} + 0,14 \cdot 10^{(L_{85\%/10})}]$$

	Living quarter	Sleeping cabin 1	Sleeping cabin 2	Sleeping cabin 3	Wheelhouse	Engine room		MCR coefficient
85 % MCR							$L_{Aeq} [dB(A)]$	0,14
55 % MCR							$L_{Aeq} [dB(A)]$	0,23
MCR -mix							$L_{Aeq} [dB(A)]$	0,37
25 % MCR							$L_{Aeq} [dB(A)]$	0,37
MCR -mix							$L_{Aeq} [dB(A)]$	
5 % MCR							$L_{Aeq} [dB(A)]$	0,26
L_{waSN} MCR-mix							$L_{Aeq} [dB(A)]$	
Reference values	70,5	60,5	60,5	60,5	70,5	110,5	$L_{Aeq} [dB(A)]$	

Calculation tool measuring 85 and 55 %		
85 %	55 %	L_{waSN}
x dB	x-10	x-6,5
x dB	x-9	x-6,1
x dB	x-8	x-5,6
x dB	x-7	x-5,1
x dB	x-6	x-4,5
x dB	x-5	x-3,9
x dB	x-4	x-3,2
x dB	x-3	x-2,4
x dB	x-2	x-1,7
x dB	x-1	x-0,8
x dB	x	x
x dB	x+1	x+0,3
x dB	x+2	x+0,5
x dB	x+3	x+0,9
x dB	x+4	x+1,3
x dB	x+5	x+1,8

1.2 Measurement of noise generated by craft (EN 2922 : 2020):

No	Measurement point	Value in dB(A) to be measured	Observations

2. Noise reduction measures implemented:

.....

3. Observations:

.....

4. Measurement conditions - craft

- a) Formation during the measurements:
- b) Load/displacement^{*)}: t/m³ (corresponding to approximately % of maximum value)
- c) Generator sets in service No.
- d) Observations:

5. Measurement conditions — surroundings

- a) Area of measurement: upstream / downstream*
- b) Water depth: m (relevant water level = m)
- c) Weather: Temperature: °C. Wind strength: BF
- d) External noise interference: no/yes*, if yes, specify
- e) Observations:

*) Delete as appropriate

ESI-II-6

APPROPRIATE AUXILIARY MEANS FOR OBSERVING THE AREA OF OBSTRUCTED VISION

(Article 7.02)

1. Introduction

For a number of reasons, whether as a result of the vessel's construction or the cargo, unobstructed all-round vision from the wheelhouse is unavoidably restricted to a greater or lesser degree. The restrictions affect sectors in the horizontal plane (angle of azimuth between 0 and 360° relative to the forward axis of the vessel and in the vertical plane (angle of elevation between -90 and + 90°, relative to the horizontal plane at the eye level of the helmsman).

Depending on whether people are embarking or disembarking, whether the vessel is docking or casting off, whether it is manoeuvring or underway, the helmsman needs to be able to see different sectors of his field of vision. For example, before casting off it is important to be able to check whether there is anyone remaining on the side deck or whether the area immediately abaft the stern is clear. While underway a higher priority is accorded to being able to see the area in front of the vessel owing to the rapidly changing position of one's own vessel in forward motion.

Technical auxiliary means afford an indirect view of sectors that cannot be seen directly. Although many of their capabilities surpass those of the human eye, they are not a complete substitute for a direct view. Nevertheless, they are sometimes also used as a supplement in sectors that can be seen directly.

Concerning the required information on areas of obstructed vision, it is necessary to differentiate whether the information of interest is purely the presence of an object, its visual characteristics (silhouette, colour) or its identity, or whether it is important from a navigational perspective to determine an object's range, course and speed. This question influences the selection of the type of technical auxiliary means.

Given the lower purchase and installation cost, superior performance, versatility and customisation potential of video systems compared with periscopes, periscopes are eliminated as technical auxiliary means.

2. Overview of appropriate auxiliary means

The following auxiliary means are fundamentally suited to observing areas of obstructed vision:

- mirrors,
- video systems and
- radar systems.

Auxiliary means that satisfy Part 4 of this instruction are suitable for observing areas of obstructed vision provided they comply with the specific conditions of use. The inspection body will only permit other auxiliary means if it is of the view that they provide a comparable degree of safety.

3. Characteristics of technical auxiliary means

3.1 Characteristics of mirrors

In principle, mirrors are sensor and display system in one. They reflect the incident light according to the law: "angle of incidence = angle of reflection" and afford indirect observation of the desired sector by deflecting the helmsman's field of view. They are used mainly for viewing side deck areas.

With plane mirrors the angle at the centre of the field of view remains unchanged, convex mirrors increase it. Mirrors do not work in the dark and may dazzle in direct sunlight.

Generally speaking the mirrors used for inland navigation are mass produced products designed for buses and HGVs, the characteristics of which are suitable for navigation purposes. Under ideal conditions (high quality, no fouling) the resolution of an image provided by a mirror is limited by the resolution of the eye of the observer.

3.2 Characteristics of video systems

With a high repetition rate, video systems provide a current image of the environment such as an observer would see were he to be where the camera is located. They comprise a video camera as the image sensor and a raster screen for displaying the recorded image (video monitor).

A simple electrical connection suffices for transmitting the signal between the camera and monitor. The power supply can also be provided via the signal cable.

Cameras can operate with either a fixed or variable focal length (zoom) and be installed either in a fixed position or on a swivelling and tilting head.

The images obtained by the (single lens) cameras are captured and displayed centrally on screens in the same way as perceived by the human eye. A major weakness of the central perspective is that it does not enable the range of the images displayed to be determined. This effect is very apparent with images captured using telephoto lenses (long focal length).

That is why the viewing direction and field of observation have to be well matched with the required use.

Video systems depend on the presence of low ambient brightness. Strong reflections on the water surface and direct sunlight can render the image unusable.

The technical characteristics of the monitor (image size, resolution, brightness) depend on the required use.

The resolution of the image is determined by the number of pixels of the image sensor in the camera and the number of pixels (and bandwidth of the video signal) of the monitor. Even a good commercial video system does not quite match the maximum resolution of the human eye.

3.3 Characteristics of radar systems

Radar systems feature a sensor (revolving antenna with transmitter and receiver) and a display device. The sensor uses a horizontally rotating antenna to “illuminate” narrow radial sectors with microwave pulses, captures the echoes returned by reflecting objects then displays them on a screen indicating range and bearing. This creates a scaled image of the environment relative to the vessel’s heading. This image enables objects at a range of 15 m and more to be determined with a resolution of approximately 5 m and their bearing to within around 0.5 °.

As radar impulses operate with their own transmission impulses, unlike the other technical auxiliary means mentioned above, they do not depend on the existence of ambient brightness.

However, they can only detect and determine the position of reflecting objects and generate an image of the environment resembling a map, faithfully depicting bearing and range. Radar systems are also unable to identify and depict object details which would make identification possible.

4. Appropriate auxiliary means for observing the area of obstructed vision

4.1 Mirrors

1. Shape
The shape of the mirror depends on the shape of the area to be observed. Rectangular mirrors lend themselves to observing side decks.
2. Size
The mirror’s surface area depends on the width of the sector one wishes to observe and the distance between the helmsman and the mirror.
3. Quality
Tried and tested mass produced products such as those for road vehicles (HGVs, buses) are to be used.
4. Curvature
Plane mirrors are to be used, not curved ones. When deemed useful, slightly curved mirrors may also be used.
5. Mounting bracket
The mounting bracket must ensure the mirror remains in a permanent and rigid position (free of vibration).
6. Protection against rain
The mirror is to be fitted such that it is protected against rain.
7. Frost protection
The build-up of hoar frost on the mirror is to be prevented.
8. Installation position
It must be possible for the helmsman to use the mirror without leaving his post; it must be sufficient for him to glance at or turn his head towards the mirror. That is why the upper edges of the outer bulkheads (and outer doors as well) of the wheelhouse are well suited as attachment points. The helmsman must have an unobstructed view of the mirror.
9. Adjustment
The direction of the parts of the vessel depicted (edges, walkways) must correspond to reality as closely as possible.

4.2 Video systems

4.2.1 Cameras

1. Camera type
Raster scan colour video camera with automatic black and white switching, image format, e.g. 4:3 ("landscape"), appropriate to the monitor being used.
2. Resolution
Equally good resolution in both the horizontal and vertical axes, preferably a minimum of 576 pixels on the narrow edge of the image, square pixels.
3. Light sensitivity
0.6 Lux in colour mode, 0.1 Lux in black and white mode (in accordance with European Standard EN 61146-1 : 1996 with the corresponding lens without image integration).
4. Image repetition frequency
Image repetition frequency of 25 images/s or more.
5. Viewing angle
The camera viewing angle is determined by selecting the appropriate focal length. To avoid irritating the user further with an unnatural perspective, it is recommended that the viewing angle be aligned with that of the human eye (approx. 30° to 45°). The horizontal viewing angle should not therefore be less than 30°.
6. Zoom lenses and slewing mechanisms
When using slewing and zoom cameras to assist forward vision there should be a basic setting for optimal focal length and forward pointing orientation that can be achieved at the press of a button.
7. Camera position
The camera position depends on the zone to be observed.
8. Camera mounting
The mounting bracket must ensure the camera remains in a permanent and rigid position (free of vibration). The mounting bracket can also comprise a protective heated enclosure.

4.2.2 Monitors

1. Monitor type
Raster screen (preferably TFT flat screen), minimum 30 cm screen diagonal.
2. Monitor location
 - a) All monitors displaying images from cameras predominantly pointing forward must be within the helmsman's field of vision so that he can see them without excessive movement of the head. They must be sited laterally to coincide with the cameras (port, amidships, starboard).
 - b) Monitors corresponding to cameras pointed aft can also, for example, be located in a second bank, centrally and on the correct side, below or above the aforementioned monitors. The image display is then consistent with that of the mirrors. If these images are only required when docking or casting off it is useful to locate these monitors on the after wheelhouse bulkhead as the helmsman is in any event looking aft or turning around when performing these manoeuvres. The images then no longer correspond to the mirror image.
3. Use of several monitors
The use of a single monitor to display a number of camera images (either simultaneously by splitting the screen into two or more zones or sequentially switching to the next camera) is not appropriate when looking forward.
4. Resolution
A minimum of 800 x 600 pixels.

5. Brightness
Minimum brightness: $FG \leq 15 \text{ cd/m}^2$; $BG \leq 5 \text{ cd/m}^2$. Maximum brightness $VG \geq 5000 \text{ cd/m}^2$
(FG = foreground; BG = background).

4.3 Radar systems

1. Radar systems
In addition to the minimum requirements and test conditions for navigational radar installations in inland navigation (ES-TRIN, Annex 5, Section I) the radar system must comply with the following requirements.
2. Antenna length
Minimum 1.80 m.
3. Near-field resolution
 $\leq 15 \text{ m}$.
4. Radial resolution
Pulse duration $\leq 5 \text{ m}$; pulse separation $\leq 15 \text{ m}$.
5. Azimuth resolution
 $\leq 1.2^\circ$.
6. Antenna height
The antenna height depends on the vessel's height and cargo. The antenna must be located at least 3 m above deck height to prevent accidents caused by rotation of the antenna.
7. Monitor type
A TFT flat panel monitor in portrait format must be used.
8. Image dimensions
The length of the shortest side of the screen must be a minimum of 270 mm.
9. Resolution
The resolution of the monitor must be identical in both directions and the pixels must be square. The narrow side must feature at least 1024 pixels (typically 1024 x 1280 pixels).
10. Brightness
Minimum brightness: $FG \leq 15 \text{ cd/m}^2$; $BG \leq 5 \text{ cd/m}^2$.
11. Monitor location/operation
The radar screen and its controls must be installed in accordance with the requirements for installation and performance tests for navigational radar installations and rate-of-turn indicators in inland navigation (ES-TRIN, Annex 5, Section III, Article 4).

ESI-II-7
USED OIL COLLECTION FACILITIES

(Article 8.09)

Existing vessels referred to in Article 32.02(1), whose permanently installed bilge pumping and drainage systems and static oil separators have been removed from their engine rooms, no longer comply with Article 5.07 of the RVIR in force as at 31.12.1994.

In accordance with the transitional provisions, these vessels must be equipped with a used-oil collection tank referred to in Article 8.09(2), with the exception of those cases referred to in Article 8.09(3).

ESI-II-8
(LEFT VOID)

ESI-II-9
AUTHORISATION AND TEST PROCEDURE OF SPECIAL ANCHORS WITH
REDUCED MASS

(Article 13.01(1) to (4))

1. Chapter 1 — Authorisation procedure

- 1.1** Special anchors with reduced mass in accordance with Article 13.01(5) shall be authorised by the competent authorities. The competent authority determines the authorised reduction of anchor mass for special anchors in accordance with the procedure outlined below.
- 1.2** Authorisation as special anchor is only possible if the reduction of anchor mass established is at least 15 %.
- 1.3** Applications for the authorisation of a special anchor in accordance with (1.1) shall be submitted to the competent authority of a Member State. Ten copies of the following documents shall be forwarded with each application:
- a) an outline of the dimensions and mass of the special anchor, giving the main dimensions and type designation for each available anchor size;
 - b) a braking force diagram for the reference anchor *A* (in accordance with (2.2)) and the special anchor *B* to be authorised which has been prepared and assessed by an institution designated by the competent authority.
- 1.4** The competent authority notifies CESNI of any applications to reduce anchor mass which it considers to authorise after testing.
- 1.5** The list of special anchors with reduced mass is published on the CESNI website (<https://listes.cesni.eu>).

2. Chapter 2 — Test Procedure

- 2.1** The braking force diagrams in accordance with (1.3) shall show the braking forces as a function of speed for the reference anchor *A* and the special anchor *B* to be authorised on the basis of tests in accordance with (2.2) to (2.5) below. Annex 1 shows one possible braking force test.
- 2.2** The reference anchor *A* used in the tests shall be a conventional folding stockless anchor corresponding to the sketch and details given below, with a mass of at least 400 kg.

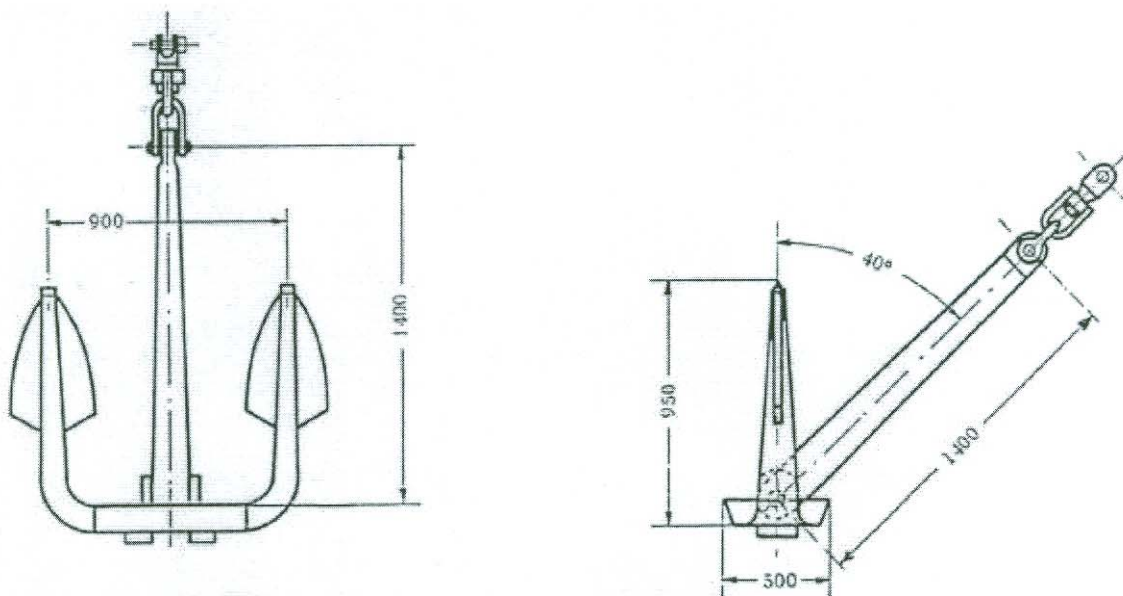

A tolerance of $\pm 5\%$ applies to the dimensions and mass given. However, the surface area of each fluke must be at least $0,15\text{ m}^2$.

- 2.3** The mass of the special anchor *B* used in the tests shall not deviate by more than 10% from the mass of the reference anchor *A*. If the tolerances are greater, the forces shall be recalculated proportional to mass.
- 2.4** Braking force diagrams shall give a linear representation of speed (v) in the range 0 to 5 km/h (speed over ground). To this end, three tests shall be carried out in an upstream direction for the reference anchor *A* and the special anchor *B* on an alternating basis over each of two stretches of river determined by the competent authority, one with coarse gravel and one with fine sand. On the River Rhine the stretch between $401\text{--}402\text{ km}$ can serve as a reference stretch for the coarse gravel tests and the stretch between $480\text{--}481\text{ km}$ for the fine sand tests.
- 2.5** For each test, the anchor being tested shall be towed with a steel wire cable whose length between the points of connection on the anchor and on the towing craft or device is 10 times the height of the connection point on the craft above the anchorage ground.

2.6 The percentage of reduction of anchor mass is calculated by the following formula:

$$r = 75 \cdot \left(1 - 0,5 \frac{PB}{PA} \left(\frac{FA}{FB} + \frac{AA}{AB} \right) \right) [\%]$$

where

- r = the percentage of reduction of anchor mass of special anchor B in relation to reference anchor A ;
- PA = the mass of reference anchor A ;
- PB = the mass of special anchor B ;
- FA = holding force of reference anchor A at $v = 0,5$ km/h;
- FB = holding force of special anchor B at $v = 0,5$ km/h;
- AA = the surface area on the braking force diagram defined by
- the line parallel to the y-axis at $v = 0$
 - the line parallel to the y-axis at $v = 5$ km/h
 - the line parallel to the x-axis at holding force $F = 0$
 - the braking force curve for reference anchor A ;
- AB = same definition as for AA except that the braking force curve for special anchor B is used.

**Model braking force diagram
(Determining the surface areas AA and AB)**

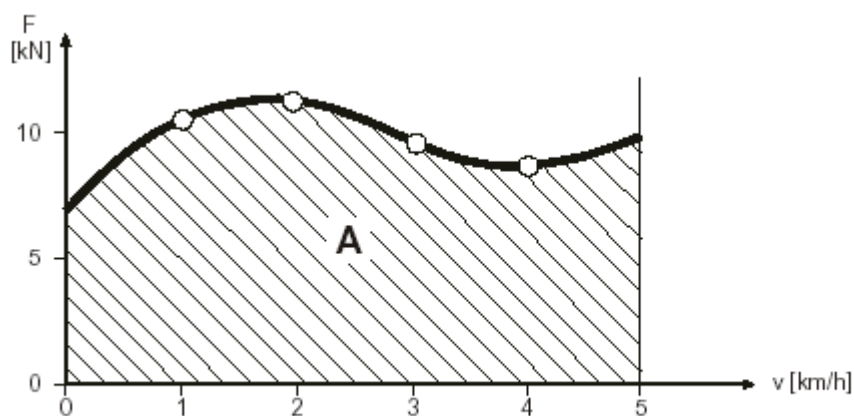

2.7 The acceptable percentage is the average of six values of r calculated in accordance with (2.6).

3. Chapter 3 - Anchors for recreational craft

3.1 For recreational craft, the inspection body may also authorise special anchors with reduced mass in accordance with the rules of a recognised classification society.

ESI-II-10
AUTOMATIC PRESSURISED WATER SPRINKLER SYSTEMS

(Article 13.04(1), (4) and (5))

Suitable automatic pressurised water sprinkler systems as in Article 13.04(1), (4) and (5) shall meet the following requirements:

1. The automatic pressurised water sprinkler system shall be ready for service at all times when there are persons on board. No additional action by crew members shall be required to trigger operation.
2. The system shall be permanently maintained at the necessary pressure. The pipes shall be filled with water up to the spray nozzles at all times. The system shall have a continuously working water supply. It shall not be possible for impurities harmful to operation to enter the system. Appropriate display instruments and test systems (e.g. pressure gauges, pressure-tank water level indicators, pump test piping) shall be installed for monitoring and checking the system. The pressurised water sprinkler systems located in the cold storage and freezer rooms should not be permanently filled with water. These rooms can be protected with dry sprinklers or filled with appropriate antifreeze.
3. The pump for the water supply to the spray nozzles shall be activated automatically by a pressure drop in the system. The pump shall be dimensioned so that it can continuously provide a sufficient water supply at the necessary pressure if all the spray nozzles necessary for covering the area of the largest room to be protected are activated simultaneously. The pump shall supply the automatic pressurised water sprinkler system exclusively. In the event of pump failure, it shall be possible to provide the spray nozzles with a sufficient water supply from another on-board pump.
4. The system shall be divided into sections, each with no more than 50 spray nozzles. A larger number of spray nozzles may be authorised by the inspection body with appropriate corroboration, in particular a hydraulic calculation.
5. The number and the layout of spray nozzles shall ensure effective distribution of water in the rooms to be protected.
6. Spray nozzles shall be triggered at a temperature between 57 °C and 79 °C, in the galley areas at a maximum of 93 °C and in the saunas at a maximum of 141 °C.
7. The installation of components of automatic pressurised water sprinkler system within the rooms to be protected shall be limited to the necessary minimum. No such system components shall be installed in main engine rooms.
8. Optical and acoustic indicators shall be provided in one or more suitable locations, at least one of which must be permanently manned, displaying activation of automatic pressurised water sprinkler system for each section.
9. The energy supply of the installation of automatic pressurised water sprinkler system shall be provided by two independent energy sources that shall not be installed in the same location. Each energy source shall be capable of supplying the entire system unassisted.

10. An installation plan of the automatic pressurised water sprinkler system shall be presented to the inspection body for examination before installation of the system. The plan shall indicate the types and performance data of the machines and equipment used. A system tested and certified by a recognised classification society which complies at least with the above prescriptions can be authorised without further testing.
11. The presence of an automatic pressurised water sprinkler system shall be entered in the inland navigation vessel certificate under item 43.

ESI-II-11
STEERAGEWAY UNDER VESSEL'S OWN POWER

(Article 7.04(11), Article 9.09(2)(a), (4)(a), (5)(a), Article 11.01(3), Article 11.04(3), Article 11.08(1) and (2), Article 13.05(2)(a) Article 19.07(1) Article 28.04(1)(a), Article 30.07)

1. Minimum requirements for vessel's steerageway

Steerageway under a vessel's own power in accordance with Articles

- 7.04(11),
- 9.09(2)(a), (4)(a), (5)(a),
- 11.01(3),
- 11.04(3),
- 11.08(1) and (2),
- 13.05(2)(a),
- 19.07(1),
- 28.04(1)(a) and
- 30.06

is deemed to be sufficient if the vessel or the formation propelled by the vessel attains a speed of 6,5 km/h in relation to the water and a rate of-turn of 20°/min can be induced and maintained while under way at a speed of 6,5 km/h in relation to the water.

2. Navigation tests

On verifying the minimum requirements Articles 5.03 and 5.04 shall be complied with.

ESI-II-12
APPROPRIATE FIRE ALARM SYSTEM

(Article 13.05(3), Article 13.06(2)(b), Article 19.11(18), Article 29.10(1))

Fire alarm systems are considered to be appropriate if they meet the following provisions.

0. Components

0.1 Fire alarm systems consist of :

- a) fire detectors, manual call points and other sensors,
- b) fire alarm central,
- c) fire alarm and indicator devices, including transmission devices where appropriate as well as the external power supply.

0.2 The fire alarm system may be divided into one or more fire detection zones.

0.3 The fire alarm system may have one or more control and display panels.

0.4 The fire alarm central is the central control unit of the fire alarm system. It is used to receive the input signal from a detector, process the signal and generate an output signal to the fire alarm and indicator devices. The fire alarm central has one or more control and display panels.

0.5 A fire detection zone may have one or more manual call points or fire detectors.

0.6 Fire detectors, manual call points and other sensors are used to automatically detect or report a fire and send an appropriate signal to the fire alarm central.

Fire detectors automatically monitor their fire detection zone based on their type of corresponding parameters. They can be designed as

- a) heat detectors,
- b) smoke detectors,
- c) ion detectors,
- d) flame detectors,
- e) pressure detectors,
- f) combustion gas detector,
- g) combination detectors (fire detectors combining two or more of the detectors listed in (a) to (f)).

Fire detectors which respond to other factors indicating the onset of a fire may be approved by the inspection body provided that they are no less sensitive than the fire detectors referred to under (a) to (g).

Manual call points are used for manual activation and can be designed with direct or indirect triggering (with or without actuation protection).

In addition, actuating devices of other monitoring systems (detectors not belonging to the fire alarm system) can be connected.

Fire detectors can be designed with or without individual identification.

- 0.7 Alarm devices are optical (e.g. flashing light) and acoustic (e.g. siren) signaling devices, which are activated upon the signal from the fire alarm central and announce the fire alarm.
- 0.8 Control and display panels and indicator devices are used to monitor, operate and provide information to operators (e.g. crew, on-board personnel, fire department).

Indicator devices make the information provided by the fire alarm system visible (e.g. by signal lamps, screen displays).

1. Construction requirements

1.1 General

- 1.1.1 Compulsory fire alarm systems shall be operational at all times.
- 1.1.2 Rooms and areas monitored by the fire alarm system must be equipped with fire detectors required in accordance with (2.2). Additional manual call points may be installed.
- 1.1.3 The system and its components shall be able to withstand voltage fluctuations and surges, changes in ambient temperature, vibrations, humidity, shocks, impacts and corrosion such as commonly occur on vessels.

1.2 Energy supply

- 1.2.1 Energy sources and electric circuits necessary for the operation of the fire alarm system shall be self monitoring. Any fault occurring shall activate an optical and acoustic failure signal on the fire alarm central which can be distinguished from a fire alarm signal.
- 1.2.2 The fire alarm system shall be supplied at least by two power sources, one of which shall be an emergency power system (i.e. emergency power source and emergency switchboard). There shall be two separate power-feeds solely for this purpose. These shall lead to an automatic switch in or near the fire alarm central. On motor vessels a separate emergency power supply is sufficient.

1.3 Fire detection system

- 1.3.1 Manual call points and fire detectors shall be grouped in fire detection zones.

- 1.3.2 Fire alarm systems shall not be used for any other purpose. By way of derogation the closing of the doors in accordance with Article 19.11(9) and similar functions may be triggered at the control panels of the fire alarm system and indicated on the control panels and indicator devices.
- 1.3.3 Fire alarm systems shall be designed in such a way that the first indicated fire alarm does not prevent fire alarms set off by other manual call points or automatic fire detectors.

1.4 Fire detection zones

- 1.4.1 Where the fire alarm system cannot remotely identify individually the manual call points or fire detectors, a fire detection zone shall not comprise more than one deck. This does not apply to a fire detection zone which comprises an encapsulated stairwell.

In order to avoid delays in detecting the origin of the fire, the number of enclosed spaces included in each fire detection zone shall be limited. There shall not be more than fifty enclosed rooms in one fire detection zone.

Where the fire alarm system can remotely identify individually the manual call points or fire detectors, the fire detection zones may comprise several decks and any number of enclosed rooms.

- 1.4.2 On passenger vessels which do not have a fire alarm system with remote identification of individual manual call points or fire detectors, a fire detection zone shall not comprise more than the area constituted in accordance with Article 19.11(11). The activation of a fire detector in an individual cabin in this fire detection zone shall set off an optical and acoustic signal in the passageway outside that cabin.
- 1.4.3 Galleys, engine rooms and boiler rooms shall constitute separate fire detection zones.

1.5 Fire detectors

- 1.5.1 Only heat, smoke or ion detectors shall be used as fire detectors. Other types may only be used as additional detectors.
- 1.5.2 Fire detectors shall be type-approved.
- 1.5.3 All fire detectors shall be designed in such a way that they can be tested to ensure that they are working properly and brought back into service without having to replace any components.
- 1.5.4 Smoke detectors shall be set so that they respond to a reduction in visibility per metre caused by smoke of more than 2 % to 12,5 %. Smoke detectors fitted in galleys, engine rooms and boiler rooms shall respond within sensitivity limits meeting the requirements of the inspection body, whereby under-sensitivity or over-sensitivity of the smoke detectors shall be avoided.

- 1.5.5 Heat detectors shall be set so that with temperature increase rates of less than 1 °C/min they respond at temperatures of between 54 °C and 78 °C.

With higher rates of temperature increase, the heat detector shall respond within temperature limits where under- or over-sensitivity of the heat detector is avoided.

- 1.5.6 With the agreement of the inspection body, the permissible operating temperature of heat detectors may be increased to 30 °C above the maximum temperature in the upper part of engine and boiler rooms.
- 1.5.7 The sensitivity of flame detectors shall be sufficient to detect flames against an illuminated background. Flame detectors shall also be equipped with a system for identifying false alarms.

1.6 Fire alarm central

- 1.6.1 Activation of a manual call point or fire detector shall set off an optical and acoustic fire alarm signal at the control and display panel and the indicator devices of the fire alarm central.
- 1.6.2 The control, panels and the indicator devices of the fire alarm central shall be at a location which is permanently manned by shipboard personnel. One control and display panel and indicator device shall be at the steering position.
- 1.6.3 The display panels and indicator devices shall indicate at least the fire detection zone in which a manual call point or fire detector has been activated.
- 1.6.4 On or near each display panel and indicator device there shall be clear information on the rooms monitored and the location of the fire detection zones.

2. Installation requirements

- 2.1 Manual call points or fire detectors shall be installed in such a manner as to ensure the best possible operation of the system. Locations in the vicinity of deck girders and ventilation shafts or other locations where air currents could adversely affect system operation and locations where impacts or mechanical damage are likely shall be avoided.
- 2.2 In general, fire detectors located on the ceiling shall be at least 0,5 metres away from bulkheads. The maximum distance between fire detectors and bulkheads shall conform to the following table:

Type of fire detector	Maximum floor surface area per fire detector	Maximum distance between fire detectors	Maximum distance of fire detectors from bulkheads
Heat	37 m ²	9 m	4,5 m
Smoke	74 m ²	11 m	5,5 m

The inspection body may stipulate or approve other distances on the basis of tests which prove the characteristics of the automatic fire detectors.

Other types of fire detectors must be installed according to the criteria specified by the manufacturer.

- 2.3 The routing of electric cables for the fire alarm system through engine rooms and boiler rooms or other high fire risk rooms is not permitted unless this is necessary for fire detection through manual call points or fire detectors or fire alarm device in those rooms or connection to the corresponding power supply.

3. Acceptance test

- 3.1 Fire alarm systems must be checked by an expert:

- a) before being put into service for the first time,
- b) before being put back into service after any major modification or repair,
- c) regularly, at least every two years.

In the case of engine rooms and boiler rooms these checks shall be made under various machine operation conditions and under changing ventilation conditions. Tests as referred to in subsection (c) above may also be carried out by a competent person from a competent firm specialising in fire extinguishing systems.

- 3.2 An inspection certificate shall be issued, signed by the expert or competent person and showing the date of the inspection.

ESI-II-13 MODEL FOR A LIMITED GENERAL PLAN OF THE ELECTRICAL INSTALLATION FOR CRAFT WHICH WERE LAID DOWN ON OR BEFORE 1 APRIL 1976

(Article 32.04(3))

Example 1

Switchboard 380 V

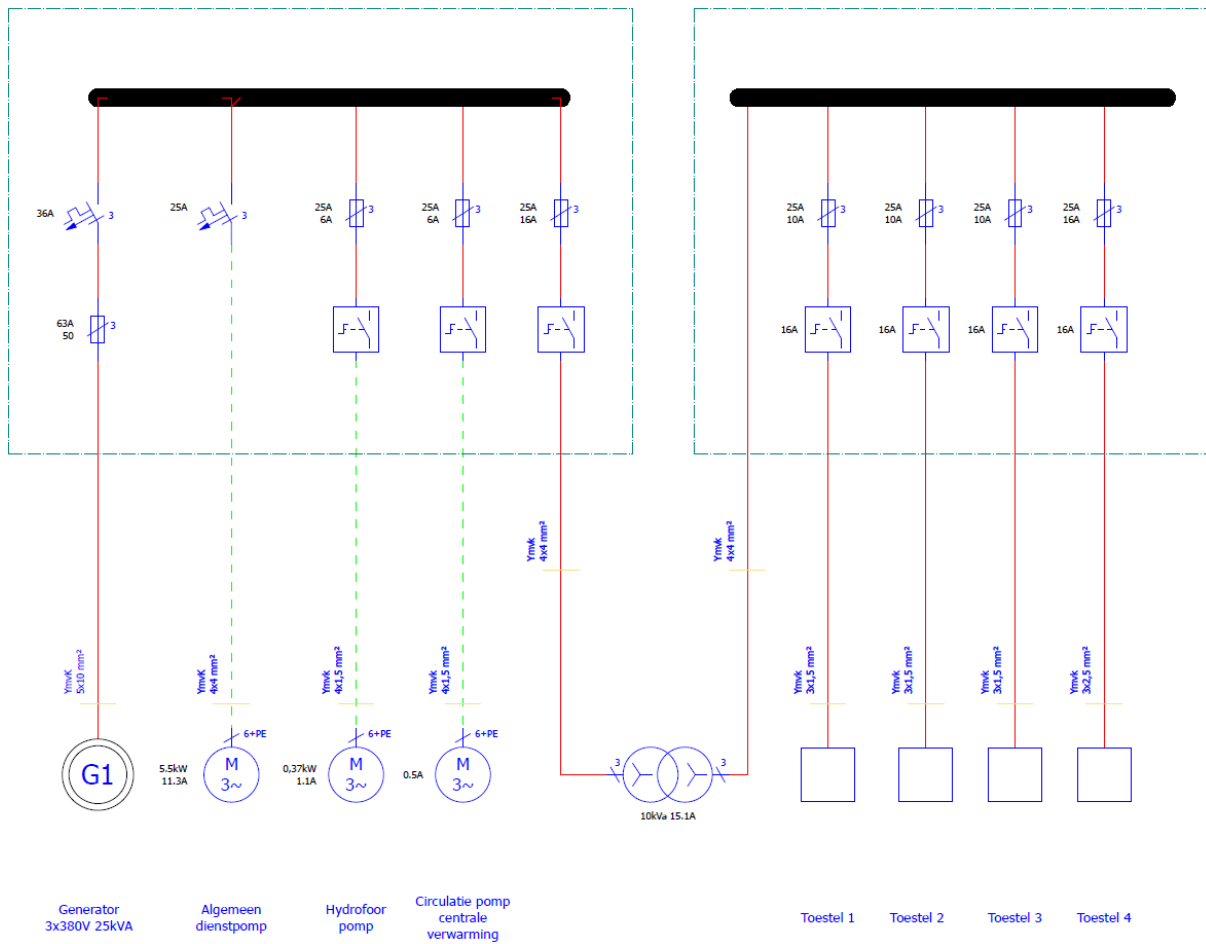

Example 2

Switchboard wheelhouse 24 V

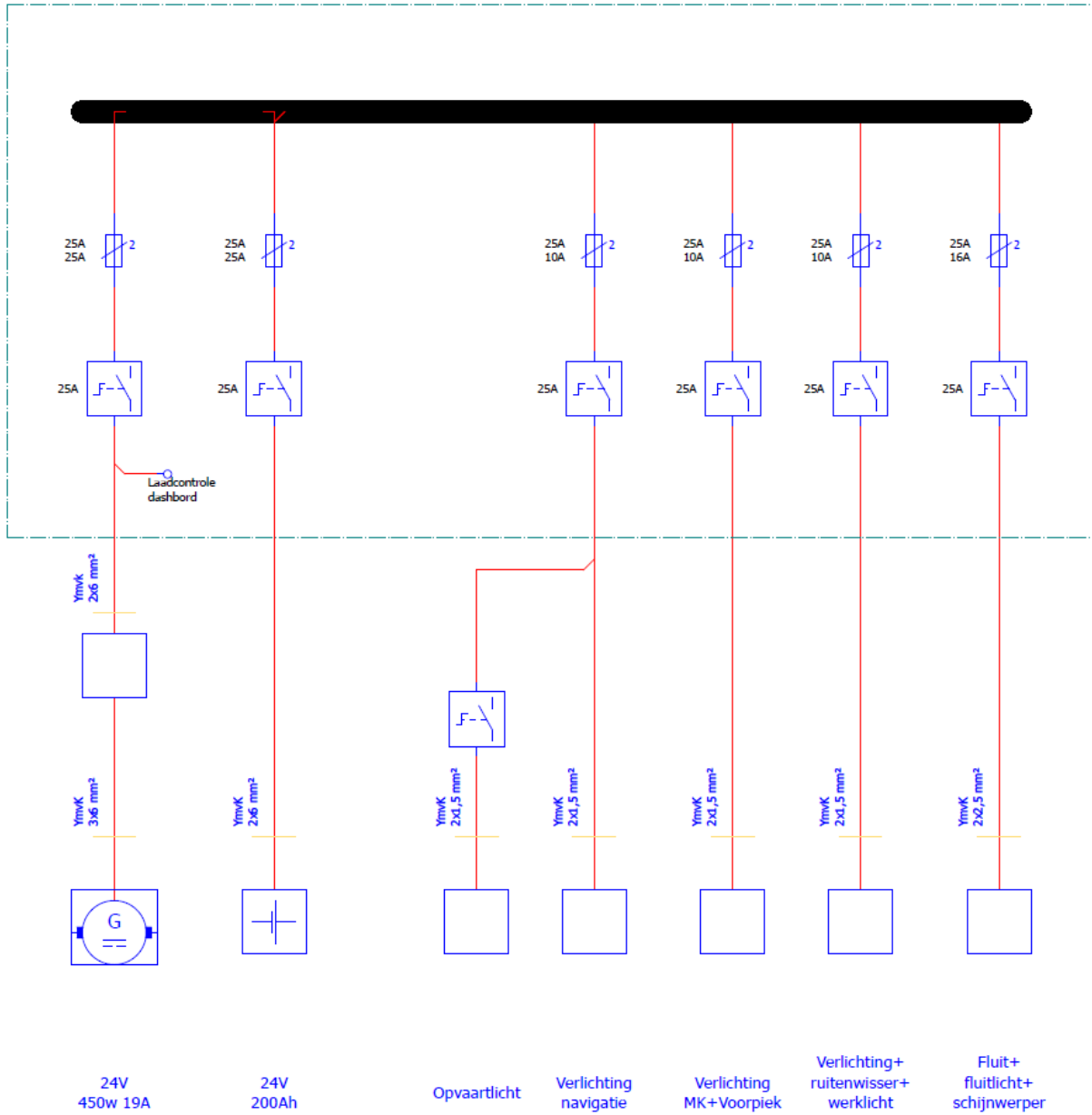

ESI-II-14

COLOUR CODING FOR FILLER NECKS

(Articles 8.05(5), 8.06(6), 8.07(5), 15.05(1))

The filler necks of

- fuel tanks,
- lubricating oil tanks,
- tanks for oils used in power transmission systems, control and activating systems or heating systems and
- potable water installations

must be distinctly marked. It is advisable to distinctly mark other filler necks.

The markings are considered sufficiently clear if, in addition to the prescribed standardised connection piece (for fuels), they are also provided with the following advised unique colour coding.

Diesel oil

Brown or Brown/Yellow/Brown if other fuels are available on board (in accordance with international standard ISO 14726 : 2008)

Lubricating oil

Orange or Orange Yellow Orange if other oils (which are not fuels) are available on board (in accordance with international standard ISO 14726 : 2008)

Hydraulic fluids (power transmission purposes)

Orange/Grey/Orange (in accordance with international standard ISO 14726 : 2008)

Water (drinking water)

Blue (in accordance with international standard ISO 14726 : 2008)

Water (fire-fighting)

Red (in accordance with international standard ISO 14726 : 2008)

In order to be visible to those in charge of bunkering, the colour coding can be implemented in different ways:

- a) on the pipe with a coloured self-adhesive tape;
- b) with painted colour stripes; or
- c) by colouring (painting) the pipes throughout their length.

Where the colour coding is implemented in accordance with (a) with self-adhesive tape or (b) with painted colour stripes, such coding shall be implemented at least near the connecting points, and bulkhead and deck penetrations.

PART III SPECIAL PROVISIONS

ESI-III-1

APPLICATION OF CHAPTER 19 REQUIREMENTS

- **Local subdivisions**
- **Transitional provisions for enclosures made with awnings or similar mobile installations**

(Article 19.02(5), 19.03(5))

1. Local subdivisions (Article 19.02(5))

Under Article 19.02(5) it is conceivable that local watertight subdivisions, such as transversally subdivided double bottom tanks of a greater length than the damage length to be considered, will not be included in the evaluation. In this case it might not be possible to take the transversal subdivision into account if it is not extended up to the bulkhead deck. This might lead to inappropriate subdivisions of bulkheads.

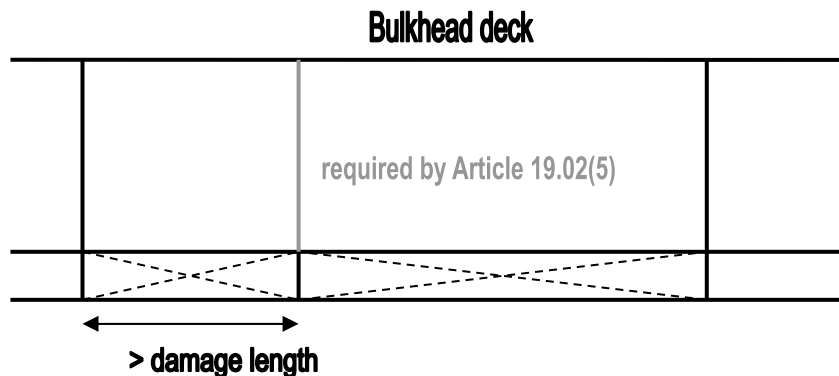

Interpretation of the requirement:

If a watertight compartment is longer than required by Article 19.03(9) and it contains local subdivisions which form watertight sub compartments, and between which the minimum damage length can be contained, these can be taken into account in the damage stability calculation.

2. Transitional provision for enclosures made with awnings or similar mobile installations with regard to stability (Article 19.03(5))

Enclosures made with awnings or similar mobile installations can cause problems with the stability of the vessel since, if of sufficient size to do so, they influence the heeling moment due to wind pressure.

Interpretation of the requirement:

In the case of passenger vessels for which a vessel certificate was issued for the first time before 1 January 2006 according to RVIR, or for which Article 32.05(2), second sentence, is invoked, after the erection of an enclosure made with awnings or similar mobile installations, a new stability calculation must be made according to Article 19.04 of this Standard, in so far as its lateral plane A_{wz} exceeds 5 % of the total lateral plane A_w to be taken into account in each case.

ESI-III-2

SPECIFIC SAFETY NEEDS OF PERSONS WITH REDUCED MOBILITY

(Article 1.01(12.2), Article 19.01(4) , Article 19.06(3) to (5), (9), (10), (13) and (17), Article 19.08(3), Article 19.10(3), Article 19.13(1) to (4))

1. Introduction

Persons with reduced mobility have safety needs exceeding those of other passengers. These needs are taken into account in the requirements of Chapter 19, which are explained as follows.

These requirements are intended to ensure that persons with reduced mobility can stay and move safely on board vessels. In addition, in an emergency such persons should have the same level of safety as other passengers.

It is not necessary that all passenger areas fulfil the specific safety requirements of persons with reduced mobility. Therefore those requirements apply only to certain areas. However, the persons in question must be given the opportunity of being informed of the areas specially adapted for them in view of safety, so that they can organise their stay on board accordingly. It is the responsibility of the ship-owner to make the corresponding areas available, make them known and communicate them to persons with reduced mobility.

The provisions concerning persons with reduced mobility make reference to:

- Directive 2009/45/EC¹ and
- the guide for the adaptation of inland waterway passenger vessels to people with disabilities in accordance with Resolution No 69 of the UNECE².

The definition of the term 'persons with reduced mobility' used in the Standard is largely identical to that of the Directive and most of the technical requirements are based on the above mentioned guide. In cases of doubt, therefore, both can be referred to when taking decisions. In general, the requirements of the Directive and the guide go beyond those of this Standard.

The requirements of the Standard do not concern berthing locations and similar installations. These are subject to national provisions.

2. Article 1.01(12.2) – term 'persons with reduced mobility'

'Persons with reduced mobility' means anyone who, as a result of physical impairments, cannot move or distinguish their surroundings in the same way as other passengers. This definition includes persons with impaired eyesight or hearing or persons accompanying children in buggies or being carried. However, for the purposes of these provisions, persons with reduced mobility do not include anyone with psychic impairments.

¹ Directive 2009/45/EC of the European Parliament and of the Council of 6 May 2009 establishing safety rules and standards for passenger ships (OJ L 163, 25.6.2009).

² Guidelines for passenger vessels also suited for carrying persons with reduced mobility - United Nations Economic Commission for Europe, Inland Transport Committee, Working Group on Inland Water Transport - Adopted on 15 October 2010.

3. **Article 19.01(4) — General provisions; Areas provided for use by persons with reduced mobility**

Areas provided for use by persons with reduced mobility range from, in the simplest case, the entrance area to the areas from which an evacuation will take place in an emergency. They shall include:

- a place where life-saving equipment is stowed or issued in an emergency,
- seats,
- a suitably-adapted toilet (see (10) of this instruction),
- connecting corridors, and
- a suitably-adapted cabin (for cabin vessels only).

The number of seats corresponds at least approximately to the number of persons with reduced mobility that — over a lengthy period — are most frequently onboard simultaneously. The number should be determined by the ship-owner on the basis of experience, as this is beyond the knowledge of the competent authority. The number of seats for persons with reduced mobility shall not be less than 1 % (rounded up to the nearest whole number) of the permitted number of passengers.

On cabin vessels consideration shall also be given to connecting corridors to passenger cabins used by persons with reduced mobility. The number of such cabins is to be determined by the ship-owner in the same way as the number of seats. The number of cabins for persons with reduced mobility cannot be less than

- a) one for cabin vessels with sleeping berths for a maximum of 200 passengers,
- b) two for cabin vessels with sleeping berths for more than 200 passengers.

With the exception of the width of doors, no requirements are imposed for the special arrangement of cabins. It is the responsibility of the owner to make any further necessary arrangements.

4. **Article 19.06(3)(g) — Exits of rooms**

With regard to the requirements concerning the width of connecting corridors, exits and openings in bulwarks or guard rails intended for use by persons with reduced mobility or usually used for the embarkation or disembarkation of persons with reduced mobility, consideration shall be given to buggies and the fact that people may be dependent on various types of walking aids or wheelchairs. In the case of exits or openings for embarkation or disembarkation account shall also be taken of the additional space needed for any assisting staff.

5. **Article 19.06(4)(d) — Doors**

The requirements regarding the arrangement of the area surrounding doors intended for use by persons with reduced mobility shall ensure that persons dependent for example on walking aids can open such doors safely.

6. Article 19.06(5)(c) — Connecting corridors

See (4) of this instruction.

7. Article 19.06(9) — Stairways and elevators

The requirements for the arrangement of stairways shall, in addition to possible reduced mobility, also take into account eyesight impediments.

8. Article 19.06(10)(a) and (b) — Bulwarks and guard rails

The requirements for bulwarks and guard rails of decks intended for use by persons with reduced mobility shall provide for a greater height since such persons are more likely to lose their balance or be unable to hold on by themselves.

See also (4) of this instruction.

9. Article 19.06(13) — Passageways

For various reasons, persons with reduced mobility need to support themselves or hold on more frequently, so walls in passageways intended for use by persons with reduced mobility shall be equipped with handrails at an appropriate height.

See also (4) of this instruction.

10. Article 19.06(17) — Toilets

Persons with reduced mobility shall also be able to stay and move safely in toilets, so at least one toilet shall be adapted accordingly.

11. Article 19.08(3)(a) and (b) — Alarm system

Persons with reduced mobility are more likely to encounter situations in which they are dependent on the help of others. In rooms in which, as a general rule, they cannot be seen by crew members, shipboard personnel or passengers, the possibility of triggering an alarm should therefore be provided for. This applies to toilets intended for use by persons with reduced mobility.

Persons with reduced mobility include persons with impaired eyesight or hearing. Consequently, at least in areas intended for use by persons with reduced mobility, the passenger alarm system shall provide suitable visual and audible alarms.

12. Article 19.10(3)(d) — Sufficient lighting

Persons with reduced mobility also include persons with impaired eyesight. Sufficient lighting in areas intended for use by persons with reduced mobility is therefore essential and shall meet higher requirements than lighting for other passenger areas.

13. Article 19.13(1) — Safety rota

The special safety measures necessary for persons with reduced mobility to be taken into consideration in the safety rota shall take into account both the possibility of reduced mobility and impaired hearing and eyesight. For such persons measures for normal operation shall be taken into account in addition to measures in the event of emergencies.

14. Article 19.13(2) — Safety plan

The areas covered by (3) of this instruction shall be designated.

15. Article 19.13(3)(b) — Displaying the safety rota and the safety plan

At least the copies of the safety rota and the safety plan displayed in the areas intended for use by persons with reduced mobility shall be such that they can, where possible, also be read by persons with impaired eyesight. This can be achieved for example by appropriate use of contrast and character size.

In addition, the plans shall be displayed at a height so that wheelchair users can read them as well.

16. Article 19.13(4) — Code of conduct for passengers

(15) of this instruction applies accordingly.

ESI-III-3
STRENGTH OF WATERTIGHT WINDOWS

(Article 19.02(16))

1. General

According to Article 19.02(16), watertight windows may be situated below the margin line if they are watertight, cannot be opened, possess sufficient strength and conform to Article 19.06(14).

2. Construction of watertight windows

The requirements of Article 19.02(16) are deemed to be fulfilled if the construction of watertight windows complies with the following provisions.

- 2.1 Only pre-stressed glass complying with International Standard ISO 614 : 2012, shall be used.
- 2.2 Round windows shall comply with International Standard ISO 1751 : 2012,
Type B: medium-type windows
Model: non-opening windows.
- 2.3 Angular windows shall comply with International Standard ISO 3903 : 2012,
Type E: heavy-duty windows
Model: non-opening windows.
- 2.4 ISO Standard windows may be replaced by windows whose construction is at least equivalent to the requirements of (2.1) to (2.3).

ESI-III-4 SAFETY GUIDANCE SYSTEM

(Article 19.06(7), Article 29.09(d))

1. General

- 1.1 According to the abovementioned provisions, passenger vessels and high-speed vessels shall have suitable guidance systems to clearly identify the escape routes and emergency exits when the normal emergency lighting is less effective due to smoke. Such guidance systems shall take the form of low-location lighting (LLL). This instruction covers the approval, installation and maintenance of such guidance systems.
- 1.2 In addition to the emergency lighting required by Article 19.10(3) the escape routes, including stairways, exits and emergency exits, shall be marked by low-location lighting (LLL) throughout the whole of the escape route, particularly at corners and intersections.
- 1.3 The LLL system shall function for at least 30 minutes after its activation.
- 1.4 LLL products shall be neither radioactive nor toxic.
- 1.5 Instructions on the LLL system shall be displayed with the safety plan in accordance with Article 19.13(2) and in every cabin.

2. Definitions

- 2.1 Low-location lighting (LLL) — Electrically powered lighting or photoluminescent indicators placed along the escape routes so as to ensure that all such routes can be easily identified.
- 2.2 Photoluminescent (PL) system — An LLL system which uses PL material. Photoluminescent material contains a chemical (example: zinc sulphide) that has the quality of storing energy when illuminated by visible light. The PL material emits light which becomes visible when the ambient light source is less effective. Without the light source to re-energise it, the PL material gives off the stored energy for a period of time with diminishing luminance.
- 2.3 Electrically powered (EP) system — An LLL system which requires electrical power for its operation, such as systems using incandescent bulbs, light-emitting diodes, electroluminescent strips or lamps, electrofluorescent lamps, etc.

3. Passageways and stairways

- 3.1 In all passageways, the LLL shall be continuous, except where interrupted by corridors and cabin doors, in order to provide a visible delineation along the escape route. LLL systems in compliance with an International Standard having a visible delineation without being continuous shall also be acceptable. The LLL shall be installed at least on one side of the corridor, either on the wall no more than 0,3 m from the floor, or on the floor no more than 0,15 m from the wall. In corridors more than two metres wide, LLL shall be installed on both sides.
- 3.2 In dead-end corridors, the LLL shall have arrows placed at intervals of no more than 1 m, or equivalent direction indicators, pointing in the direction of the escape route.
- 3.3 In all stairways, LLL shall be installed on at least one side at no more than 0,3 m above the steps, which will make the location of each step readily identifiable to any person standing above and below that step. Low-location lighting shall be installed on both sides if the width of the stairway is 2 m or more. The top and bottom of each set of stairs shall be identified to show that there are no further steps.

4. Doors

- 4.1 Low-location lighting shall lead to the exit door handle. To prevent confusion, no other doors shall be similarly marked.
- 4.2 Where sliding doors are fitted in partitions in accordance with Article 19.11(2) and in bulkheads in accordance with Article 19.02(5), the direction of opening shall be indicated.

5. Signs and markings

- 5.1 All escape route signs shall be of photoluminescent material or marked by electric lighting. The dimensions of such signs and markings shall be commensurate with the rest of the LLL system.
- 5.2 Low-location lighting exit signs shall be provided at all exits. The signs shall be located within the prescribed area on the side of the exit doors where the handle is located.
- 5.3 All signs shall contrast in colour to the background (wall or floor) on which they are installed.
- 5.4 Standardised symbols (for example those described in IMO Decision A.760(18)) shall be used for the LLL.

6. Photoluminescent systems

- 6.1 PL strips shall be no less than 0,075 m wide. Narrower strips may however be used if their luminance is increased proportionally to compensate for their width.
- 6.2 Photoluminescent materials shall provide at least 15 mcd/m² measured 10 minutes after the removal of all external illuminating sources. The system shall then continue to provide luminance values greater than 2 mcd/m² for 20 minutes.

- 6.3 Any PL system materials shall be provided with not less than the minimum level of ambient light necessary to charge the PL material to meet the above luminance requirements.

7. Electrically powered systems

- 7.1 Electrically powered systems shall be connected to the emergency switchboard required by Article 19.10(4) so as to be powered by the main source of electrical power under normal circumstances and also by the emergency source of electrical power when the latter is in operation. For the purpose of dimensioning the capacity of the emergency source of electrical power the EP systems shall be included in the list of emergency consumers.
- 7.2 Electrically powered systems shall either switch on automatically or be capable of being activated by means of a single operation at the steering position.
- 7.3 Where electrically powered systems are installed, the following standards of luminance shall be applied:
1. the active parts of electrically powered systems shall have a minimum luminance of 10 cd/m^2 ;
 2. the point sources of miniature incandescent lamps shall provide not less than 150 mcd mean spherical intensity with a spacing of not more than 0,1 m between lamps;
 3. the point sources of light-emitting-diode systems shall have a minimum peak intensity of 35 mcd. The angle of half-intensity cone shall be appropriate to the likely track directions of approach and viewing. Spacing between lamps shall be no more than 0,3 m; and
 4. for electroluminescent systems, these shall function for 30 minutes from the instant when the main power supply to which it was required to be connected by Section 7.1 fails.
- 7.4 All EP systems shall be arranged so that the failure of any single light, lighting strip, or battery will not result in the marking being ineffective.
- 7.5 Electrically powered systems shall meet the requirements of Article 10.19 for vibration and heat testing. By way of derogation from Article 10.19(2)(c) the heat test may be conducted at a reference ambient temperature of $40 \text{ }^\circ\text{C}$.
- 7.6 Electrically powered systems shall meet the electromagnetic compatibility requirements laid down in Article 10.20.
- 7.7 Electrically powered systems shall provide a type of minimum protection of IP 55 in accordance with European Standard EN 60529 : 2014.

8. Testing

8.1 The luminance of the LLL must be checked by an expert

- a) before being put into service for the first time,
- b) before being put back into service after any major modification or repair,
- c) regularly, at least every five years,

Checks as referred to in subsection (c) above may also be carried out by a competent person trained in safety guidance systems.

8.2 An inspection certificate shall be issued, signed by the expert or competent person and showing the date of the inspection.

8.3 If, after a single measurement, the luminance does not meet the requirements set out in this instruction, measurements are to be taken at least ten equidistant points. If over 30 % of the measurements do not meet the requirements set out in this instruction, the safety guidance systems must be replaced. If 20 % to 30 % of the measurements do not meet the requirements set out in this instruction, the safety guidance systems are to be checked again within one year.

ESI-III-5 SUITABLE GAS WARNING EQUIPMENT

(Article 19.15(8))

1. In accordance with Sections 32.02(2) and 32.05(5) (in each case transitional provision to Article 19.01(2)(e)) liquefied gas installations for domestic purposes on board existing passenger vessels may only be operated until the first renewal of the inland navigation vessel certificate after 1 January 2045, on condition that a gas warning equipment in accordance with Article 19.15(8) is available. In accordance with Article 19.15(9), liquefied gas installations for domestic purposes may in the future also be installed on passenger vessels put into operation for the first time and of which the length does not exceed 45 m, if such warning equipment is installed at the same time.
2. In accordance with Articles 32.02(2) and 32.05(5) (in each case transitional provision to Article 19.15(8)) this gas warning equipment shall be installed on the first renewal of the certificate in accordance with Article 17.15.
3. The gas warning equipment consists of sensors, equipment and pipes and shall be considered suitable if it at least meets the following prescribed requirements:
 - 3.1 Requirements to be met by the system (sensors, equipment, pipes):
 - 3.1.1 Gas warning shall be given at the latest when reaching or exceeding one of the following values:
 - a) 10 % lower explosion limit (LEL) of a propane-air mixture; and
 - b) 30 ppm CO (carbon monoxide).
 - 3.1.2 The time until activation of the alarm for the whole system must not exceed 20 s.
 - 3.1.3 The limit values mentioned in numbers 3.1.1 and 3.1.2 must not be adjustable.
 - 3.1.4 The test gas production shall be so designed that any interruption or obstruction is detected. Any falsification due to air admission or loss of test gas as a consequence of leakage shall be avoided or detected and reported.
 - 3.1.5 The equipment shall be designed for temperatures ranging from –10 to 40 °C and an air humidity ranging from 20 to 100 %.
 - 3.1.6 The gas warning equipment must be self-monitoring. It shall be impossible to switch off the equipment unauthorised.
 - 3.1.7 Gas warning equipment supplied by the onboard power supply network shall be buffered against power failure. Battery-powered appliances shall be provided with a warning device indicating a reduction of the battery voltage.

3.2 Requirements to be met by the equipment:

3.2.1 The equipment shall consist of an evaluation and display unit.

3.2.2 The alarm indicating that the limit values in (3.1.1)(a) and (b) have been reached or exceeded shall be given optically and acoustically, both in the room monitored and in the wheelhouse or at any other permanently manned location. It shall be clearly visible and audible even in operating conditions with the highest noise level. It shall be clearly distinguishable from any other acoustic and optical signals in the room to be protected. The acoustic alarm shall also be clearly audible with closed connecting doors at the entrances and in neighbouring rooms.

The acoustic alarm may be silenced after activation, the optical alarm may only be cancelled if the limit values fall below those given mentioned in (3.1.1).

3.2.3 It shall be possible to separately detect and clearly assign the reports indicating that the limit values in (3.1.1)(a) and (b) have been reached or exceeded.

3.2.4 If the appliance has a special status (start-up, failure, calibration, parameterisation, maintenance etc.), this shall be indicated. The failure of the whole system or one of the components shall be indicated by an alarm in analogy to (3.2.2). The acoustic alarm may be silenced after activation, the optical alarm may only be cancelled if the failure is removed.

3.2.5 If it is possible to issue different reports (limit values, special status) it shall also be possible to discern them separately and to assign them clearly. If necessary, a collective signal shall be displayed indicating that it is not possible to issue all reports. In this case, the reports shall be issued by order of priority, beginning with the report with the highest safety relevance. The display of the reports which cannot be issued shall be possible by pressing a button. The order of priority shall be evident from the documentation of the appliance.

3.2.6 The equipment shall be so designed that unauthorised interference is not possible.

3.2.7 In all cases where detection and alarm equipment are used, the control alarm unit and indicating device shall be operable from outside the spaces containing the gas storage and consuming appliances.

3.3 Requirements to be met by the sensors/sampling devices:

3.3.1 In every room with consuming appliances, sensors of the gas warning equipment shall be provided in the vicinity of these appliances. The sensors/sampling devices shall be installed in such a way that gas accumulation is detected before the limit values mentioned in (3.1.1) are reached. Arrangement and installation of the sensors shall be documented. The selection of the locations shall be substantiated by the manufacturer or the specialised firm installing the equipment. The pipes of the sampling devices should be as short as possible.

3.3.2 The sensors shall be easily accessible in order to enable regular calibration, maintenance and safety checks.

3.4 Requirements to be met by the installation:

3.4.1 The whole gas warning equipment shall be installed by a specialised firm.

- 3.4.2 For the installation, the following aspects shall be taken into consideration:
- a) local ventilation systems;
 - b) structural arrangements (design of walls, partitions etc.) facilitating or complicating the accumulation of gases; and
 - c) prevention of adverse effects due to mechanical damage, water or heat damage.
- 3.4.3 All pipes of the sampling devices shall be arranged in such a way that condensate formation is not possible.
- 3.4.4 The installation shall be effected in such a way that any unauthorised tampering is not possible.
4. Calibration and inspection of gas leak detectors, replacement of parts with limited service life.
- 4.1 Gas leak detectors shall be calibrated and inspected by an expert or a competent person as directed by the manufacturer:
- a) before being put into service for the first time,
 - b) before being put back into service after any major modification or repair,
 - c) regularly,
- A calibration and inspection certificate shall be issued, signed by the expert or competent person and showing the date of the inspection.
- 4.2 Parts of the gas warning equipment which have a limited service life must be replaced before expiry of their specified operational life.
- 5 Marking
- 5.1 All appliances shall at least show the following information in a clearly legible and indelible form:
- a) name and address of the manufacturer,
 - b) legal marking,
 - c) designation of series and type,
 - d) if possible, serial number,
 - e) if required, any advice indispensable for safe use; and
 - f) for each sensor the indication of the calibration gas.
- 5.2 Elements of the gas warning equipment with limited restricted lifespan shall be clearly marked as such.

6. Manufacturer's details relating to the gas warning equipment:
 - a) complete instructions, drawings and diagrams concerning the safe and proper operation as well as the installation, starting-up and maintenance of the gas warning equipment;
 - b) operating instructions containing at least:
 - aa) measures to be taken in the case of an alarm or error indication;
 - bb) safety measures in the case of non-availability (e.g. calibration, inspection, interruption); and
 - cc) persons responsible for installation and maintenance,
 - c) instructions for calibration before the starting-up, and for routine calibration, including time intervals to be followed,
 - d) supply voltage,
 - e) type and meaning of the alarms and displays (e.g. special status),
 - f) information concerning the detection of operating difficulties and the removal of faults,
 - g) type and scope of the replacement of components with limited lifespan; and
 - h) type, scope and time interval of the inspections.

ESI-III-6

COUPLING SYSTEMS AND COUPLING DEVICES FOR CRAFT SUITABLE FOR PROPELLING OR BEING PROPELLED IN A RIGID ASSEMBLY

(Articles 21.01, 21.02, 21.06, 21.07)

In addition to the requirements of Chapter 21, the relevant provisions of the navigational authority regulations in force in the Member States shall be observed.

1. General requirements

- 1.1 Every coupling system shall guarantee the rigid coupling of all the craft in a convoy, i.e. under foreseen operating conditions the coupling device shall prevent longitudinal or transversal movement between the vessels, so that the assembly can be seen as a 'nautical unit'.
- 1.2 The coupling system and its components shall be safe and easy to use, enabling craft to be coupled rapidly without endangering personnel.
- 1.3 The forces arising from foreseen operating conditions shall be properly absorbed and safely transmitted into the vessel's structure by the coupling system and its components.
- 1.4 A sufficient number of coupling points shall be available.

2. Coupling forces and dimensioning of coupling devices

The coupling devices of convoys and formations of vessels to be authorised shall be dimensioned so as to guarantee sufficient safety levels. This condition is deemed to be fulfilled if the coupling forces determined according to (2.1), (2.2) or (2.3) are assumed to be the tensile strength for the dimensioning of the longitudinal coupling components.

- 2.1 Coupling points between pusher and pushed lighters or other craft:

$$F_{SB} = 270 \cdot P_B \cdot \frac{L_S}{B_S} \cdot 10^{-3} [kN]$$

- 2.2 Coupling points between pushing motor cargo vessel or pushing motor tanker and pushed craft:

$$F_{SF} = 80 \cdot P_B \cdot \frac{L_S}{h_K} \cdot 10^{-3} [kN]$$

- 2.3 Coupling points between pushed craft:

$$F_{SL} = 80 \cdot P_B \cdot \frac{L'_S}{h'_K} \cdot 10^{-3} [kN]$$

A value of 1200 kN is deemed to be sufficient for the maximum coupling force for a pushing craft at the coupling point between the first pushed craft and the craft coupled ahead of it, even if formula in (2.3) produces a higher value.

For the coupling points of all other longitudinal connections between pushed craft, the dimensioning of the coupling devices shall be based on the coupling force determined according to formula in (2.3).

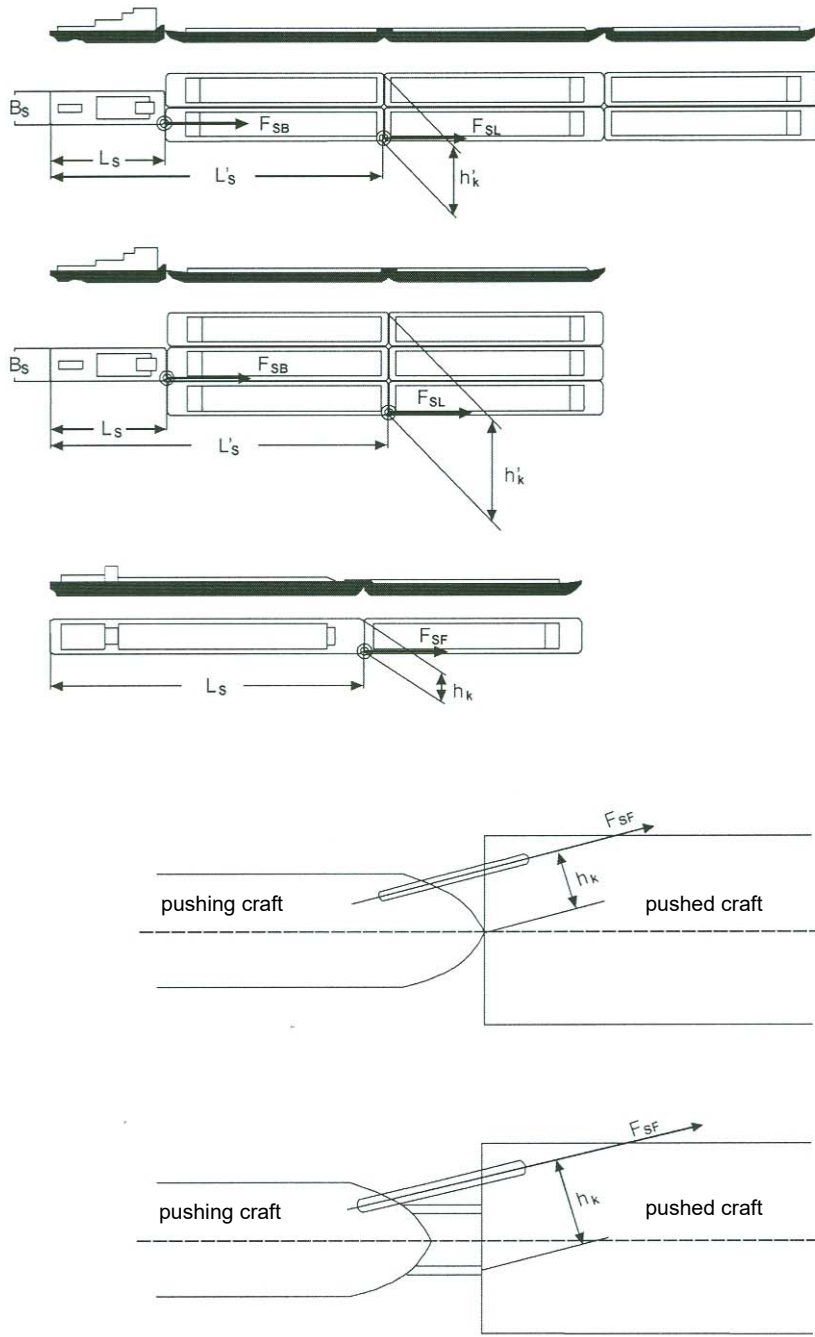

Where:

F_{SB}, F_{SF}, F_{SL}	[kN]	Coupling force of the longitudinal connection;
P_B	[kW]	Installed power of the propulsion engine;
L_S	[m]	Distance from the stern of the pusher or pushing craft to the coupling point;
L'_S	[m]	Distance from the stern of the pushing craft to the coupling point between the first pushed craft and the craft coupled ahead of it;
h_K, h'_K	[m]	Respective lever arm of the longitudinal connection;
B_S	[m]	Width of the pushing craft;
270 and 80	$\left[\frac{kN}{kW} \right]$	Empirically established values for the conversion of installed power to thrust while ensuring adequate levels of safety.

- 2.4.1 For the longitudinal coupling of individual craft at least two coupling points shall be used. Each coupling point shall be dimensioned for the coupling force determined according to (2.1), (2.2) or (2.3). If rigid coupling components are used, a single coupling point may be authorised if that point ensures secure connection of the craft.

The tensile strength of the cables shall be selected according to the foreseen number of windings. There shall be no more than three windings at the coupling point. Cables shall be selected according to their intended use.

- 2.4.2 In the case of pushers with a single pushed lighter, formula in (2.2) can be used to determine the coupling force if such pushers have been authorised to propel several such lighters.
- 2.4.3 Sufficient numbers of bollards or equivalent devices shall be available and be capable of absorbing the coupling forces arising.

3. Special requirements for articulated couplings

Articulated couplings shall be designed so as to also ensure a rigid coupling between craft. Compliance with the requirements of Chapter 5 shall be checked during navigation tests with a rigid convoy in accordance with Article 21.06.

The drive unit of the articulated coupling shall enable a satisfactory return from the articulated position. The requirements of Articles 6.02 to 6.04 shall be applied *mutatis mutandis*, hence when a powered drive unit is used, a second independent drive unit and energy source shall be available in the event of failure.

It shall be possible to operate and monitor the articulated coupling (its articulated movement, at least) from the wheelhouse, the requirements of Articles 7.03 and 7.05 shall be applied *mutatis mutandis*.

ESI-III-7
FUEL TANKS ON FLOATING EQUIPMENT

(Article 8.05(1) and Article 22.02(1)(d))

According to Article 8.05(1), fuel tanks shall form an integral part of the hull or shall be firmly attached to it.

Fuel tanks for engines of working gear on floating equipment do not have to form an integral part of the hull or be firmly attached to it. Mobile tanks may be used, provided that they comply with the following conditions:

1. The capacity of these tanks shall not exceed 1000 litres.
2. It shall be possible to attach the tanks sufficiently firmly and to earth them.
3. The tanks shall be made from steel of a sufficient wall thickness and shall be installed in a drip tray. The latter shall be designed to prevent leaking fuel contaminating the waterways. The drip tray may be dispensed with if double-skin tanks with a leak protection or leakage warning system are used and which are filled only via an automatic delivery valve. The provisions of (3) shall be deemed to be fulfilled if the construction of a tank has been certified and approved according to the regulations of a Member State.

An appropriate entry shall be made in the inland navigation vessel certificate.

ESI-III-8 RECREATIONAL CRAFT

(Article 26.01(2))

1. General

Recreational craft of up to 24 metres length, that are placed on the market, have to comply with the requirements of Directive 2013/53/EU. According to Article 7 in conjunction with Article 2 of Directive (EU) 2016/1629 (respectively Rhine Vessel Inspection Regulations), recreational craft having a length of 20 metres or more shall carry an inland navigation vessel certificate attesting the craft's compliance with the technical requirements of this Standard. Since double inspection or certification for certain equipment, arrangements and installations of newly built recreational craft which can result from certain provisions in Article 26.01 of Standard should be avoided, this Instruction gives information on those requirements listed in Article 26.01 that are already sufficiently covered under Directive 2013/53/EU.

2. Requirements in Article 26.01 which are already covered under Directive 2013/53/EU

For recreational craft subject to Directive 2013/53/EU the inspection body shall as regards to the issuance of the inland navigation vessel certificate (initial inspection) not require further inspection or certification except the requirements of Article 26.01(2)(a) to (f), provided that no modifications to the craft have been carried out since it has been placed to the market, and the Declaration of Conformity refers to the following harmonised Standards or their equivalence:

Article 8.08(2) : EN ISO 15083 : 2023, (Bilge pumping)

Article 8.10 : EN ISO 14509-1 : 2018 and
EN ISO 14509-3 : 2018, (Noise emission)

Recreational craft subject to Directive 2013/53/EU, or previously Directive 94/25/EC, shall also comply with the technical requirements of Directive 2013/53/EU, respectively Directive 94/25/EC, in a permanent manner. If a recreational craft is subject to a periodic inspection, the inspection body may check whether the recreational craft is still in the technical condition that existed at the time of the initial inspection.

If the inspection body finds that the recreational craft no longer meets the technical requirements of the Directive 2013/53/EU (or previously Directive 94/25/EC), it may require that the compliance with these technical requirements is restored. Alternatively, the recreational craft may be inspected in accordance with the provisions of Article 26.01(1), in which case it may be considered to be in service, subject to the provisions applying the transitional provisions.

ESI-III-9
PROOF OF BUOYANCY, TRIM AND STABILITY OF THE SEPARATED PARTS
OF A VESSEL

(Article 28.04, in conjunction with Article 27.02 and Article 27.03)

1. When proving the buoyancy, trim and stability of the parts of a vessel which have been separated in accordance with Article 28.04(2)(a), it shall be assumed that both parts were partly or fully unloaded beforehand or that containers extending beyond the hatch coaming were suitably protected from slipping.
2. For each of the two parts, the following requirements shall therefore be met when calculating stability in accordance with Article 27.03 (Limit conditions and method of calculation for proof of stability for the transport of secured containers):
 - metacentric height \overline{MG} shall be not less than 0,50 m,
 - there shall be a residual safety clearance of 100 mm
 - the speed to be taken into account shall be 7 km/h,
 - the wind pressure shall be taken to be 0,01 t/m².
3. The heeling angle ($\leq 5^\circ$) does not have to be complied with for the parts of the vessel separated in accordance with Article 28.04(2) since this angle — derived from the coefficient of friction — was specified for non-secured containers.

The heeling lever resulting from the free surfaces of liquids shall be taken into account in accordance with the formula given in Article 27.02(1)(e).
4. The requirements set out in (2) and (3) shall also be deemed to have been met if, for each of the two parts, the stability requirements set out in Section 9.1.0.95.2 of ADN regulation are met.
5. The proof of stability of separated parts of the ship can be based on the assumption that they are homogeneously loaded because - if not already the case - this can be achieved prior to separation, or else because the vessel is going to be largely unloaded

ESI-III-10
EQUIPMENT FOR VESSELS TO BE OPERATED ACCORDING TO STANDARDS
S1 OR S2

(Articles 31.01, 31.02 and 31.03)

1. General introduction

According to Article 31.01, vessels which are intended to be operated according to standards S1 and S2 shall comply with the provisions of Chapter 31. The inspection body shall confirm in the inland navigation vessel certificate that the vessel complies with these provisions.

These provisions are supplementary equipment requirements which apply in addition to the requirements with which a vessel has to comply for the inland navigation vessel certificate to be issued. Provisions of Chapter 31 which might be interpreted in different ways will be clarified in this instruction.

2. Article 31.02 – Standard S1

2.1 (1) – Arrangement of the propulsion system

If a vessel is fitted with a directly reversible main engine, the compressed air system which is required to reverse the direction of thrust shall:

- a) be kept permanently pressurised by an automatically adjusting compressor; or
- b) when an alarm is triggered in the wheelhouse be pressurised by means of an auxiliary engine which can be started from the steering position. If the auxiliary engine has its own fuel tank, there shall — in accordance with Article 7.04(11)(e) — be a warning device in the wheelhouse to indicate if the level of filling is not sufficient to ensure further safe operation.

2.2 (2) – Bilge levels in the main engine room

If a bow steering system is necessary to comply with the manoeuvring requirements of Chapter 5, the room containing the bow steering system shall be deemed to be a main engine room.

2.3 (3) – Automatic fuel supply

2.3.1 If the propulsion system has a daily-supply tank,

- a) its contents shall be sufficient to ensure an operation period of the propulsion system of 24 hours, assuming a consumption of 0,25 litres per kW per hour;
- b) the fuel supply pump for refilling the daily-supply tank shall be operated continuously; or
- c) the fuel supply pump shall be fitted with:
 - a switch that automatically switches on the fuel supply pump when the daily-supply tank reaches a certain low level, and
 - a switch that automatically switches off the fuel supply pump when the daily-supply tank is full.

2.3.2 The daily-supply tank shall have a level alarm device which meets the requirements of Article 7.04(11)(e).

2.4. (4) – No particular force required for the steering system

Hydraulically operated steering systems fulfil this requirement. Manually operated steering systems shall not require a force of more than 160 N in order to be operated.

2.5 (5) – Visual and acoustic signals required under way

Visual signs do not include cylinders, balls, cones or double cones required under national or international navigational authority regulations.

2.6 (6) – Direct communication and communication with the engine room

2.6.1 Direct communication shall be deemed to be ensured if:

- a) direct visual contact is possible between the wheelhouse and the control positions for the winches and bollards on the fore section or the stern of the vessel and in addition the distance from the wheelhouse to these control positions is not more than 35 m; and
- b) the accommodation is directly accessible from the wheelhouse.

2.6.2 Communication with the engine room shall be deemed to be ensured if the signal referred to in Article 7.09(3) second sentence, can be operated independently from the switch referred to in Article 7.09(2).

2.7 (7) – Cranks and similar rotating means of operation

These include:

- a) manually operated windlasses (the maximum force required shall be deemed to be that when the anchors are hanging freely);
- b) cranks for lifting hatches;
- c) cranks on mast and funnel winches.

These do not include:

- a) warping and coupling winches;
- b) cranks on cranes, unless intended for ship's boats.

2.8 (10) – Ergonomic arrangement

The provisions are deemed to be fulfilled if:

- a) the wheelhouse is arranged in accordance with European Standard EN 1864 : 2008; or
- b) the wheelhouse is designed for radar navigation by one person; or
- c) the wheelhouse meets the following requirements:
 - aa) the control units and monitoring instruments are in the forward field of vision and within an arc of not more than 180° (90° to starboard and 90° to port), including the floor and ceiling. They shall be clearly legible and visible from the normal position of the helmsman;

- bb) the main control units such as the steering wheel or steering lever, the engine controls, the radio controls, and the controls for the acoustic signals and the warning and manoeuvring signals required under national or international navigational authority regulations, as appropriate, shall be arranged in such a way that the distance between the controls on the starboard side and those on the port side is not more than 3 m. The helmsman shall be able to operate the engines without letting go of the controls for the steering system and while still being able to operate the other controls such as the radio system, the controls for the acoustic signals and the warning and manoeuvring signals required under national or international navigational authority regulations, as appropriate;
- cc) the warning and manoeuvring signals required under national or international navigational authority regulations, as appropriate, are operated electrically, pneumatically, hydraulically or mechanically. By way of derogation, it may be operated by means of a tension wire only if safe operation from the steering position is possible in this way.

3. Article 31.03 – Standard S2

3.1 (1) – Motor cargo vessel or motor tanker operating separately

Motor cargo vessels or motor tankers that can prove that they are capable of pushing on the basis of the inland navigation vessel certificate, but which

- a) are not equipped with hydraulic or electric coupling winches, or
- b) whose hydraulic or electric coupling winches do not comply with the requirements in (3.3) of this instruction

come under standard S2 as a motor cargo vessel or a motor tanker operating separately. The following statement shall be entered under item 47 on the inland navigation vessel certificate: 'Standard S2 does not apply to the motor cargo vessel or the motor tanker when pushing'.

3.2 (3) – Pushed convoys

Motor cargo vessels or motor tankers that can prove that they are capable of pushing on the basis of the inland navigation vessel certificate and are equipped with hydraulic or electric coupling winches that fulfil the requirements of (3.3) of this instruction but which do not have their own bow thruster shall be given the standard S2 as motor cargo vessel or a motor tanker pushing a convoy. The entry 'Standard S2 does not apply to the motor cargo vessel or a motor tanker when operating separately' shall be entered under item 47 of the inland navigation vessel certificate.

3.3 (3), first sentence, and (4)(d), first sentence — Special winches or equivalent devices for tensioning the cables (coupling devices)

The coupling devices required are the minimum equipment specified in accordance with Article 21.01(2) which, according to (2.1) and (2.2) of instruction ESI-III-6 (longitudinal connections), serve to take up the coupling forces and which meet the following requirements:

- a) the device shall provide the tensioning force required for the coupling only by mechanical means;
- b) the controls for the device shall be located on the device itself. By way of derogation, remote control is permitted provided that:
 - the person operating the device has an unobstructed direct view of the device from the control position,

- there is a device at the control position to prevent unintentional operation,
 - the device has an emergency stop;
- c) the device shall have a braking device which acts immediately if the controls are released or the motive force fails;
- d) it shall be possible for the coupling cable to be released manually if the motive force fails.

3.4 (3), second sentence, and (4)(d), second sentence — Operating the bow thruster

The control for operating the bow thruster shall be permanently installed in the wheelhouse. The requirements of Article 7.04(8) shall be complied with. The electric cabling to operate the bow thruster shall be permanently installed up to the fore section of the pushing motor cargo vessel, the pushing motor tanker or the pusher.

3.5 (4) – Equivalent manoeuvrability

Equivalent manoeuvrability is ensured by a propulsion system consisting of:

- a) a multi-propeller drive and at least two independent propulsion systems with similar power output;
- b) at least one cycloidal propeller;
- c) at least one rudder propeller; or
- d) at least one 360° water-jet propulsion system.

ESI-III-11
MATERIALS COMPLYING WITH THE EQUIVALENT REGULATIONS INSTEAD
OF THE CODE FOR FIRE TEST PROCEDURES

(Articles 1.01(6.4), (6.5) and 19.11(1), (2) and (6))

The European Standards series EN 13501 (meaning EN 13501-1 : 2018, EN 13501-2 : 2023, EN 13501-3 : 2009, EN 13501-4 : 2016, EN 13501-5 : 2016 and EN 13501-6 : 2022) and the European Standard EN 45545-2 : 2023 are acceptable test methods for determining the non-flammability of materials, that a material is flame-retardant, or fire resistant, as alternative to the Code for Fire Test Procedures in accordance with Article 19.11(1) of ES-TRIN.

The recognition of other regulations of one of the Member States shall follow the same approach to achieve an acceptable safety level.

1. All inland vessels

1.1 Flame retardant (as defined in Article 1.01(6.5))

1.1.1 Products which have been tested according to **FTP Code Annex 1, Part 5** are deemed to comply with ES-TRIN (Article 19.11(1)(c)).

1.1.2 Products that have been tested according to European Standards **EN 13501-1 : 2018** may be accepted depending on its classification and use.

Classification **B** (*or higher*) is considered acceptable.

Classification **C** (*or lower*) is not considered acceptable.

1.1.3 Products that have been tested according to European Standard **EN 45545-2 : 2023** may be accepted depending on its classification and use.

Classification **HL2** or **HL3** for requirement R1 are considered equivalent

Classification **HL3** for requirement R10 (flooring) is considered equivalent.

1.2 Fumes or toxic gases in dangerous quantities

1.2.1 Products which have been tested according to **FTP Code Annex 1, Part 2, Appendix 1** are acceptable in accordance with ES-TRIN (Article 19.11(6)).

1.2.2 Products that have been tested according to European Standards series **EN 13501-1 : 2018** may be accepted depending on its classification and use.

Classification **s1** may be applied on floorings.

Classification **s2** may be applied on any internal surface (other than floorings).

Classification **s3** is not acceptable.

- 1.2.3 Products that have been tested according to European Standard **EN 45545-2 : 2023** may be accepted depending on its classification and use.

Classification **HL2** or **HL3** for requirement R1 are considered acceptable or equivalent.

Classification **HL3** for requirement R10 (flooring) is considered equivalent.

1.3 Non-combustible materials (as defined in Article 1.01(6.4))

- 1.3.1 Products which have been tested according to **FTP Code Annex 1, Part 1** are deemed to comply with ES-TRIN.

- 1.3.2 Products that have been tested according to European Standard **EN 13501-1 : 2018** may be accepted depending on its classification and use.

Classification **A1** may be applied as non-combustible materials.

Classification **A2** can be described as 'limited combustibility' and may not be applied as non-combustible material.

Classification **B, C, D, E, F** can be described as 'combustible' and may not be applied as non-combustible material.

- 1.3.3 Products that have been listed in **European Commission decision 96/603/EC** (as amended) are acceptable without further testing.

1.4 Droplets

- 1.4.1 Materials for bulkhead, wall and ceiling linings and primary deck coverings shall not produce burning droplets during the test.

- 1.4.2 Products which have been tested according to **FTP Code Annex 1, Part 5** are deemed to comply with ES-TRIN.

- 1.4.3 Products that have been tested according to European Standard **EN 13501-1 : 2018** may be accepted depending on its classification and use.

Classification **d0** is required for all fire protection materials.

Classification **d1 and d2** are not acceptable.

- 1.4.4 Products that have been tested according to European Standard **EN 45545-2 : 2023** may be accepted depending on its classification and use.

Classification **HL2** or **HL3** for requirement R1 are considered acceptable.

2. Passenger vessels

- 2.1 Passenger vessels must comply with Article 19.11 which regards to fire protection.
- 2.2 Products which have been tested according to **FTP Code Annex 1, Part 3** are deemed to comply with ES-TRIN.
- 2.3 Materials which have been tested by an accredited test institution according to the European Standards **EN 13501-2 : 2023** and **EN 13501-3 : 2009** may be used on-board based on the following correlations.

FTP Code	EN 13501-2 : 2023 and EN 13501-3 : 2009
B0	E30
B15	combination of E30 and I15
A0	E60
A30	combination of E60 and I30
A60	combination of E60 and I60 (meaning EI60)

Remark 1: The integrity E is the ability of the material to withstand fire exposure on one side only, without the transmission of fire to unexposed side as a result of the passage of flames or hot gases. The classification for integrity (E) is acceptable based on the above table. Type A maintains integrity for 1 hour; on this basis, use of “the classification” E60 (i.e. 60 minutes) is accepted. Type B maintains integrity for 30 min; on this basis, use of “the classification” E30 (i.e. 30 minutes) is accepted.

Remark 2: The thermal insulation I is the ability of the material to withstand fire exposure on one side only, without the transmission of fire as a result of significant transfer of heat from the exposed side to the unexposed side. The classification for insulation (I) is equivalent to the specified period in which the required temperatures remain within the criteria (see Article 19.11(2)(b)(c)).

Remark 3: The above table indicates the minimum classification required under the European Standards series EN 13501. A higher combination of E and I classification is also acceptable.

ESI-III-12 ARRANGEMENTS OF METHANOL FUEL TANKS

(Annex 8, (2.2.3) to (2.2.6))

1. Illustration of typical tank arrangements in accordance with ES-TRIN, Annex 8, (2.2.3) and (2.2.4); other configurations are possible.

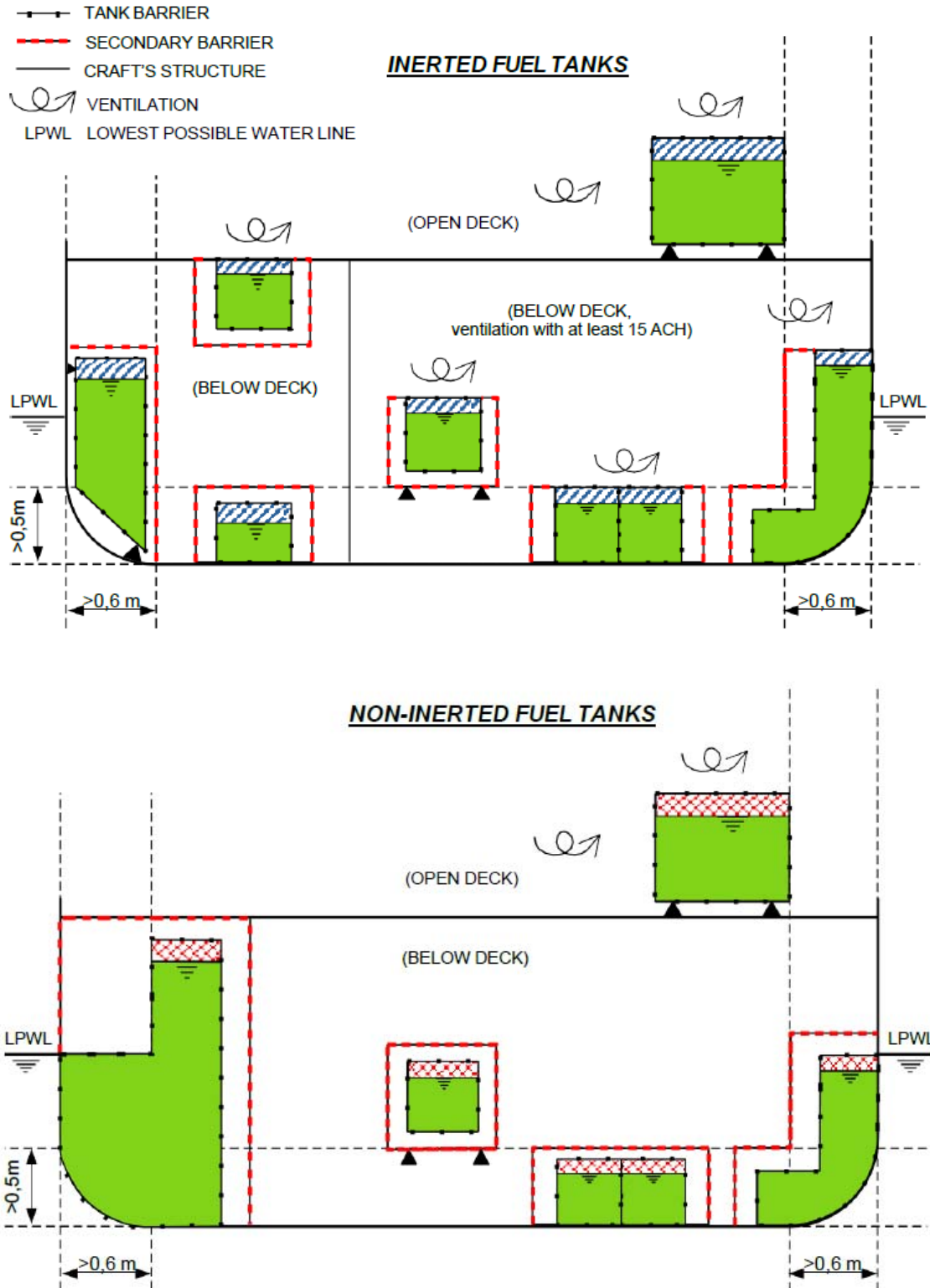

2. Illustration of typical pipe arrangements in accordance with ES-TRIN, Annex 8, (2.2.5) and (2.2.6); other configurations are possible.

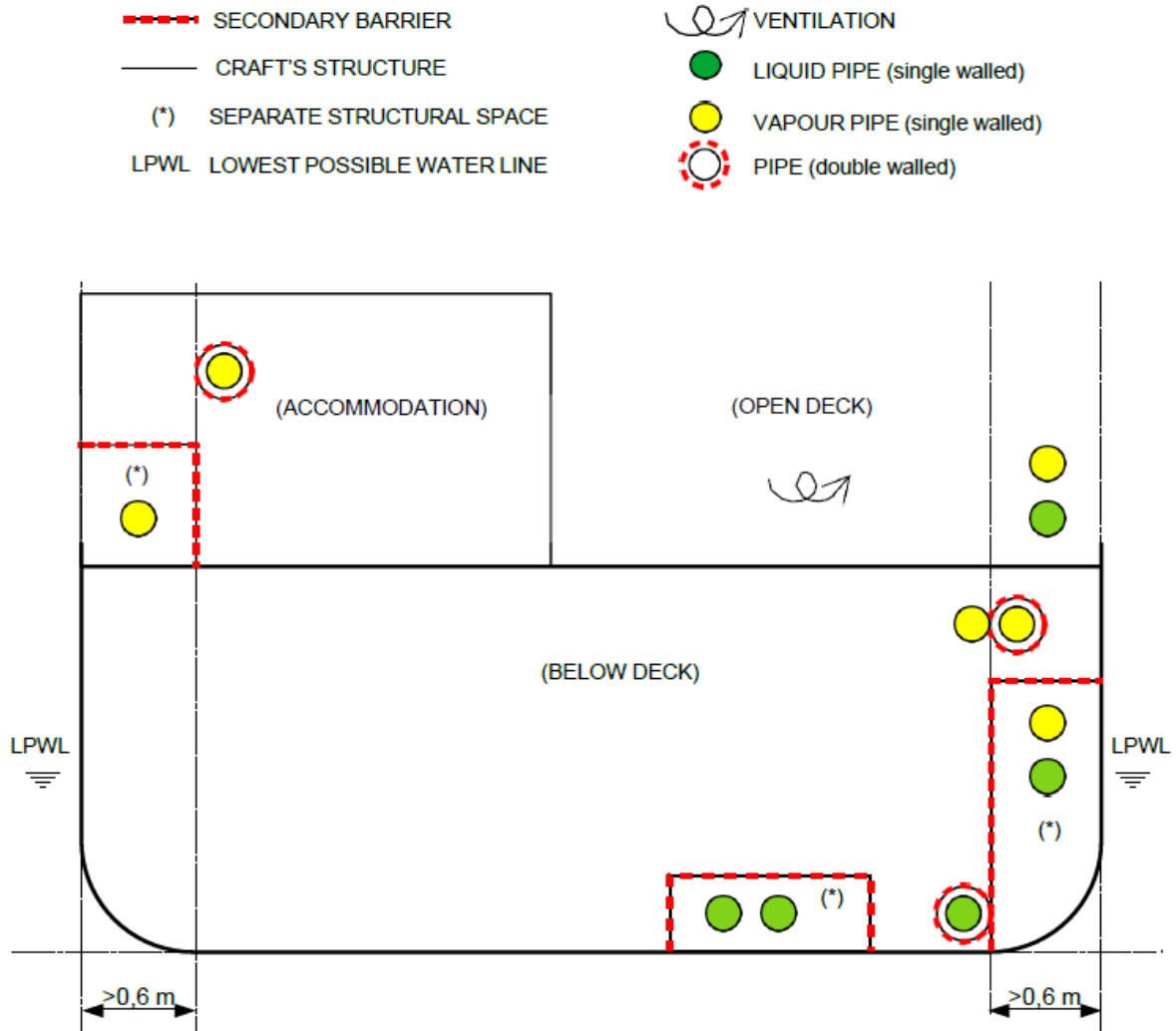

PART IV TRANSITIONAL PROVISIONS

ESI-IV-1 APPLICATION OF TRANSITIONAL PROVISIONS

(Chapters 19 to 30, Chapter 32 and Chapter 33)

1. Application of transitional provisions in joining together parts of craft

1.1 Principles

Where parts of different vessels are joined together, status quo protection shall be granted only for the parts which belong to the vessel which retains its inland navigation vessel certificate. Transitional provisions may therefore be invoked only for those parts. Other parts shall be treated as a newly built vessel.

1.2 Application of the transitional provisions in detail

1.2.1 Where parts of different vessels are joined together, transitional provisions may be invoked only for those parts which belong to the vessel which retains its inland navigation vessel certificate.

1.2.2 Parts which do not belong to the vessel which retains its vessel certificate shall be treated as a newly built craft.

1.2.3 After a vessel has had part of another vessel added to it, the former shall receive the ENI number of the craft, which retains its inland navigation vessel certificate as the converted craft.

1.2.4 Where an existing inland navigation vessel certificate is retained or a new inland navigation vessel certificate is issued for a craft after a conversion, the year of construction of the oldest part of the craft shall additionally be entered in the inland navigation vessel certificate.

1.2.5 If a new fore section is attached to a craft, the engine for the bow thruster system installed in the fore section shall also comply with the current requirements.

1.2.6 If a new stern section is attached to a vessel, the engines installed in the stern section shall also comply with the current requirements.

1.3 Examples

1.3.1 A vessel is put together from two older vessels (vessel 1 year of construction 1968; vessel 2 year of construction 1972). The whole of vessel 1 apart from the fore section is used; of vessel 2, the fore section is used. The assembled vessel receives vessel 1's inland navigation vessel certificate. The fore section of the assembled vessel must now be fitted inter alia with anchor niches.

- 1.3.2 A vessel is put together from two older vessels (vessel 1 year of construction 1975; vessel 2 year of construction 1958, oldest component 1952). The whole of vessel 1 apart from the fore section is used; of vessel 2, the fore section is used. The assembled vessel receives vessel 1's inland navigation vessel certificate. The fore section of the assembled vessel must now be fitted inter alia with anchor niches. The oldest component from the original vessel 2, with year of construction 1952, is additionally entered in the inland navigation vessel certificate.
- 1.3.3 The stern section of a vessel of year of construction 2001 is attached to a vessel of year of construction 1988. The engine of the vessel of year of construction 1988 is to remain in the vessel. In this case, the engine has to be type approved. The engine would also have to be type approved if it was the engine in the 2001 stern section.

2. Application of transitional provisions in the case of a change in the type of craft (intended use of the craft)

2.1 Principles

- 2.1.1 In any decision on the application of transitional provisions in the case of change of the type of craft (vessel type; intended use of the vessel), as regards to this Standard safety considerations shall be key.
- 2.1.2 It shall constitute a change in the type of craft if the safety requirements applying to the new type of craft are different from those for the old type of craft; this is so if special provisions of Chapters 19 to 25 and 27 to 30 of this Standard are applicable to the new type of craft which were not applicable to the old type of craft.
- 2.1.3 In the case of a change in the type of craft, all special provisions and all requirements specific to this type of craft shall be complied with fully; transitional provisions may not be invoked for these requirements. This also applies to parts which are taken over from the existing craft and come under these special requirements.
- 2.1.4 The conversion of a tanker into a dry cargo vessel shall not constitute a change in the type of craft as defined in 2.1.2.
- 2.1.5 In the case of conversion of a cabin vessel into a day-trip vessel, all new parts shall comply fully with the current requirements.

2.2 Application of the transitional provisions in detail

- 2.2.1 Article 32.02(2) (N.R.C.), resp. Article 33.02(2) applies to the parts of the craft that are renewed; hence new parts of the craft cannot be subject to the transitional provisions.
- 2.2.2 For the parts of the craft that are not converted, the transitional provisions shall continue to be applicable with the exception of parts according to 2.1.3, second sentence.
- 2.2.3 If the dimensions of the craft are modified, the transitional provisions no longer apply to those parts of the craft that are connected with this modification (e.g. distance of collision bulkhead, freeboard and anchor).

- 2.2.4 In the case of a change in the type of craft, the special requirements that only apply to the new type of craft shall be applicable. All parts and items of equipment that are affected by the conversion of the craft must satisfy the current requirements Part II and III of this Standard.
- 2.2.5 The craft shall then be granted a new or amended inland navigation vessel certificate and a note shall be made in items 7 and 8 of the certificate both of the original construction and of the conversion.

2.3 Examples

- 2.3.1 A cargo vessel (year of construction 1996) is converted into a passenger vessel. Chapter 19 of this Standard then applies to the whole vessel, without invoking transitional provisions. If the fore section is not modified either according to the conversion plans or in accordance with Chapter 19, the vessel does not need to present any anchor niches in accordance with Article 3.03.
- 2.3.2 A tug (year of construction 1970) is converted into a pusher. The physical conversion consists solely of changing the deck equipment and installing a pushing device. All transitional provisions for a 1970 vessel remain applicable, except for the Chapters 5, 7 (in part), Article 13.01 and Article 21.01.
- 2.3.3 A motor tanker (year of construction 1970) is converted into a pusher. The physical conversion consists of separating off the fore section and the cargo section, as well as changing the deck equipment and installing a pushing device. All transitional provisions for a 1970 vessel remain applicable, except for the provisions of Chapters 5, 7 (in part), Article 13.01 and Article 21.01.
- 2.3.4 A motor tanker is converted into a motor cargo vessel. The motor cargo vessel must comply with current workplace safety requirements, particularly those referred to in Article 14.04 of Chapter 14 of this Standard.

3. Application of transitional provisions in the case of conversion of passenger vessels

3.1 Application of the transitional provisions

- 3.1.1 Conversion measures that are necessary in order to comply with requirements of Chapter 19, no matter when they are carried out, shall not constitute conversion 'C' within the meaning of Article 32.02(2), Article 32.03(1) or Article 32.05(5), resp. Article 33.02 and Article 33.03, of this Standard.
- 3.1.2 In the case of conversion of a cabin vessel into a day-trip vessel, all new parts shall comply fully with the current requirements.

3.2 Examples

- 3.2.1 A passenger vessel (year of construction 1995) must have a second independent propulsion system installed by 1 January 2015 at the latest. If no other voluntary conversions are made on this passenger vessel, it is not necessary to carry out a stability calculation in accordance with the new requirements, but if there is an objective need for one, a stability calculation may be carried out in accordance with the original stability requirements of the RVIR or a Member State.

- 3.2.2 A passenger vessel (year of construction 1994, inland navigation vessel certificate last renewed 2012) will be extended by 10 m in 2016. In addition, this craft must be given a second independent propulsion system. Also, a new stability calculation will be necessary, which must be carried out in accordance with Chapter 19 for the one-compartment status and the two-compartment status.
- 3.2.3 A passenger vessel (year of construction 1988) receives a more powerful propulsion system including propellers. This is such a major conversion that a stability calculation is required. This must be carried out in accordance with current requirements.